

**IALA Recommendation O-139**  
**on**  
**The Marking of Man-Made Offshore Structures**

**Edition 2**

**December 2013**  
Edition 1: December 2008



10, rue des Gaudines  
78100 Saint Germain en Laye, France  
Telephone: +33 1 34 51 70 01 Fax: +33 1 34 51 82 05  
e-mail: [contact@iala-aism.org](mailto:contact@iala-aism.org) Internet: [www.iala-aism.org](http://www.iala-aism.org)

## Document Revisions

Revisions to the IALA Document are to be noted in the table prior to the issue of a revised document.

<b>Date</b>	<b>Page / Section Revised</b>	<b>Requirement for Revision</b>
December 2013	Entire document	Due to the technological and operational developments that occurred in the offshore structures activities in the sea, it was necessary to update this recommendation in order to respond to the identified marking.

## **Recommendation on The Marking of Man-Made Offshore Structures**

**(Recommendation O-139)**

### **THE COUNCIL:**

**RECALLING** the function of IALA with respect to Safety of Navigation, the efficiency of maritime transport and the protection of the environment;

**RECOGNISING** that there is an increase in new and emerging uses of ocean and coastal waters, subsoil and seabed, an increase of seaborne trade, increasing demands of energy resources, increasing recreational use and increasing pollution threats from both ocean uses and an expansion of coastal populations.

**RECOGNISING ALSO** that the number and types of man-made structures being built in the maritime environment are increasing.

**RECOGNISING ALSO** the need to provide consistency in marking different types of offshore structures which may be a danger to navigation.

**RECOGNISING ALSO** that it is a matter for a National Authority to decide on whether a man-made structure needs to be marked, depending on the risk involved and the level of traffic.

**RECOGNISING ALSO** that IMO Resolution A.672(16), dated 6th December 1989, established Guidelines and Standards for the Removal of Offshore Installations and Structures on the Continental Shelf and in the Exclusive Economic Zone, which incorporate requirements for such installations and structures, whilst being removed, to be marked in accordance with IALA Recommendations.

**RECOGNISING FURTHER** that marking is to improve the safety to navigation and protect the structures themselves.

**ADOPTS** the recommendation on the Marking of Man-Made Offshore Structures as set out in the following Sections.

**NOTING** that the content of recommendations for marking as outlined in IALA Recommendations:

O-114 “The Marking of Offshore Structures” Edition 1 May 1998

O-116 “The Marking of Aquaculture Farms” Edition 2 June 2007

O-117 “The Marking of Offshore Wind Farms” Edition 2 December 2004

O-131 “The Marking of Offshore Wave and Tidal Energy Devices” Edition 1 June 2005

have been withdrawn and are superseded by IALA Recommendation O-139.

**RECOMMENDS** that Members ensure that the marking of man-made structures conforms to the standards and practices specified in the following Sections of this recommendation.

\* \* \*

## Table of Contents

<b>Document Revisions</b>	<b>1</b>
<b>Recommendation on The Marking of Man-Made Offshore Structures</b>	<b>3</b>
<b>Table of Contents</b>	<b>4</b>
<b>Index of Figures</b>	<b>5</b>
<b>1. INTRODUCTION</b>	<b>7</b>
1.1 Scope	7
1.2 Field of Application	7
1.3 Information and promulgation	7
1.4 Emergency provisions and contingency plans	7
<b>2. MARKING OF OFFSHORE STRUCTURES</b>	<b>8</b>
2.1 MARKING OF OFFSHORE STRUCTURES / PLATFORMS IN GENERAL	8
2.1.1 General	8
2.1.2 Marking	9
2.1.3 Considerations during construction and decommissioning	10
2.2 MARKING OF OIL AND GAS PLATFORMS	11
2.3 MARKING OF OFFSHORE WINDFARMS	11
2.3.1 Marking of Isolated WTG, Meteorological Masts and other Individual Structures	12
2.3.2 Marking of Floating Wind Turbine Structures	13
2.3.3 Marking of Group of Structures (Offshore Wind Farms)	13
2.4 MARKING OF OFFSHORE WAVE AND TIDAL ENERGY DEVICES	14
The level of marking should be decided after a risk assessment has been conducted.	15
2.4.1 2.4.1 Marking	15
2.5 MARKING OF OFFSHORE AQUACULTURE FARMS	16
2.5.1 Marking Examples	17
<b>3. FUTURE REQUIREMENTS</b>	<b>19</b>
<b>4. DEFINITIONS AND ACRONYMS</b>	<b>20</b>
<b>APPENDIX 1 INVENTORY OF OFFSHORE STRUCTURES</b>	<b>21</b>
1. AQUACULTURE FARMS	21
2. ARTICULATED LOADING PLATFORM (ALP) (OIL & GAS PERMANENT INSTALLATIONS)	22
3. CALM (OIL & GAS PERMANENT INSTALLATIONS - LOADING / DISCHARGE BUOYS)	23
4. FLOATING PRODUCTION STORAGE OFFLOADER (FPSOS) (LOADING / DISCHARGE BUOYS)	24
5. FLOATING WIND TURBINE	24
6. FLOTEL (OIL & GAS TEMPORARY STRUCTURES)	25
7. LNG OFFLOADING POINTS	25
8. METEOROLOGICAL MASTS	26

<b>9. MINIMUM FACILITY PLATFORM (MFP)</b>	<b>26</b>
<b>10. OFFSHORE DOCKS / LOADING ISLANDS</b>	<b>27</b>
<b>11. PIPES</b>	<b>27</b>
<b>12. PRODUCTION PLATFORM / DRILLING RIGS</b>	<b>28</b>
<b>13. SEAPLANE BERTH</b>	<b>28</b>
<b>14. SEAWATER INTAKES / SEWAGE OUTFALLS</b>	<b>29</b>
<b>15. SINGLE POINT MOORING (SPM) (LOADING / DISCHARGE BUOYS)</b>	<b>29</b>
<b>16. TENSION LEG PLATFORM (TLP) (OIL &amp; GAS PERMANENT INSTALLATIONS)</b>	<b>30</b>
<b>17. TIDAL GENERATOR</b>	<b>31</b>
<b>18. TIDAL GENERATOR FIELD</b>	<b>31</b>
<b>19. UNDERWATER MANIFOLDS / OBSTRUCTIONS</b>	<b>32</b>
<b>20. WATER INJECTION PLATFORMS OR BOOSTER STATION (WIPS)</b>	<b>32</b>
<b>21. WAVE GENERATOR</b>	<b>33</b>
<b>22. WAVE GENERATOR FIELD</b>	<b>33</b>
<b>23. WIND GENERATOR</b>	<b>34</b>
<b>24. OFFSHORE WIND FARM</b>	<b>34</b>

## **Index of Figures**

Figure 1	Sample marking of an individual wind turbine	13
Figure 2	Sample marking of an OWF	14
Figure 3	– Wave and tidal devices	16
Figure 4	A. Rectangular Aquaculture Farms	18
Figure 4	B. Circular Aquaculture Farms	19
Figure 5	A fish farm	21
Figure 6	A diagram of an Articulated Platform	22
Figure 7	A Catenary Anchor Leg Mooring buoy	23
Figure 8	A Floating Production Storage Offloader	24
Figure 9	A floating wind turbine	24
Figure 10	An example of a Flotel	25
Figure 11	An LNG Offloading Point	25
Figure 12	Meteorological Masts	26
Figure 13	An example of a Minimum Facility Platform	27
Figure 14	Offshore docks / Loading Islands	27
Figure 15	Typical underwater piping	27
Figure 16	Underwater pipe maintenance	27
Figure 17	An example of a Production Platform	28
Figure 18	An example of a Seaplane berth	28
Figure 19	A Seawater Intake / Sewage Outfall	29
Figure 20	A Single Point Mooring buoy	29
Figure 21	A diagram of a Tension Leg Platform	30
Figure 22	Tidal Generators	31

Figure 23	A Tidal Generator Field	31
Figure 24	An example of an underwater obstruction	32
Figure 25	A Water Injection Platform	32
Figure 26	A Wave Generator	33
Figure 27	A Wave Generator Field	33
Figure 28	A Wind Generator	34
Figure 29	An Offshore Wind Farm	34

# Recommendation O-139

## The Marking of Man-made Offshore Structures

### 1. INTRODUCTION

There is increasing development of man-made structures at sea, which may affect shipping. These structures can be isolated or in groups, small or large, and close to or far from shipping routes.

IALA is monitoring the developments of these structures and will continue to create and update documentation as required to ensure clear and unambiguous marking of waterways for safe navigation, protection of the environment and protection of the structures themselves. Authorities facing problems in this field are invited to bring them to the attention of IALA to obtain advice on current practice.

The following sections of this Document detail the updated IALA Recommendations for the marking of each offshore structure type identified in Appendix 1, along with an inventory and examples of man-made offshore structures.

The marking of offshore structures as defined in these recommendations may be considered as a minimum requirement to ensure the safety of navigation in the vicinity of the structures, however, National Authorities may require more stringent marking.

#### 1.1 Scope

These recommendations are for the guidance and information of stakeholders such as National Authorities, Lighthouse Authorities, Aviation Authorities and other competent Authorities, Aids to Navigation providers, and the Contractors, Developers and Operators involved in each type of the structures mentioned in the following sections. They are further called National Authorities in this Recommendation.

#### 1.2 Field of Application

The guidance contained in this document applies to all structures fixed in position temporarily or permanently which extend above or below the surface of the sea and which are obstructions to navigation, e.g. structures used for drilling or exploring for oil and/or minerals, oil production platforms, oil well protective jackets, renewable offshore energy installations, ocean data platforms or offshore aquaculture farms.

#### 1.3 Information and promulgation

National Authorities must ensure that all stakeholders are informed of installed Aids to Navigation (AtoN) and markings in accordance with these Recommendations. These are published in nautical charts and publications and by promulgation of Maritime Safety Information (MSI).

#### 1.4 Emergency provisions and contingency plans

- a. In case of main power failure, an adequate backup system is recommended to maintain the function and availability of AtoN, including Racon and AIS, for time specified by the National Authority; typically 96 hours.
- b. AtoN and AtoN systems should have availability in accordance with IALA Recommendation O-130 on Categorisation and Availability Objectives for Short Range AtoN and Guideline 1035 on Availability and Reliability of AtoN.
- c. Remote monitoring of the AtoN system is recommended.
- d. National Authorities are responsible for providing Maritime Safety Information (MSI) when an operator reports any AtoN malfunction.

- e. Operators of offshore structures are recommended to develop contingency and emergency response plans which address the possibility of individual devices breaking loose and becoming floating hazards.
- f. Operators are recommended to have a reliable maintenance and AtoN defect response regime in place to ensure the required availability targets are met. This will include having the necessary AtoN spares on hand, with provision made at the design stage, where necessary, to ensure safe access.

## **2. MARKING OF OFFSHORE STRUCTURES**

Man Made Offshore structures present very different characteristics. Therefore, these structures have been grouped as follows:

- Section 2.1: Offshore Structures in General
- Section 2.2: Oil and Gas Platforms
- Section 2.3: Offshore Wind Farms
- Section 2.4: Wave and Tidal Energy Devices
- Section 2.5: Aquaculture Farms

### **2.1 MARKING OF OFFSHORE STRUCTURES / PLATFORMS IN GENERAL**

#### **2.1.1 General**

The marking requirements defined in this section must be complemented with those in sections 2.2 to 2.5 for the specific types of offshore structures / platforms.

Consultation between the stakeholders should take place at an early stage. In general, development of all structures mentioned in this section must not prejudice the safe use of Traffic Separation Schemes, Inshore Traffic Zones, recognised sea-lanes and safe access to anchorages, harbours and places of refuge.

On a case-by-case basis, National Authorities may consider establishing Exclusion or Safety Zones and Areas to be Avoided in order to prohibit or restrict vessels from entering areas of Offshore Structures in general. Such information must be identified on the nautical charts and publications and promulgated through Maritime Safety Information (MSI).

The National Authority shall bear in mind that the marking recommendations herein may be adjusted based on risk assessments that consider traffic density, proximity to ports, proximity to dangers, tidal considerations and other factors.

In order to avoid confusion from a high-density of AtoN (and other general lighting), it is recommended that full consideration be given to the use of synchronised lights, different light characters and varied light ranges.

There has been some evidence that sea-bed scouring at the bases of offshore renewable energy installations in areas of strong tides or currents has resulted in significant deposits of material in other locations. National Authorities may consider fitting depth-monitoring devices to such installations to measure scour. This may need to be considered when approving wave and tidal energy extraction proposals / locations.

Power cables between offshore energy devices and the Offshore Sub Station, and between the Offshore Sub Station and the shore should be sufficiently trenched to avoid exposure from scouring / sand migration or trawling activities. Where burial depth is not achieved additional marking requirements are recommended.



### 2.1.2 Marking

The general rules for the marking of Offshore Structures are as follows:

- 1 It is recommended that the lights:
  - a Are located not less than 6 metres and not more than 30 metres above Highest Astronomical Tide (HAT);
  - b Have a minimum nominal range of 10 Nautical Miles, taking background lighting into account;
  - c Are synchronized with a flash character according to Mo (U) W  $\leq 15s$ ;
  - d Have a vertical divergence of the projected beam such that the light will be visible from the immediate vicinity of the structure to the maximum luminous range of the light.
- 2 If implemented, it is recommended that fog signals:
  - a Are located not less than 6 metres and not more than 30 metres above HAT;
  - b Have a minimum range of 2 Nautical miles;
  - c Have the character Mo (U) 30s with a minimum duration for the short blast of 0.75 seconds;
  - d Are operated when the meteorological visibility is 2 Nautical miles or less - a Visibility Detector will typically be used.
- 3 Where there is a requirement to identify a particular structure, a radar beacon (Racon) may be fitted. The character and code length shall be determined by the National Authority.
- 4 The National Authority may consider that a group of structures located close together can be marked as one single platform or structure.
- 5 The National Authority may consider that buoys or beacons are placed to mark the perimeter of a group of structures, to mark channels through a group of structures, or to mark any fixed structure while being erected or dismantled. The characteristics of such marks shall be determined by the National Authority in accordance with the IALA Maritime Buoyage System (MBS).
- 6 Where underwater obstructions, such as submerged wells or pipelines, are considered to be a hazard to surface borne vessels, it is recommended that they are adequately marked in accordance with the MBS.
- 7 The Hydrographic Office must be informed of the marking, location and extent of any offshore structure, to permit the appropriate charting.
- 8 Notices to Mariners must be issued to publicise the establishment of an offshore structure(s) / field. The Notice to Mariners has to include the marking, location and extent of such structure(s) / fields.
- 9 The National Authority should be satisfied that the selected lighting has a suitable Nominal Range and sufficient autonomy with the ability to over-winter – especially in higher latitudes.
- 10 The air navigation authorities may require additional marking of the structure(s).

The table below lists the marking recommendations and considerations for offshore structures:

* = RECOMMENDED + = TO BE CONSIDERED	Lights (white)	Lights (yellow)	Subsidiary Lights (red)	Intermediate Lights (yellow)	Fog Signal	Radar Beacon	AIS AtoN	Floating AtoN
Offshore Oil or Gas Platform – Temporary or Fixed	*		*		+	+	+	+
Floating Production Storage Offloading	*		+		+	+	+	
Floating Petrochemical Offloading Points / Single Point Mooring	*		+		+	+	+	
Aquaculture		*				+	+	*
Meteorological Mast	*				+	+	+	+
Minimum Facility Platform	*		+		+	+	+	+
Offshore Docks / Loading Islands	*		*		+	+	+	+
Underwater Pipes, Underwater Manifolds	+							+
Isolated Tidal / Wave Generator	*		+		+	+	+	+
Tidal/Wave Generator Field		*			+	+	+	*
Offshore Wind Farm		*		+	+	+	+	+
Isolated WTG	*				+	+	+	+
OWF Transformer / Sub-Station	*		+		+	+	+	

### 2.1.3 Considerations during construction and decommissioning

It is essential to consider the marking of offshore structures during the different phases of their existence, i.e. construction, operation and decommissioning, when the structure may be a hazard to navigation.

During the construction and decommissioning of Offshore Structures, it is recommended that working areas are established and marked as appropriate. National Authorities shall also consider the use of guard ships and / or temporary VTS in areas of high traffic density.

MSI must be promulgated in advance of and during any offshore structure / field construction or decommissioning.

When decommissioning such devices, it is recommended that the National Authority ensures that the operator / contractor remove all obstructions, so that the seabed is verified as being returned to its original depth and topography.

In the event that an obstruction remains which constitutes a danger to navigation, then it is recommended to mark the location based on risk assessment.

## 2.2 MARKING OF OIL AND GAS PLATFORMS

This section supplements the general rules for marking defined in section 2.1 and must be read in conjunction with it.

The Offshore Structures mentioned in this section are recommended to be marked as a single unit, a block or field, as appropriate, as follows:

- 1 Any structure shall be marked at night by one or more white lights so constructed and fixed as to ensure that at least one light is visible upon approaching the structure from any direction. Minimum nominal range is to be 10 Nautical miles.
- 2 Subsidiary red flashing lights shall also be provided and show the same characteristics as the main white lights, i.e. synchronized Mo (U) R  $\leq 15s$ . These are to be located to mark the horizontal extremities of the structure, excepting those marked with white lights, as well as interconnecting bridges. Minimum nominal range is to be 3 Nautical miles.
- 3 Each structure, where practicable, displays identification panels with black letters or numbers 1 metre high on a yellow background visible in all directions. These panels shall be easily visible in daylight as well as at night, either by using appropriate illumination or retro-reflecting material.

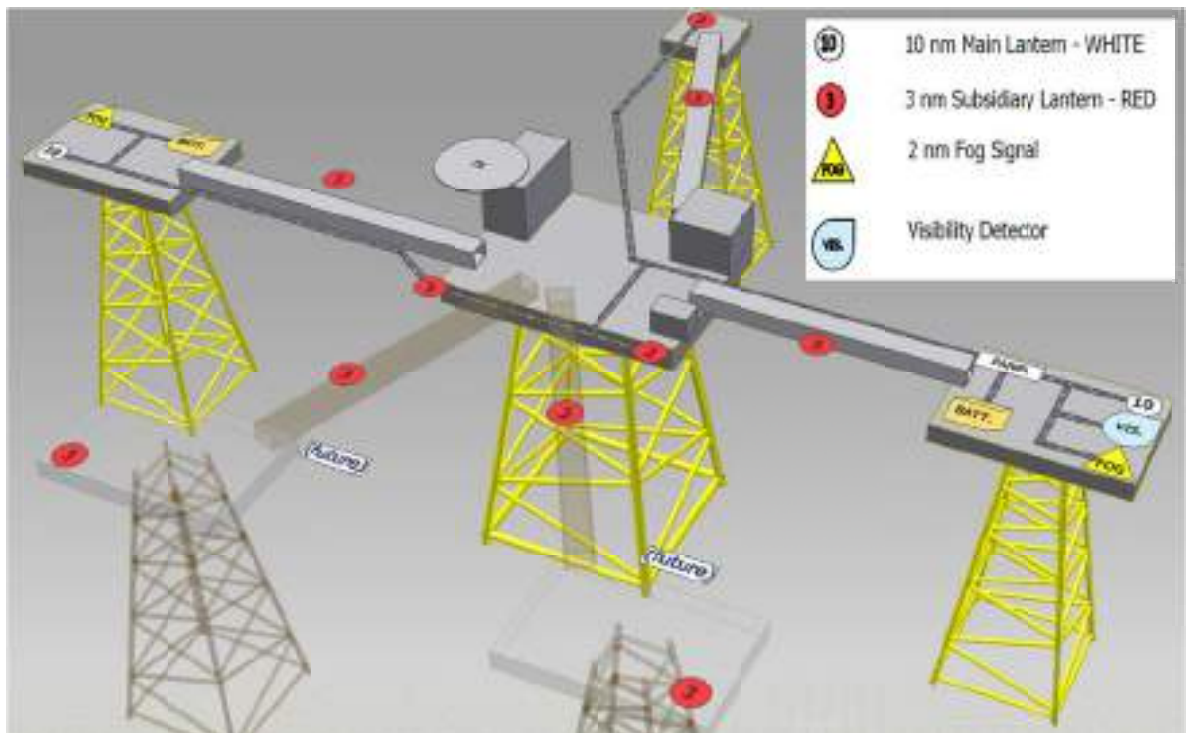

## 2.3 MARKING OF OFFSHORE WINDFARMS

This section supplements the general rules for marking defined in section 2.1 and must be read in conjunction with it.

When mentioning Offshore Wind Farms (OWF), the following are included: Meteorological Mast, Wind Turbine Generator (WTG) and Offshore Transformer / Sub-Station.

It is recommended that each structure, where practicable, displays identification panels with black letters or numbers 1 m high on a yellow background visible in all directions. These panels shall be easily visible in daylight as well as at night, either by using illumination or retro-reflecting material.

The structures should be painted yellow all around from the level of HAT up to 15 metres. On a case-by-case assessment alternative marking, where applicable, may include horizontal yellow bands of not less than 2 metres in height and separation. The addition of retro-reflective material may be considered (see figure 1).

When using working lights, such as down lighting on ladders and access platforms, they must not reduce the conspicuity of marking lights.

National Authorities should consider that:

- a OWF structures may affect shipborne and shore based radar systems, which in some cases through inherent system limitations, cause interference strong enough to produce significant degradation of the radar display;
- b Passage close to an OWF boundary, or within the OWF itself, could affect vessels' capability to manoeuvre;
- c The safety of navigation shall be ensured when approving an OWF;
- d Marking lights should be visible from all directions in the horizontal plane.

Consideration may also be given to the provision of fog signals where appropriate, taking into account the prevailing visibility, topography and vessel traffic conditions. The range of such a fog signal should not be less than two 2 Nautical miles.

### 2.3.1 Marking of Isolated WTG, Meteorological Masts and other Individual Structures

It is recommended that these structures:

- a. Are marked with a white light flashing Mo (U) W  $\leq 15s$ , and with a nominal range of 10 Nautical miles;
- b. Have AtoN mounted below the lowest point of the arc of the rotor blades. They shall be located at a height of at least 6 metres above HAT;
- c. Have AtoN that comply with IALA Recommendations and have an availability of not less than 99.0% (IALA Category 2).

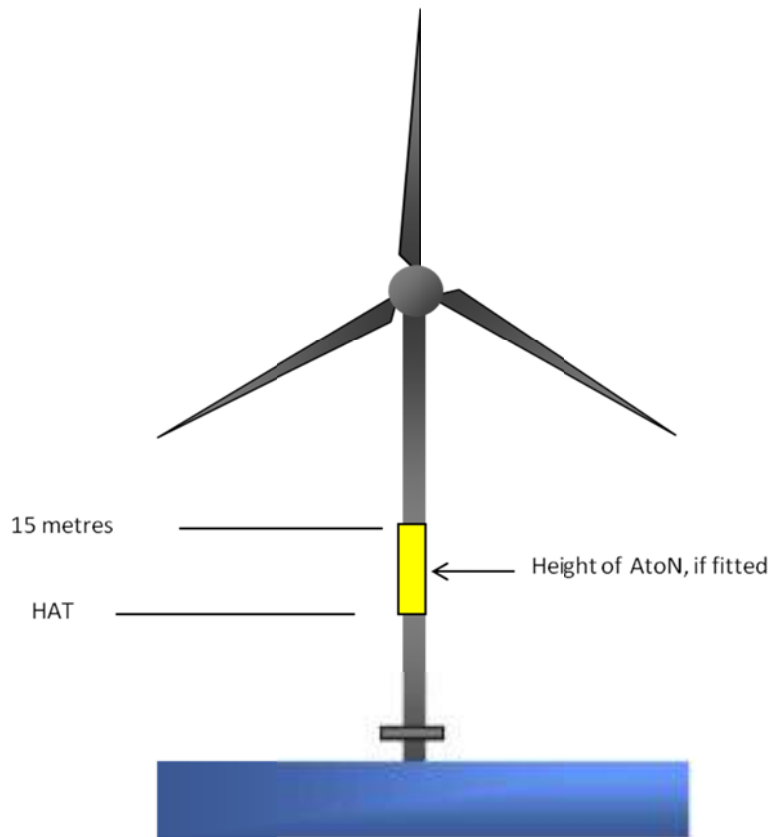

Figure 1 Sample marking of an individual wind turbine

### 2.3.2 Marking of Floating Wind Turbine Structures

Due to the specific movement of the floating wind structures, it is recommended that:

- a National Authorities take into account the interaction between aviation lights and the shipping in the area;
- b The marine lights should have a larger vertical divergence compared to a fixed structure, in order to maximize visibility at range to the mariner (e.g. 30° at 50%).

### 2.3.3 Marking of Group of Structures (Offshore Wind Farms)

A Significant Peripheral Structure (SPS) is the 'corner' or other significant point on the periphery of the OWF. It is recommended that:

- a These lights display a Special Mark characteristic, flashing yellow, with a nominal range of 5 Nautical miles;
- b The National Authority may consider the synchronisation of all SPS;
- c In the case of a large or extended OWF, the distance between SPS should not normally exceed 3 Nautical miles.

It is recommended that Intermediate Peripheral Structures (IPS) selected on the periphery of an OWF:

- a Are marked with flashing yellow lights;
- b The flash character of these lights shall be distinctly different from those displayed on the SPS, with a nominal range of 2 Nautical miles;
- c Have a lateral distance between IPS or the nearest SPS which will not normally exceed 2 Nautical Miles.

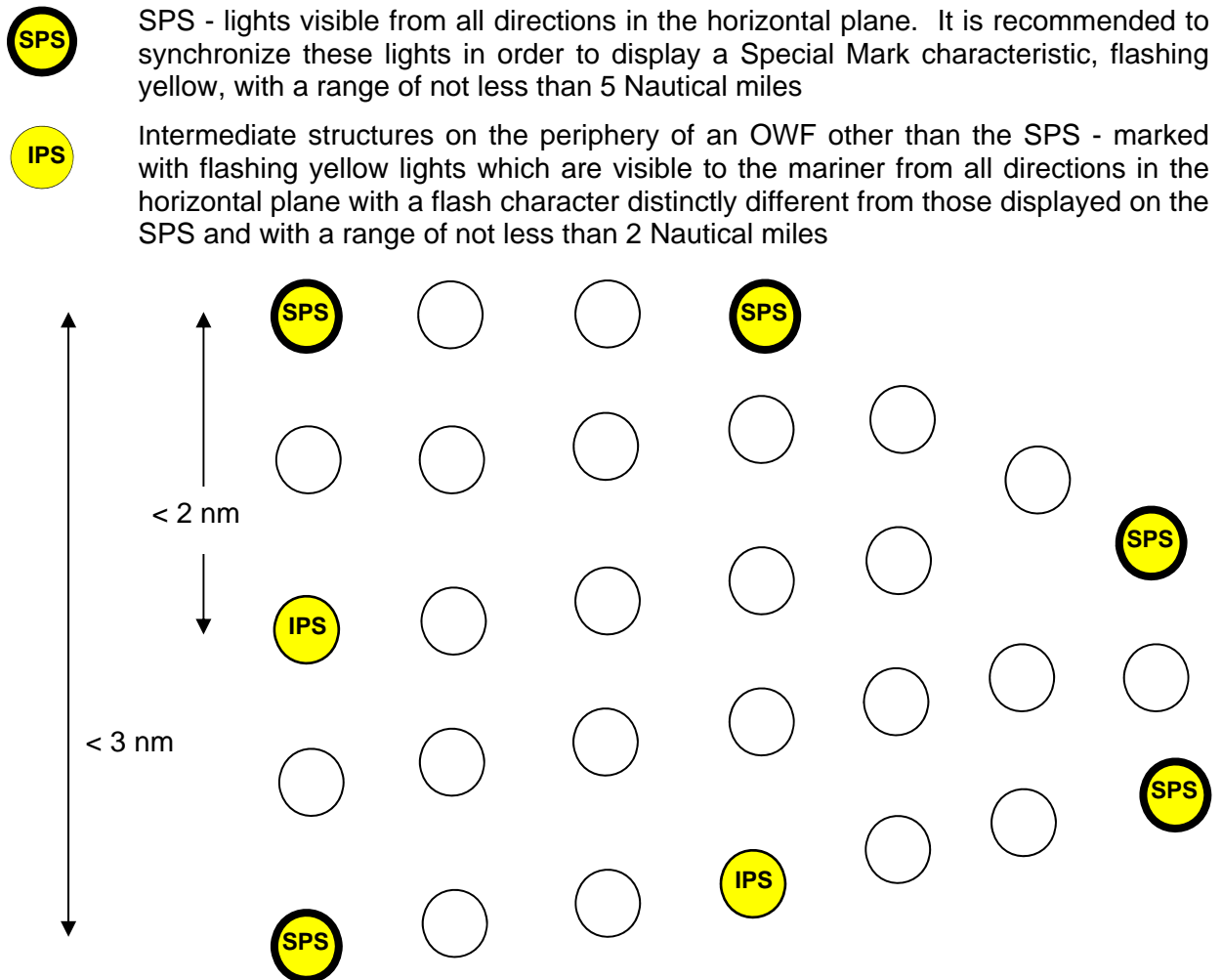

Figure 2 Sample marking of an OWF

Depending on the marking, lighting and lateral separation of the peripheral structures, the additional marking of the individual structures in general within an OWF may be considered as follows:

- Lighting or marking of each structure;
- Unlit individual structures can be made more conspicuous with retro-reflective areas;
- Use of flashing yellow lights with a nominal range of 2 Nautical Miles;
- Racons;
- AIS AtoN.

An Offshore Transformer / Sub-Station or a Meteorological Mast, if considered to be a composite part of the OWF, shall be included as part of the overall OWF marking. If not considered to be within the OWF block it shall be marked as an isolated offshore structure (see 2.3.1).

## 2.4 MARKING OF OFFSHORE WAVE AND TIDAL ENERGY DEVICES

This section supplements the general rules for marking defined in section 2.1 and must be read in conjunction with it.

Wave and Tidal Energy Devices include: Tidal Generator, Tidal Generator field, Wave Generator, Wave Generator field as defined in Appendix 1.

It must be borne in mind that many wave and tidal devices are low freeboard floating structures moored to the seabed. They may be moored in deep or shallow water and some may be located on the seabed or just below the surface. Surface piercing and subsurface elements may extend laterally beyond the surface elements. This could include shared moorings and mid-water connections between units that may also carry electricity, control signals, hydraulics or pneumatics associated with the units.

When identifying the marking requirements, it must be taken into consideration that some tidal devices:

- a. Have fast-moving sub-surface elements such as whirling blades;
- b. Do not allow for safe under keel clearance (UKC).

The level of marking should be decided after a risk assessment has been conducted.

#### 2.4.1 2.4.1 Marking

Wave and Tidal energy extraction devices should be marked as a single unit or as a block or field as follows:

- 1 When structures are fixed to the seabed or in the water column and extend above the surface, they shall be marked in accordance with the guidance contained in Section 2.3.
- 2 It is recommended that:
  - a Subject to the proper risk assessment, areas containing on surface or sub-surface wave or tidal devices are marked by appropriate AtoN. In addition, radar reflectors, retro-reflecting material, Racons and / or AIS transponders should be considered where the level of traffic and degree of risk requires;
  - b The lit AtoN must be visible to the mariner from all relevant directions in the horizontal plane, by day and by night;
  - c To improve the effectiveness of the lighting and taking into account background lighting, synchronisation can be used;
  - d Taking the results of a risk assessment into account, lights must have an appropriate nominal range and vertical divergence;
  - e Individual wave and tidal energy devices within a site that extend above the surface are painted yellow above the waterline. If navigation is permitted within the site, marking of individual devices may be required;
  - f If marked, the individual devices should have flashing yellow lights. The flash character of such lights must be sufficiently different from those displayed on the boundary lights with a nominal range of not less than 2 Nautical miles;
  - g Floating AtoN should be located outside the moorings of the floating structures.
- 3 Based on risk assessment, a single wave or tidal energy extraction structure, standing alone, may be marked as follows:
  - An Isolated Danger Mark.
  - Special Mark.
- 4 Specific guidance to small craft needs early consideration.
- 5 The AtoN described herein should comply with IALA Recommendations and have an appropriate availability, normally not less than 99.0% (IALA Category 2).
- 6 Recommended principles for marking of area for wave energy devices are referred to in the figure below. The National Authority may consider the distances between lit and unlit special marks on a case by case basis and on a risk assessment.

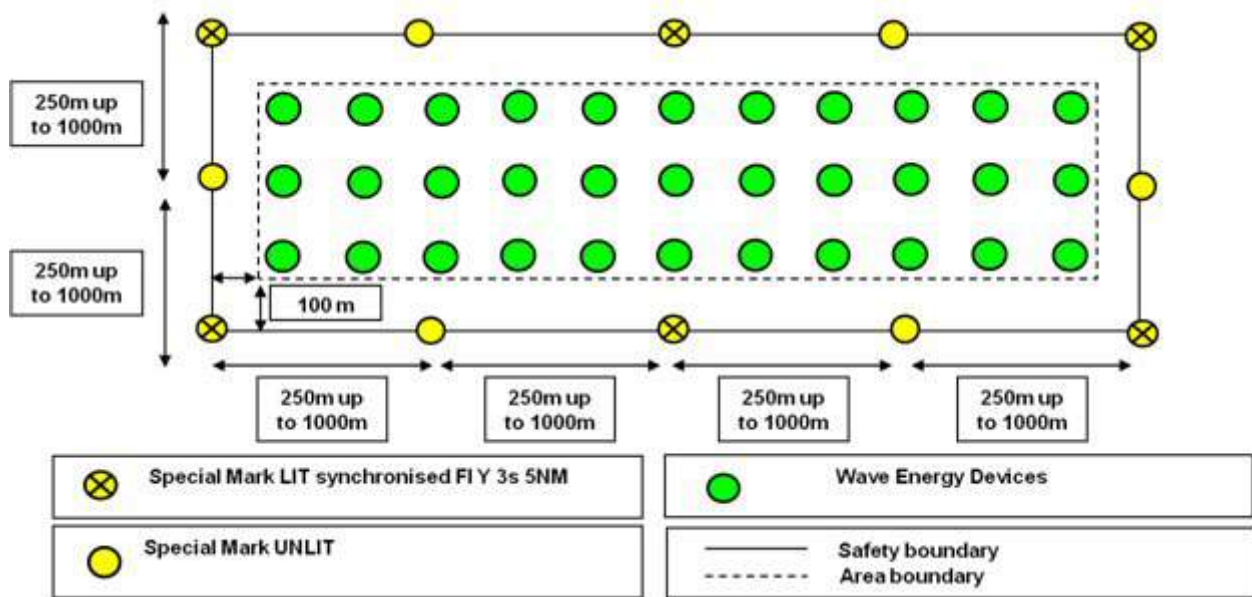

Figure 3 Marking of Wave and tidal devices

## 2.5 MARKING OF OFFSHORE AQUACULTURE FARMS

This section supplements the general rules for marking defined in section 2.1 and must be read in conjunction with it.

The farm, or group of farms, should be marked depending on their size, extent and location. In some cases it may be sufficient to mark only part of the perimeter, or the centre. The use of Racons or AIS AtoN may also be considered.

Recommended principles for marking of area aquaculture farms are referred to in the table below. National Authority may consider the distances between lit and unlit special marks on a case by case basis and on a risk assessment.

It should be borne in mind that many aquaculture farms are low freeboard floating structures that are moored to the seabed. They may be moored in deep or shallow water and some may be located on the seabed or just below the surface. Surface piercing and subsurface elements may extend laterally beyond the surface elements. This could include shared moorings and mid-water connections between units that may also carry electricity, control signals, hydraulics or pneumatics associated with the units.

The National Authority should bear in mind that the marking recommendations herein may be adjusted in consideration of traffic density, proximity to ports, proximity to dangers, tidal considerations and other factors.

It is recommended to mark offshore aquaculture farms as follows:

1. Aquaculture farms are normally marked by Special Marks;
2. If there is a requirement for vessel traffic between aquaculture farms, then such channels are normally marked by Lateral Marks;
3. If the prevailing situation warrants, Cardinal Marking alone may be used to direct vessel traffic away from the aquaculture farm(s);
4. It is recommended that areas of aquaculture farms are marked by appropriate AtoN. In addition radar reflectors, retro reflecting material, Racons and AIS AtoN may be considered;



5. To improve the effectiveness of marking and taking into account background lighting, synchronisation of the lights is recommended. Taking the results of a risk assessment into account, lights must have an appropriate nominal range;
6. Specific guidance to small craft needs early consideration;
7. The AtoN described herein should comply with IALA Recommendations and have an appropriate availability, normally not less than 99.0% (IALA Category 2).

#### 2.5.1 Marking Examples

Examples can be found in the following tables and figures that illustrate the minimum recommended marking arrangement with Special Marks.

- It is recommended that Rectangular Aquaculture Farms are marked according to the length of their sides.

<i>Example</i>	<i>X Axis (m)</i>	<i>Y Axis (m)</i>	<i>Area (m<sup>2</sup>)</i>	<i>Minimum Marking Requirements</i>
A	≤ 500	≤ 500		One light in centre of farm (consider radar reflector)
B	≤ 2 500	≤ 500		One light on each sea corner; one daymark on each coast corner (consider radar reflector)
C	≤ 500	≤ 2 500		One light on one sea corner; one light on the diagonally opposite coast corner; one daymark on one sea corner and one daymark on the diagonally opposite corner (consider radar reflector)
D	> 500	≤ 2 500	≤ 1 250 000	One light on diagonally opposite corners; daymark on diagonally opposite corners (consider radar reflector)
E	> 900	≤ 2 500	> 1 250 000	One light on each corner (consider radar reflector)

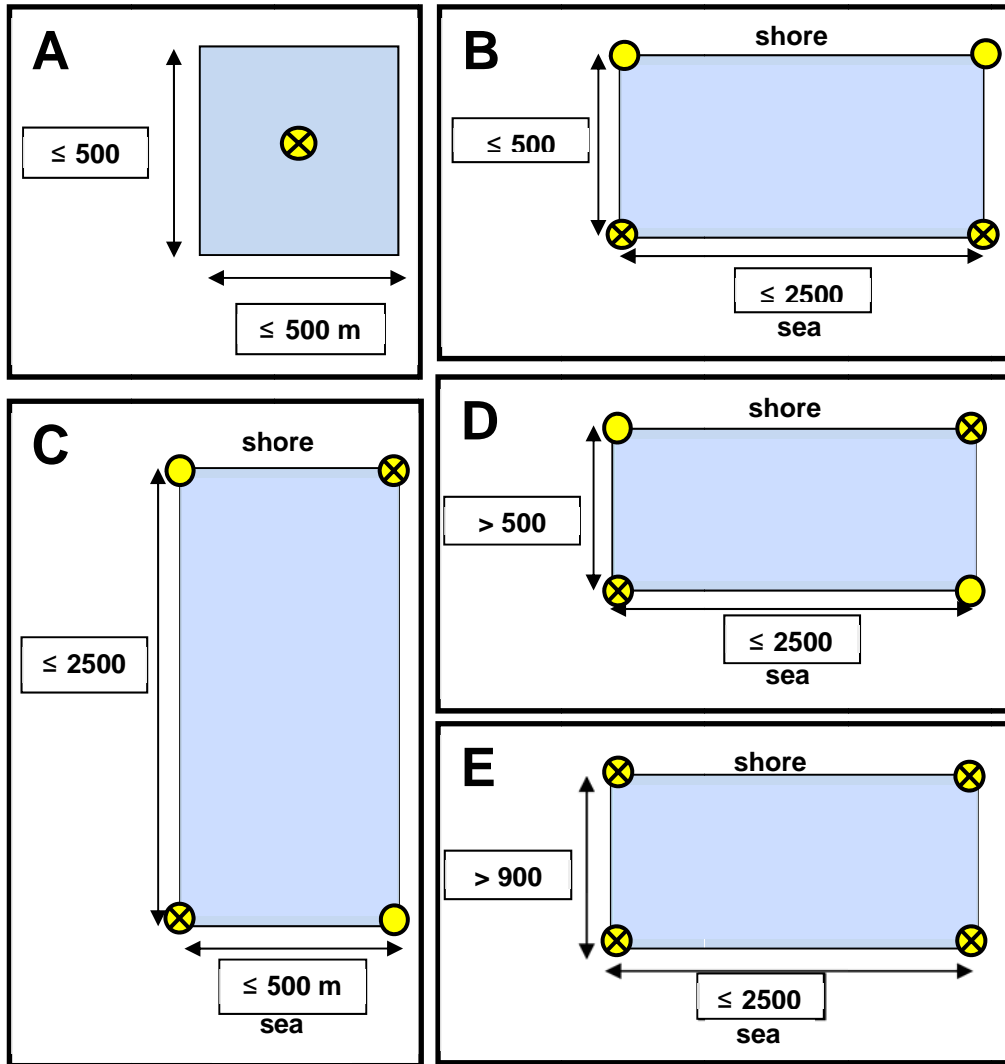
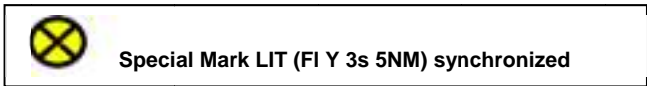

Figure 4 A. Rectangular Aquaculture Farms

- Circular Aquaculture Farms should be marked according to their diameter.

Example	Diameter (m)	Diameter (m)	Minimum Marking Requirements
F		$\leq 500$	One light in centre of farm (consider radar reflector)
G	$> 500$	$\leq 1000$	Two lights $180^\circ$ apart on the circumference; two daymarks positioned $90^\circ$ to the lights (consider radar reflector)
H	$> 1000$	$\leq 2000$	Three lights $120^\circ$ apart on the circumference (consider radar reflector)
I	$> 2000$		Three lights $120^\circ$ apart on the circumference, three daymarks positions $60^\circ$ to the lights (consider radar reflector)

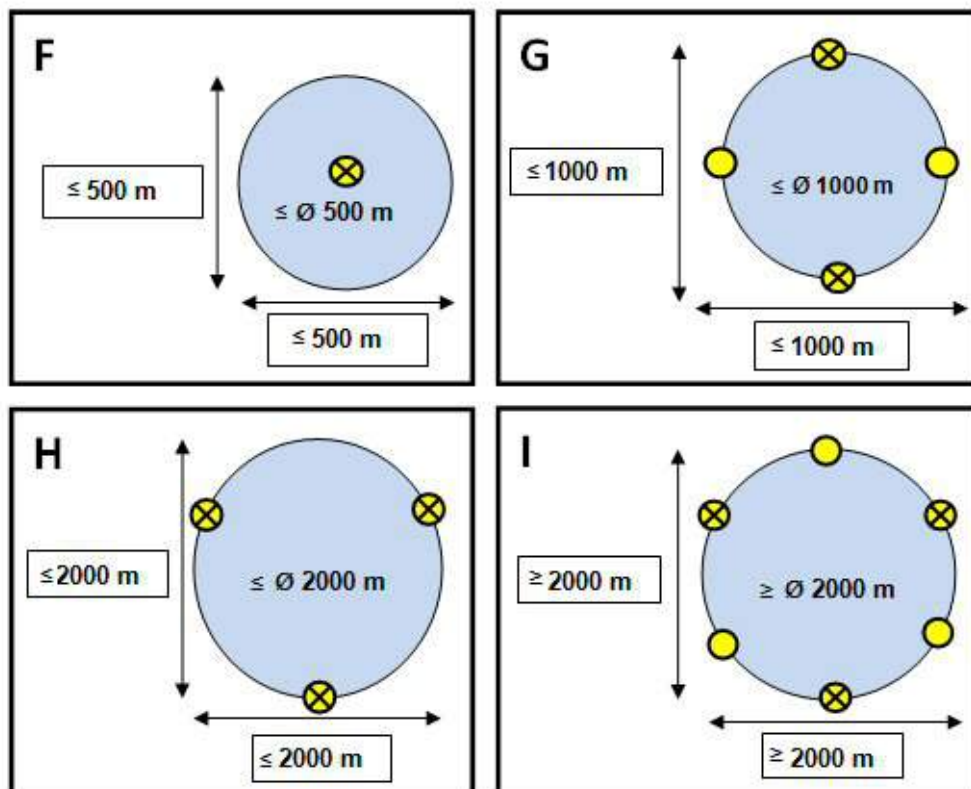

Figure 4 B. Circular Aquaculture Farms

### 3. FUTURE REQUIREMENTS

IALA is aware that there is an increasing quantity of energy devices and structures already in place and many more planned that may affect shipping.

It is therefore recommended that National Authorities continuously monitor developments to ensure that any navigational problems caused by offshore structures are solved in a satisfactory manner.

#### 4. DEFINITIONS AND ACRONYMS

**National Authority** - the competent Authority for determining the marking of offshore structures.

**Energy Extraction Device (EED)** - a wave or tidal generator.

**Highest Astronomical Tide (HAT)** - is the highest level that can be expected to occur under average meteorological conditions and under any combination of astronomical conditions. HAT is not an extreme level, as certain meteorological conditions can cause a higher water level.

**Nautical mile** – 1852m.

**Significant Peripheral Structure (SPS)** – the corner wind generator on a rectangular OWF or other significant point on the periphery of an OWF.

**Transformer Station (hub)** – a special structure within or outside the wave and/or tidal energy extraction field and/or OWF to which the individual generators are connected via a power cable. Power is transferred ashore from the transformer station by submarine cable. A 'hub' may be a separate fixed or floating platform, a unit very similar to the generators but carrying additional power conversion equipment.

**Usual Range** – the usual range of the fog signal shall be calculated in accordance with IALA Recommendation E-109, on the calculation of the range of a sound signal.

**Subsidiary Light** – additional red light(s) located on offshore platform(s) used to mark the extremities of extensive installations and their interconnecting bridges.

**Promulgation** – to make known by open declaration; publish; proclaim formally or put into operation (a law, decree of a court, etc.).

AIS	Automatic Identification System
AIS AtoN	AIS as an Aid to Navigation
AtoN	Aid(s) to Navigation
CALM	Catenary Anchor Leg Mooring
cd	Candela
FPSO	Floating Production Storage Offloading
HAT	Highest Astronomical Tide
IPS	Intermediate Peripheral Structure [OWF]
MBS	IALA Maritime Buoyage System
MER	Minimum Effective Range
MFP	Minimum Facilities Platform
MHWS	Mean High Water Springs
MSI	Maritime Safety Information (e.g. NAVTEX, Notices to Mariners)
OREI	Offshore Renewable Energy Installation
OWF	Offshore Wind Farm(s)
SOLAS	Safety of Life At Sea [convention].
SPM	Single Point Mooring
SPS	Significant Peripheral Structure [OWF]
UKC	Under Keel Clearance
WTG	Wind Turbine Generator

## APPENDIX 1 INVENTORY OF OFFSHORE STRUCTURES

This Appendix states definitions and gives examples of current offshore structures (in alphabetical order).

### 1. AQUACULTURE FARMS



*Figure 5 A fish farm*

Aquaculture is the cultivation of fresh-water and marine species, including fish, molluscs, crustaceans and aquatic plants. Unlike fishing, aquaculture, also known as aquafarming, implies the cultivation of aquatic populations under controlled conditions.

Particular kinds of aquaculture include algaculture (the production of kelp/seaweed and other algae); fish farming; shrimp farming, shellfish farming, and the growing of cultured pearls.

The worldwide practice of aquaculture ranges from low-technology extensive methods to highly intensive systems.

Aquaculture farms take on a variety of forms including huge tanks, freshwater ponds, and shallow- or deep-water marine environments. This document relates to farms in marine environments.

## 2. ARTICULATED LOADING PLATFORM (ALP) (OIL & GAS PERMANENT INSTALLATIONS)

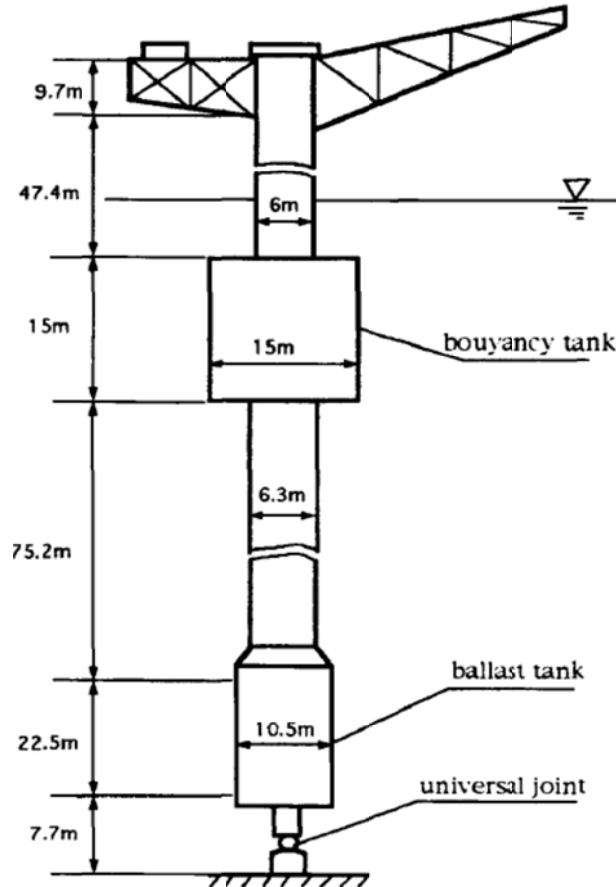

Figure 6 A diagram of an Articulated Platform

An ALP is a metal lattice tower, buoyant at one end and attached at the other by a universal joint to a concrete filled base on the sea bed. The platform may be fitted with a helicopter platform, emergency accommodation and hawser/hose retrieval.

### 3. CALM (OIL & GAS PERMANENT INSTALLATIONS - LOADING / DISCHARGE BUOYS)



*Figure 7 A Catenary Anchor Leg Mooring buoy*

CALM systems, are named so for the characteristic curve of the anchor legs that hold the buoy in position. These buoys are also often referred to as a single buoy mooring, monobuoy or loading buoy.

CALM buoys can be designed to berth any size tanker up to and including Ultra Large Crude Carriers (ULCCs).

The main applications of a CALM system are:

- Short term mooring: for import and export of fluids between onshore or offshore facilities and a tanker;
- Permanent mooring: for production and storage systems;
- Semi-permanent mooring: permanent mooring with easy disconnect capability to evacuate the facility in case of severe weather conditions.

#### 4. FLOATING PRODUCTION STORAGE OFFLOADER (FPSOS) (LOADING / DISCHARGE BUOYS)

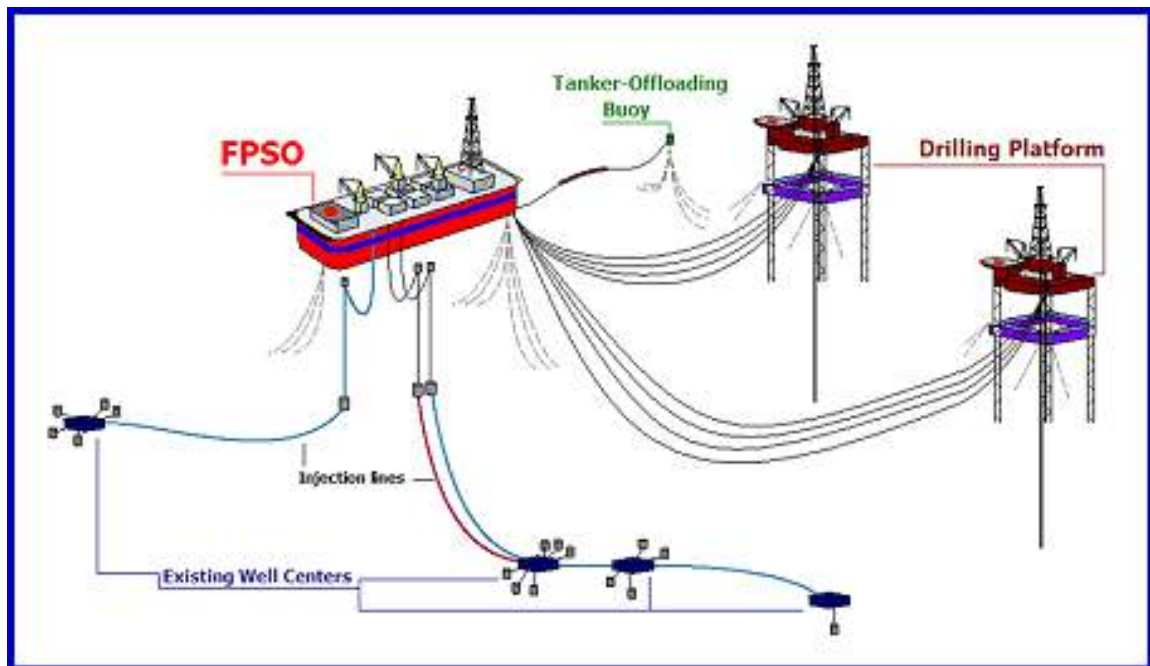

Figure 8 A Floating Production Storage Offloader

These are vessels which are usually self-powered and make their own way from the builder yard to the oil fields where they are permanently anchored, and act as floating tanks.

They may be purpose built or can be ships (VLCC, for example) that have passed their active trading life and were refitted into a FPSO.

#### 5. FLOATING WIND TURBINE



Figure 9 A floating wind turbine



A wind turbine that is moored to the seabed.

## 6. FLOTEL (OIL & GAS TEMPORARY STRUCTURES)



*Figure 10 An example of a Flotel*

This type of structure is a platform that is used as an R&R (rest and recuperation) location for workers; it is not an active rig.

## 7. LNG OFFLOADING POINTS

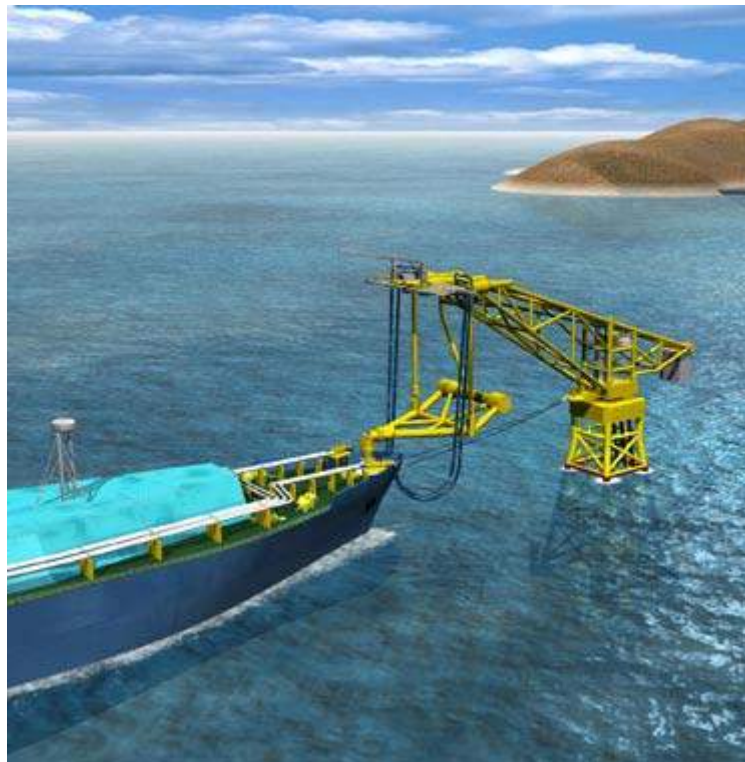

*Figure 11 An LNG Offloading Point*

These Offloading Points, which are used for loading / unloading LNG, are linked or fixed to the seabed and include many types of transference structures.

## 8. METEOROLOGICAL MASTS



*Figure 12 Meteorological Masts*

Any individual surface structure, usually consisting of an embedded mast or tower with meteorological measuring instruments.

## 9. MINIMUM FACILITY PLATFORM (MFP)



*Figure 13 An example of a Minimum Facility Platform*

These are unmanned platforms for a variety of purposes, such as pipeline booster stations and transformer stations.

## 10. OFFSHORE DOCKS / LOADING ISLANDS



*Figure 14 Offshore docks / Loading Islands*

Floating structures of various types and sizes, moored to the seabed and used for berthing and loading / unloading cargo.

## 11. PIPES

Underwater or subsea pipes are used worldwide. They are usually made of steel, have a concrete coating, and depending on the conditions, can be placed by barges with divers assistance.



*Figure 15 Typical underwater piping*

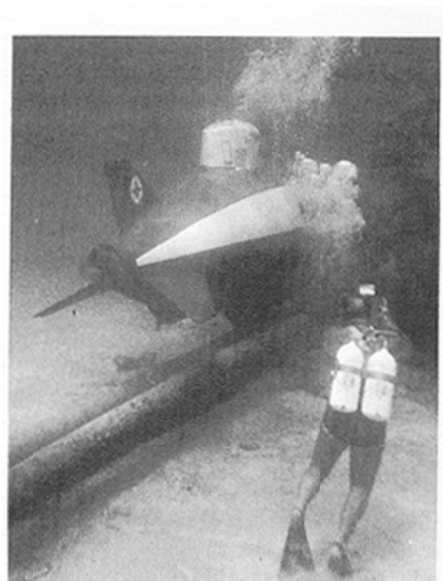

*Figure 16 Underwater pipe maintenance*

## 12. PRODUCTION PLATFORM / DRILLING RIGS



*Figure 17 An example of a Production Platform*

Production Platforms or Drilling Rigs are large structures used to house workers and machinery needed to drill and/or extract oil and natural gas through wells in the ocean bed. The platform may be attached to the ocean floor, consist of an artificial island, or be floating.

Many platforms also have remote wellheads attached by umbilical connections, these may be single wells or a manifold centre for multiple wells.

## 13. SEAPLANE BERTH



*Figure 18 An example of a Seaplane berth*

A Seaplane is a fixed-wing aircraft designed to take off and land on water. A seaplane berth is a structure that has berthing facilities for these kind of planes, which are generally used for connecting islands to the mainland.

#### 14. SEAWATER INTAKES / SEWAGE OUTFALLS



*Figure 19 A Seawater Intake / Sewage Outfall*

A seawater supply system can be found in many projects, and it includes Seawater Intakes and a discharge system. An outlet to a drainage network or a wastewater treatment is the Sewage Outfall.

#### 15. SINGLE POINT MOORING (SPM) (LOADING / DISCHARGE BUOYS)



*Figure 20 A Single Point Mooring buoy*

Loading Buoys are anchored offshore and serve as a mooring point for tankers to (off)load gas or fluid products. They are the link between the geostatic subsea manifold connections and the tanker.

The main purpose of the buoy is to transfer fluids between onshore or offshore facilities and the moored tanker.

These Buoys are generally referred to as Single Point Mooring systems or 'SPMs'. They are also often referred to as Single Buoy Moorings or 'SBMs'.

## 16. TENSION LEG PLATFORM (TLP) (OIL & GAS PERMANENT INSTALLATIONS)

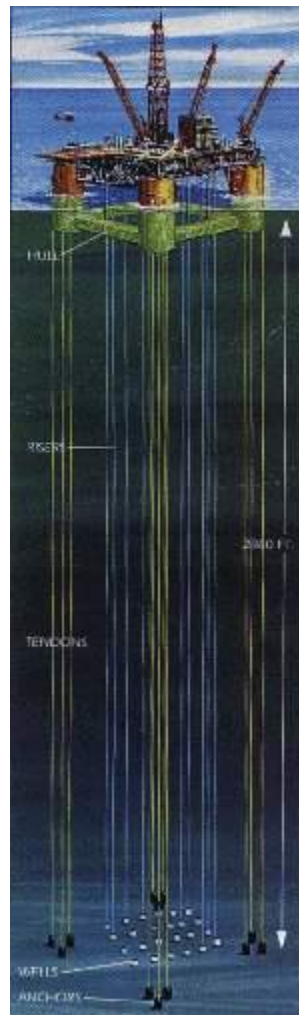

*Figure 21 A diagram of a Tension Leg Platform*

A Tension Leg Platform (TLP) is a buoyant platform held in place by a mooring system. The TLP's are similar to conventional fixed platforms except that the platform is maintained on location through the use of moorings held in tension by the buoyancy of the hull.

The topside facilities (processing facilities, pipelines, and surface trees) of the TLP and most of the daily operations are the same as for a conventional platform.

## 17. TIDAL GENERATOR



*Figure 22 Tidal Generators*

Any individual surface or sub-surface structure incorporating a generator, fixed or moored to the seabed and connected to an electrical terminal via cable(s).

## 18. TIDAL GENERATOR FIELD

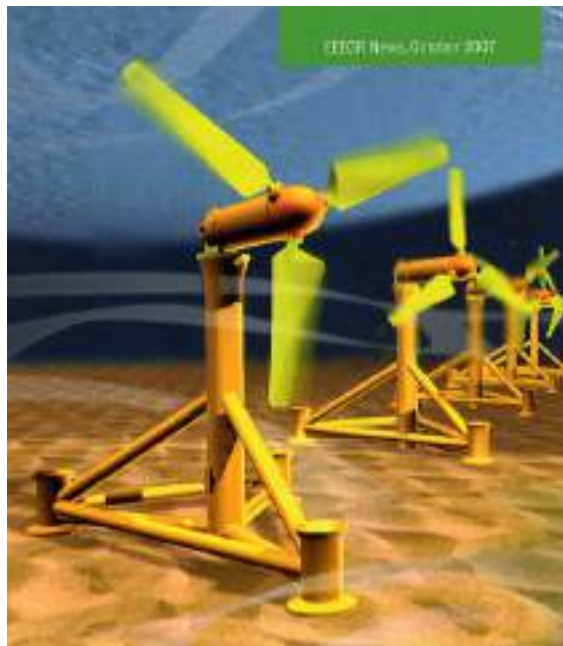

*Figure 23 A Tidal Generator Field*

A group of individual tidal generators, which are located in one block and are considered to be a unit, fixed or moored to the seabed and/or each other and connected to an electrical terminal via cable(s).

## 19. UNDERWATER MANIFOLDS / OBSTRUCTIONS



*Figure 24 An example of an underwater obstruction*

This group of structures comprises manifolds and various types of man-made obstructions placed on the seabed.

## 20. WATER INJECTION PLATFORMS OR BOOSTER STATION (WIPS)



*Figure 25 A Water Injection Platform*

Water injection platforms usually comprise a fixed steel platform, linked to a wellhead platform. The integrated topside has water injection facilities, water treatment facilities and power generation. This platform can also lodge a drilling rig.



## 21. WAVE GENERATOR

Production models will be coloured yellow, in accordance with the Recommendation.



*Figure 26 A Wave Generator*

Any individual surface or sub-surface structure incorporating a generator, moored to the seabed and connected to an electrical terminal.

## 22. WAVE GENERATOR FIELD

Production models will be coloured yellow, in accordance with the Recommendation.



*Figure 27 A Wave Generator Field*

A group of individual wave generators, which are located in one block and are considered to be a unit, moored to the seabed and/or each other and connected to electrical hub.

### 23. WIND GENERATOR



*Figure 28 A Wind Generator*

Any individual surface structure, usually consisting of an embedded mast or tower with rotating blades and incorporating a generator.

### 24. OFFSHORE WIND FARM



*Figure 29 An Offshore Wind Farm*

A group of individual wind generators, which are located in one block and are considered to be a unit.