

Capsizing of Roll-on/Roll-off
Vehicle Carrier *Golden Ray*
St. Simons Sound, Brunswick River,
near Brunswick, Georgia
September 8, 2019



Marine Accident Report

NTSB/MAR-21/03
PB2021-100930



**National
Transportation
Safety Board**

Marine Accident Report

Capsizing of Roll-on/Roll-off Vehicle Carrier *Golden Ray*
St. Simons Sound, Brunswick River,
near Brunswick, Georgia
September 8, 2019



**National
Transportation
Safety Board**

490 L'Enfant Plaza SW
Washington, DC 20594

National Transportation Safety Board. 2021. *Capsizing of Roll-on/Roll-off Vehicle Carrier Golden Ray, St. Simons Sound, Brunswick River, near Brunswick, Georgia, September 8, 2019. Marine Accident Report NTSB/MAR-21/03. Washington, DC: NTSB.*

Abstract: This report discusses the September 8, 2019, accident involving the roll-on/roll-off vehicle carrier *Golden Ray*, which capsized while transiting outbound through St. Simons Sound near Brunswick, Georgia. At the time of the accident, the vessel had 23 crew and 1 pilot on board; 2 crewmembers sustained serious injuries, and 4 engineering crew remained trapped in the engine room and engine control room for nearly 40 hours before being rescued. The vessel was declared a total loss. Total costs for the loss of the vessel were estimated at \$62.5 million, and total costs for the loss of the cargo were estimated at \$142 million. Safety issues identified in this report include improperly calculating vessel stability and lack of company oversight for calculating vessel stability. As part of its accident investigation, the National Transportation Safety Board makes two recommendations to G-Marine Service Co. Ltd.

The National Transportation Safety Board (NTSB) is an independent federal agency dedicated to promoting aviation, railroad, highway, marine, and pipeline safety. Established in 1967, the agency is mandated by Congress through the Independent Safety Board Act of 1974, to investigate transportation accidents, determine the probable causes of the accidents, issue safety recommendations, study transportation safety issues, and evaluate the safety effectiveness of government agencies involved in transportation. The NTSB makes public its actions and decisions through accident reports, safety studies, special investigation reports, safety recommendations, and statistical reviews.

The NTSB does not assign fault or blame for an accident or incident; rather, as specified by NTSB regulation, “accident/incident investigations are fact-finding proceedings with no formal issues and no adverse parties ... and are not conducted for the purpose of determining the rights or liabilities of any person” (Title 49 *Code of Federal Regulations* section 831.4). Assignment of fault or legal liability is not relevant to the NTSB’s statutory mission to improve transportation safety by investigating accidents and incidents and issuing safety recommendations. In addition, statutory language prohibits the admission into evidence or use of any part of an NTSB report related to an accident in a civil action for damages resulting from a matter mentioned in the report (Title 49 *United States Code* section 1154(b)).

For more detailed background information on this report, visit the [NTSB Case Analysis and Reporting Online \(CAROL\) website](#) and search for NTSB accident ID DCA19FM048. Recent publications are available in their entirety on the [NTSB website](#). Other information about available publications also may be obtained from the website or by contacting—

**National Transportation Safety Board
Records Management Division, CIO-40
490 L’Enfant Plaza, SW
Washington, DC 20594
(800) 877-6799 or (202) 314-6551**

Copies of NTSB publications may be downloaded at no cost from the National Technical Information Service, at the [National Technical Reports Library search page](#), using product number PB2021-100930. For additional assistance, contact—

**National Technical Information Service
5301 Shawnee Rd.
Alexandria, VA 22312
(800) 553-6847 or (703) 605-6000
[NTIS website](#)**

Contents

Contents	i
Figures and Tables	iii
Acronyms and Abbreviations	iv
Executive Summary	v
Accident	v
Probable Cause.....	v
Safety Issues.....	v
Findings.....	vi
Recommendations.....	vii
1. Factual Information	1
1.1 Accident Narrative	1
1.2 Emergency Response	6
1.2.1 Rescue of Trapped Crew.....	8
1.2.2 Injuries	9
1.3 Damage	10
1.4 Electronic Data Review	10
1.4.1 Stability Computer	10
1.4.2 Voyage Data Recorder	10
1.4.3 Integrated Monitoring, Alarm, and Control System	11
1.5 Vessel Information.....	11
1.5.1 Construction and Arrangement	11
1.5.2 Classification and Inspection	15
1.6 Personnel Information.....	16
1.6.1 Master	16
1.6.2 Chief Officer	16
1.6.3 Pilot.....	16
1.7 Operations	17
1.7.1 Safety Management System.....	17
1.7.2 Shipboard Training	18
1.7.3 Cargo Operations	18
1.8 Stability	21
1.8.1 International Code on Intact Stability, 2008 Requirements	21
1.8.2 NTSB Performance Study.....	22
1.8.3 Marine Safety Center Analysis	22
1.8.4 Additional Postaccident Analyses.....	26
1.8.5 Transportation Research Board.....	27
1.8.6 SOLAS Amendment	28
1.9 Waterway Information	28
1.9.1 General Information.....	28
1.9.2 Navigation Channel Surveys.....	28
1.10 Meteorological Information	29

1.11 Postaccident Actions	29
1.11.1 Coast Guard	29
1.11.2 Republic of the Marshall Islands	29
1.11.3 G-Marine Service Co. Ltd.....	30
2. Analysis	31
2.1 Introduction.....	31
2.2 Stability	33
2.2.1 Heeling Event.....	33
2.2.2 Vessel Stability and Loading Condition	34
2.2.3 Calculating Vessel Stability	34
2.3 Operator Oversight.....	36
2.3.1 Training.....	36
2.3.2 Audit Procedures.....	36
2.4 Flooding	38
3. Conclusions	40
3.1 Findings.....	40
3.2 Probable Cause.....	40
4. Recommendations	41
4.1 New Recommendations	41
5. Appendixes.....	42
Appendix A: Investigation.....	42
Appendix B: Consolidated Recommendation Information.....	43
Appendix C: Principles of Stability	44
Appendix D: Golden Ray Water Ballast Tanks	46
References	47

Figures and Tables

Figure 1. Roll-on/roll-off vehicle carrier <i>Golden Ray</i>	1
Figure 2. Trackline of the <i>Golden Ray</i> 's transit.....	3
Figure 3. The <i>Golden Ray</i> departing Jacksonville, Florida, on September 7	4
Figure 4. Aft-facing view of the bridge of the <i>Golden Ray</i>	6
Figure 5. Stern view of the grounded <i>Golden Ray</i> after the heeling event	7
Figure 6. Simplified diagram showing the engine room and engine control room exits.....	8
Figure 7. Rescue of trapped engineering personnel.....	9
Figure 8. Simplified profile of the <i>Golden Ray</i>	12
Figure 9. Simplified plan of water ballast tanks on <i>Golden Ray</i>	12
Figure 10. Watertight door indicator panel.....	13
Figure 11. Simplified overhead plan of the aft portion of deck 5.....	14
Figure 12. Simplified section view of the escape trunk and mid portside stairwell exit	15
Figure 13. Preload plan	19
Figure 14. Graphs from the <i>Golden Ray</i> performance study by the NTSB.....	22
Figure 15. Comparison of loading conditions.....	23
Figure 16. Righting arm curves generated by the MSC.....	24
Figure 17. Theoretical righting arm curves generated by the MSC.....	25
Figure 18. Righting arm curve calculated on the <i>Silver Ray</i> 's LOADCOM	27
Figure C-1. Forces that make a vessel stable or likely to capsize.	44
Figure D-1. IMACS water ballast system data	46
Table 1. Injuries sustained in the <i>Golden Ray</i> accident	10

Acronyms and Abbreviations

2008 IS Code	International Code on Intact Stability, 2008
GM	metacentric height
IMACS	Integrated Monitoring, Alarm, and Control System
IMO	International Maritime Organization
KG	vertical center of gravity
KMST	Korea Maritime Safety Tribunal
MSC	US Coast Guard Marine Safety Center
MT	metric tons
NOAA	National Oceanic and Atmospheric Administration
RMI	Republic of the Marshall Islands
Ro/Ro	roll-on/roll-off
SMS	safety management system
<i>SOLAS</i>	<i>International Convention for the Safety of Life at Sea</i>
T&S	Trim and Stability
TRB	Transportation Research Board
VDR	voyage data recorder

Executive Summary

Accident

About 0100 eastern daylight time on September 8, 2019, after unloading and loading vehicle cargo during the previous day, the 656-foot-long, Republic of the Marshall Islands-flagged roll-on/roll-off vehicle carrier *Golden Ray* departed the Colonel's Island Terminal in the Port of Brunswick, Georgia, en route to Baltimore, Maryland. A state pilot from the Port of Brunswick navigated the vessel as it proceeded outbound through the Brunswick River and into St. Simons Sound. The pilot navigated the vessel through two left turns, and, as the vessel approached the right turn into Plantation Creek Range, which led to the Atlantic Ocean, the pilot gave rudder orders to the helmsman to turn the vessel to starboard. As the vessel turned to starboard, it began to heel quickly to port.

The pilot and the vessel's master began rapidly issuing rudder commands in an attempt to counter the heeling. However, the *Golden Ray* continued to heel over, the rate of turn to starboard increased, and the vessel heeled to port to about 60° in less than a minute. Water entered deck 5 through the vessel's open portside pilot door and flooded through open watertight doors to the engine and steering gear rooms. The vessel eventually settled on its port side at an angle of 90°.

The US Coast Guard responded to the accident, along with tugboats and pilot boats from the Port of Brunswick, first responders from the Georgia Department of Natural Resources and Glynn County, and vessels from Sea Tow. Responders were initially able to rescue the pilot and 19 of the 23 crewmembers on board. Four engineering crewmembers remained trapped in the engine room until the following evening, September 9, when responders cut into the vessel's hull to rescue them. Two crewmembers suffered serious injuries. Total costs for the loss of the vessel were estimated at \$62.5 million, and total costs for the loss of the cargo were estimated at \$142 million.

Probable Cause

The National Transportation Safety Board determines that the probable cause of the capsizing of the *Golden Ray* was the chief officer's error entering ballast quantities into the stability calculation program, which led to his incorrect determination of the vessel's stability and resulted in the *Golden Ray* having an insufficient righting arm to counteract the forces developed during a turn while transiting outbound from the Port of Brunswick through St. Simons Sound. Contributing to the accident was G-Marine Service Co. Ltd.'s lack of effective procedures in their safety management system for verifying stability calculations.

Safety Issues

The safety issues identified in this accident include the following:

- [Improperly calculating vessel stability.](#) The operating company, G-Marine Service Co. Ltd., did not have stability software training for its officers who were responsible for using the *Golden Ray*'s LOADCOM stability calculation program. The company's safety management system outlined the chief officer's duties, including vessel stability

calculations, but did not provide any instructions on how to use or require competency for using the LOADCOM computer. Since the company did not provide training on how to use the computer, they had no means to ensure that the chief officer was capable of performing his duty to accurately determine the ship's stability. After the accident, G-Marine Service Co. Ltd. implemented several policies to improve safety and reduce the likelihood of another similar accident, including requiring stability calculation training for chief officers.

- **Lack of company oversight for calculating vessel stability.** The chief officer was the only crewmember responsible for calculating the stability of the vessel. Once the chief officer had calculated the vessel's stability, he reported the vessel's final metacentric height to the master and the company (via the departure report), but neither the master nor the company verified that the chief officer's calculations met stability requirements. The company had no procedures to verify stability calculations, so the master and company were unaware that the vessel had been sailing without meeting stability requirements during the accident voyage and two previous voyages, and there was no established means for the crew or the company to identify and attempt to correct the problem.

Findings

- None of the following safety issues were identified for the accident transit: (1) weather; (2) a transfer of ballast or fuel; (3) the propulsion and steering systems; (4) the shifting of cargo within the vessel; (5) obstructions in the channel that could have caused the vessel to ground; or (6) the cargo hold fire.
- The *Golden Ray* capsized because it did not possess enough righting energy to counter the port heeling moment created during the attempted execution of the 68° starboard turn at widener 11.
- At departure from the Colonel's Island Terminal, the *Golden Ray* did not meet international stability standards and possessed less stability than the chief officer calculated.
- The chief officer made errors with the ballast tank level data entry into the shipboard stability calculation computer (LOADCOM), which led to his incorrect determination of the vessel's stability.
- The operator did not have a method in place to ensure that the chief officer was proficient in using the shipboard stability calculation computer (LOADCOM) to perform his duty of calculating the ship's stability.
- The operator's lack of oversight and procedures for auditing and verifying the accuracy of their officers' vessel stability calculations before departure contributed to the *Golden Ray* not meeting international stability standards.
- After the *Golden Ray* heeled, open watertight doors on deck 5 allowed flooding into the vessel and blocked the primary egress from the engine room.

Recommendations

New Recommendations

As a result of its investigation of this accident, the National Transportation Safety Board makes the following two new safety recommendations:

To G-Marine Service Co. Ltd.:

[Revise your safety management system to establish procedures for verifying stability calculations and implement audit procedures to ensure your vessels meet stability requirements before leaving port. \(M-21-012\)](#)

[Revise your safety management system audit process to verify crew adherence to the Arrival/Departure Checklist regarding the closure of watertight doors. \(M-21-013\)](#)

1. Factual Information

1.1 Accident Narrative

On September 8, about 0137 eastern daylight time, the roll-on/roll-off (Ro/Ro) vehicle carrier *Golden Ray* capsized during a starboard turn while navigating the Port of Brunswick.¹ Of the 23 crew and 1 pilot on board, 2 sustained serious injuries; the remaining 22 were not injured. The *Golden Ray* and its cargo sustained significant damage due to fire, flooding, and saltwater corrosion.

On August 27, 2019, the Republic of the Marshall Islands (RMI)-flagged, 656-foot-long (200-meter-long) Ro/Ro *Golden Ray*, arrived in Freeport, Texas, to offload a portion of its cargo (vehicles) and load new cargo. The *Golden Ray* had a gross tonnage of 71,178 GT ITC, had a beam of 116 feet (35.4 meters), and could carry up to 7,742 vehicles (see figure 1).² The vessel had 23 crewmembers, including a master and a chief officer.



Source: US Coast Guard

Figure 1. Roll-on/roll-off vehicle carrier *Golden Ray* before the accident.

On August 28, a new master boarded the vessel and joined the crew, relieving the previous master. During the relief process, the two masters focused on the vessel's schedule, provisions on board, the condition of the vessel and cargo, and miscellaneous personnel issues. The new master

¹ For more information, see the factual information and analysis sections of this report. Additional information can be found in the public docket for this National Transportation Safety Board (NTSB) accident investigation (case number DCA19FM048) by accessing the [Accident Dockets link](https://www.nts.gov/Pages/default.aspx) at <https://www.nts.gov/Pages/default.aspx>. For information about our safety recommendations, see the [Safety Recommendation Database](#) at the same website.

² *GT ITC* refers to the gross tonnage measurement of the vessel under the Convention Measurement System as defined in the 1969 International Convention on Tonnage Measurements of Ships, which sought to unify the method by which ships were measured.

stated that the departing master did not report any issues with the vessel or crew during the relief process.

On August 30, the *Golden Ray* departed Freeport, Texas, en route to Brunswick, Georgia, after which the vessel was scheduled to proceed to Jacksonville, Florida, before heading to Baltimore, Maryland. However, shortly after departing Freeport, the vessel's charterer (Hyundai Glovis Co. Ltd.) notified the master that Hurricane Dorian was proceeding up the east coast of Florida. To enhance the stability of the vessel in anticipation of encountering the storm, the master had the chief officer load additional ballast (he did not specify how much additional ballast to load). The chief officer oversaw the loading of about 1,500 metric tons (MT) of sea water ballast into the vessel's three double bottom water ballast tanks (nos. 5 port, centerline, and starboard) and the no. 6 centerline water ballast tank (see [section 1.5.1, "Construction and Arrangement"](#) for a layout of the vessel's ballast tanks). The *Golden Ray* then waited off the coast of Key West, Florida, from September 1–3 to allow the hurricane to pass.

On September 3, the charterer directed the master to proceed to Jacksonville instead of Brunswick. Before entering the Port of Jacksonville, the ship's agent informed the chief officer that the port had draft restrictions. To reduce the *Golden Ray*'s draft to less than 9.4 meters (about 31 feet) as required by the port, the chief officer discharged about 1,500 MT of sea water ballast from the same tanks that were loaded on August 30 due to the hurricane.

Over the next few days, cargo was offloaded from and loaded onto the vessel at the Port of Jacksonville. On September 7, 2019, at 0510, the vessel departed the port, en route to Brunswick. The vessel was carrying 4,067 vehicles with a total cargo weight of 8,407.2 MT and was displacing 35,044 MT with a midship draft of 30.9 feet (9.4 meters).

The *Golden Ray* arrived outside the Port of Brunswick that afternoon, and, at 1453, a state pilot from the Brunswick Bar Pilots Association boarded the vessel to navigate the vessel into the port. The pilot and master conducted a master/pilot exchange to discuss the transit. After the exchange was completed, the pilot navigated the vessel to the Colonel's Island Terminal in Brunswick, docking at berth 1 at 1736. During the transit into the port, nothing unusual was noted by the pilot or crew.

After docking, shoreside personnel and the vessel's crew began cargo operations, offloading and loading vehicles through the stern ramp. The chief officer was responsible for ensuring that all vehicles were properly stowed and secured. There were no issues reported by shoreside personnel or the vessel's crewmembers with cargo unloading or loading.

Cargo operations were completed by 2330, and the chief officer supervised preparations for the vessel's departure. He stated that he transferred 8 MT of water from the no. 5 port double bottom water ballast tank to the no. 5 starboard double bottom water ballast tank, resulting in the vessel's list changing from 0.42° to port to 0.03° to starboard while at the dock.

About 0030 on September 8, the same pilot who navigated the *Golden Ray* into the Port of Brunswick boarded to pilot the vessel outbound from the port. During the master/pilot exchange, the pilot remarked that the draft of the vessel was the same as when the vessel entered the previous day (according to the pilot card, the draft was 30.8 feet [9.4 meters] forward and 31.2 feet aft [9.5 meters], which met the required minimum underkeel clearance of 3 feet in the 36-foot-deep channel). The vessel was displacing 34,609 MT, with a midship draft of 30.8 feet (9.4 meters).

About 0053, the pilot began issuing orders to take in the vessel's lines and maneuver the *Golden Ray* off the pier with undocking assistance from the tugboat *Dorothy Moran*. The pilot, as was typical for Port of Brunswick pilots, used a Portable Pilot Unit, which provided him with a navigation chart and an Automatic Identification System interface that displayed the headings, speeds, and rates of turn of the *Golden Ray* and other nearby vessels, as well as tidal and water depth information. After all lines were let go, the *Golden Ray* eased into the harbor with the *Dorothy Moran* pulling off the starboard quarter as the pilot issued rudder and engine commands to begin the transit through the channel and out to the sea buoy.

At 0055, the pilot ordered slow ahead. About two minutes later, at 0057:11, the pilot ordered half ahead, and by 0100, the *Golden Ray* was proceeding outbound in the Turtle River Lower Range at 6 knots on a course of 113°. (Figure 2 shows the vessel's transit as it exited the Port of Brunswick.) At 0102:43, the pilot ordered full ahead. The *Dorothy Moran* cast off its line but remained with the *Golden Ray* to provide support as needed. As the vessel transited the channel over the next few minutes, nothing unusual was noted by the pilot or crew of the *Golden Ray* or by the master of the *Dorothy Moran*.



Background source: Google Earth

Figure 2. Trackline of the *Golden Ray*'s transit after it departed the Colonel's Island Terminal.

While the *Golden Ray* was proceeding outbound, the vehicle carrier *Emerald Ace* was proceeding inbound with another Port of Brunswick pilot conning the vessel. The two pilots on board these ships were in communication with each other via radio and had arranged for the vessels

to meet in the Plantation Creek Range of St. Simons Sound, which was common practice for the pilots, since it was the widest area of the waterway for vessels to pass each other.³

About 0108, the vessel passed under the Sydney Lanier Bridge, where the *Dorothy Moran* stopped its transit with the *Golden Ray* and awaited the inbound *Emerald Ace* to escort it and assist it with docking. The *Golden Ray* proceeded outbound in the Brunswick Point Cut Range on a course of 113°, following pilot orders.

About the same time, the master ordered the crew to open the portside pilot door (side port), located on deck 5, in preparation for the pilot's planned departure just outside of the Port of Brunswick at the sea buoy (see figure 3). The pilot door was a watertight hatch in the side shell that opened and closed locally by an electronic/hydraulic system; the door was 7 feet (2.1 meters) high and 7 feet (2.1 meters) wide. After supervising the opening of the portside pilot door, the chief officer went to his stateroom. The crewmembers left to conduct other duties, and no one remained at the open door as the vessel proceeded outbound.



Source: Coast Guard

Figure 3. The *Golden Ray* departing Jacksonville, Florida, about 0130 on September 7. The light amidship is the open portside pilot door. (The lights on the blue hull at the bow and stern are mooring line stations.)

At 0122:43, the vessel approached the Cedar Hammock Range at a speed of 11.6 knots. The pilot ordered 20° port rudder to turn left into the Cedar Hammock Range at a course of 075° (a change in course of 38°).

From this turn, it was 1.3 nautical miles (1.15 statute miles) to the next left turn into the Jekyll Island Range.⁴ At 0128:50, at a speed of 12.1 knots, the pilot again ordered 20° port rudder

³ St. Simons Sound was located halfway between the commercial vessel docks at the Colonel's Island Terminal and the limits of the port and provided a 1,000-foot-wide area with a water depth greater than regulated depth. It was general practice for local pilots to use this area of St. Simons Sound for passing when there was an outbound vessel departing and an inbound vessel entering the port. This part of the waterway provided pilots with more area for the vessels to safely meet, and, if something went wrong to prevent a safe passage, such as a propulsion failure, there was space to anchor a vessel.

⁴ Unless otherwise noted, all miles in this report are statute miles.

to enter the range at a course of 037° (a change in course of 38°). The vessel made both left turns without incident.

At 0134:53, at a speed of 12.4 knots and a heading of 039°, the *Golden Ray* approached the 68° right turn at widener 11.⁵ The pilot ordered a heading of 044°. About one minute later, at 0136:08, the pilot ordered “starboard 10” to initiate the turn. At 0136:15, with the vessel’s speed at 12.9 knots, the helmsman informed the pilot that the rudder was at starboard 10. Shortly after, at 0136:39, the pilot ordered “starboard 20” to enter the Plantation Creek Range, which had a course of 105° and led to the Atlantic Ocean. The helmsman moved the rudder to comply with the pilot’s command; the vessel’s speed at the time was 13.3 knots.

Seconds later, at 0136:47, the pilot ordered the rudder returned to midships (zero rudder angle). The helmsman complied with the pilot’s order, and, according to the pilot, the “ship just took off.” At 0136:58, the vessel started to heel to port. The pilot stated that as the vessel began to turn, it “felt directionally unstable...meaning when I started the turn, she wanted to keep turning.” Crewmembers on the bridge could be heard on the voyage data recorder (VDR) expressing surprise, and the pilot asked, “what’s the GM [metacentric height] on this thing?”⁶

The pilot issued a “port 10” order to counter the heel and the increasingly sharp turn to starboard. The pilot and master began swiftly issuing additional rudder commands to the helmsman to attempt to counter the heeling. However, the *Golden Ray* continued to rapidly heel to port, and its rate of turn to starboard increased. Additionally, equipment began shifting on the bridge, and numerous alarms began to sound.

Between 0138 and 0139, the pilot issued orders to turn on the vessel’s bow thruster and put the engine in reverse in an attempt to stop the vessel from heeling over. The vessel’s heading at the time was 135°, and its speed was 5.3 knots.

At 0140:18, the *Golden Ray* stopped and grounded outside of the channel, southeast of buoy 19, with a 60° list to port (see figure 4). The main propulsion system and electrical generating systems shut down just prior to the vessel grounding. The emergency diesel generator initially started following the loss of power, but shut down within a few minutes, leaving the vessel with no electrical power or lighting as the pilot and crew evaluated the situation and began to respond. The portside pilot door remained open, and flooding began through the door into deck 5.

⁵ According to the US Army Corps of Engineers, a *widener* is located on a turn or bend of a channel to provide a vessel with additional width to allow for easier navigation as the vessel turns.

⁶ *Metacentric height* (GM) refers to the distance from the ship’s center of gravity to its metacenter and measures the vessel’s ability to right itself when experiencing an overturning moment. (See [Appendix C](#) for principles of stability.)

The pilot contacted the pilot on board the *Emerald Ace* to inform him that the *Golden Ray* had heeled over and the crew needed to be evacuated from the vessel. Fearing that the vessel would “sink in the deep channel,” he also called the *Dorothy Moran* over very high frequency radio to request additional tugs from Moran Towing (owner of the *Dorothy Moran* and other tugboats in the Port of Brunswick) be sent from the port. The pilot next hailed US Coast Guard Sector Charleston on his handheld radio to report the incident and request assistance. The *Emerald Ace* pilot called 911 emergency services to report the incident.

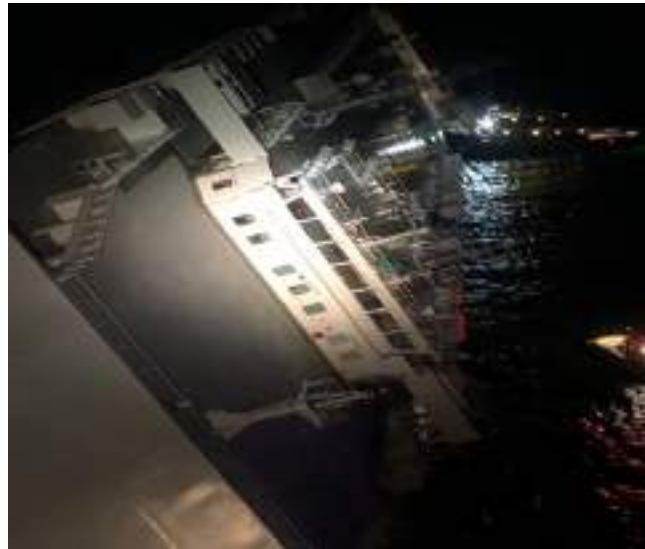

Source: Coast Guard

1.2 Emergency Response

Shortly after the pilot reported the accident, pilot boats from the port and two tugs (the *Dorothy Moran* and the *Ann Moran*) from Moran Towing began responding to the scene. The tugs were used to stabilize the *Golden Ray* by pushing it into the bank to prevent it from sliding and sinking into the deeper water while the pilot boats assessed the situation and reported back to the *Golden Ray*'s pilot.

Figure 4. Aft-facing view of the bridge of the *Golden Ray* with a 60° list on September 8, 2019, following the accident.

About 0154, about 10 minutes after being informed of the *Golden Ray*'s distress by 911 dispatch, Coast Guard Boat Station Brunswick launched its 45-foot response boat (*CG 45741*). Along with the Coast Guard response boat, a Coast Guard helicopter (an MH-65 Dolphin) was launched, and first responders from the Georgia Department of Natural Resources and Glynn County and vessels from Sea Tow were dispatched to assist.

First responders began arriving on scene about 0205. The crew of the *CG 45741* were able to communicate with the pilot on board the *Golden Ray* via a pilot boat that was in radio contact with him, and the pilot confirmed that there were 24 persons on board the vessel. Over the next hour, 11 crewmembers were lowered down to the *CG 45741* from the bridge of the *Golden Ray* via a fire hose, including the pilot and the master, who informed responders that 4 engineering personnel were still in the engine room.

Five other crewmembers were rescued by other responders while the Coast Guard helicopter hoisted two crewmembers from the starboard side of the vessel. At 0300, another response boat (*CG 29139*) from Coast Guard Station Brunswick arrived on scene to assist with the search and rescue of the *Golden Ray*'s crew. At 0344, the *CG 45741* transferred the personnel they had rescued to the *CG 29139* for transport back to the station, and the *CG 45741* continued to search for the remaining crew.

About 0430, first responders noticed smoke and flames on the starboard side of the *Golden Ray* in the area of the vehicle decks (see figure 5). The cargo hold contained combustible materials, including tires and plastic components in the vehicles. Because of the reported thick, black smoke

and heat, responders could not enter the vessel to search for the missing engineers. The fire lasted about 24 hours before burning itself out.



Source: Coast Guard

Figure 5. Stern view of the grounded *Golden Ray* after the heeling event. Flame and smoke emanate from the starboard side in the area of the cargo decks. Photo taken 6 hours after the heeling event.

At 0645, the crew of the *CG 45741* rescued two more crewmembers, including the chief engineer, who was trapped in his cabin (located below the port bridge wing), by breaking the cabin's window so that he could be pulled out.

With the channel's soft bottom and water flooding through the open portside pilot door, the hull continued to shift. About 0930, as the vessel slowly rolled farther onto its port side to a 90° angle just outside the channel, first responders heard loud crashing sounds from inside the *Golden Ray*.

The pilot and 19 rescued crewmembers were brought on board the *CG 29139* and transported to Coast Guard Station Brunswick, where they were treated by emergency medical services before being transferred to a local hospital. Since there were still four crewmembers (three engineers and a cadet) who had yet to be rescued, first responders continued to monitor the vessel for signs that the remaining crewmembers were alive.

1.2.1 Rescue of Trapped Crew

At the time of the heeling, one engineer and an engineering cadet had been conducting a round of the engine room, while two other engineers were in the engine control room on deck 4. After the vessel capsized, the two engineers in the engine control room attempted to leave through

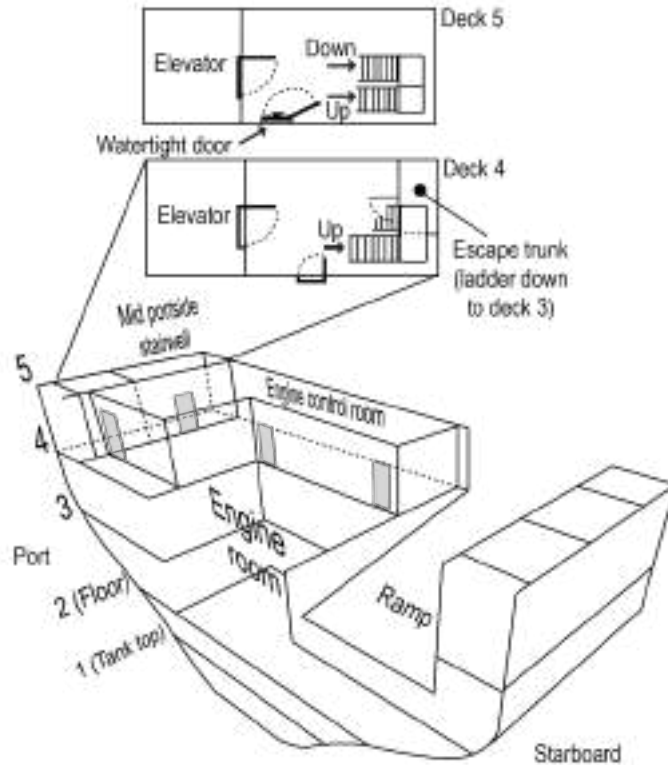

Figure 6. Simplified diagram showing a portion of the engine room and engine control room exits. Doors shaded gray.

the mid-portside stairwell—the primary stairwell serving the engine control room and engine room—but were blocked by incoming water, which was entering the stairwell from an open watertight door on deck 5. The engine control room also had three other doors facing aft that accessed the engine room directly (see figure 6).

Over the next 2–3 hours, water flooded the stairwell and began to enter the engine control room. One of the engineers was able to exit the engine control room through an aft-facing door about 12 feet (3.7 meters) to the port side of the vessel's centerline (middle aft-facing door) and joined the other engineer and engineering cadet in the engine room before the incoming flood water completely covered the aft-facing door; the fourth engineer remained in the engine control room. No main or emergency lighting illuminated the engine room, leaving it completely dark, though the engineering cadet did have a flashlight. The engineers later stated that their means of escape were blocked by the flood water, and as the vessel had settled and its port list slowly increased, the water level

within the engine room had risen. The rising water, accumulating on the port side and contaminated with oil, led the engineers to move up higher (toward the ship's starboard side). As time went by, the air temperature within the engine room rose. According to the engineers, the excessive heat made it very uncomfortable and hard for them to breathe, and they eventually entered the flood water to stay cool.

Just over 16 hours after the accident, at 1812 on September 8, first responders reported hearing tapping noises from within the vessel. The following day, the Coast Guard, working closely with Donjon-SMIT and Defiant Marine (both salvage and first responder companies), and Elevated Safety (who were experts in confined-space rescues), as well as Glynn County Heavy Rescue-8 and the Georgia Department of Natural Resources, developed what they determined to be the safest plan to rescue the engineers, which included procuring cold cutting equipment to safely create an escape access into the hull. It was expected to take about 14 hours to get the equipment on site. About 1300, responders drilled a 2.5-inch hole through the hull and made

contact with the engineers (see figure 7). An atmosphere reading of the engine room showed its temperature was as high as 155°F. Realizing that the internal atmosphere was extremely hazardous to the engineers, the rescuers continued drilling holes to create a square access opening into the hull rather than wait for the requested cold cutting equipment to arrive.



Source: Coast Guard

Figure 7. Emergency responders attempt to rescue the trapped engineers and cadet (left). Responders drilled holes into the hull to access the engineers (right).

The two engineers and cadet who were trapped in the main engine room space were rescued at 1500. Rescuers had to breach the explosion-proof glass of the engine control room to reach the fourth engineer, and, at 1751, he exited the vessel. All of the engineering crew were in good condition.

At 1800, a second fire was reported within the vehicle decks. This fire burned itself out the same night.

1.2.2 Injuries

As a result of the accident, two crewmembers suffered serious injuries. The third mate had a laceration on her right hand and a joint fracture of her right middle finger, and the bosun's left foot was fractured. Both crewmembers were medically evaluated at Coast Guard Station Brunswick and transported to a local hospital, where they were treated for their injuries.

Table 1. Injuries sustained in the *Golden Ray* accident.⁷

Type of Injury	Crew (23 crew, 1 pilot)
<i>Fatal</i>	0
<i>Serious</i>	2
<i>Minor</i>	0
<i>None</i>	22

1.3 Damage

The *Golden Ray* sustained significant damage due to fire damage, flooding, and saltwater corrosion. The vessel was declared a total loss estimated at \$62.5 million. The vehicle cargo loss was estimated at \$142 million.

Efforts to salvage the wreck of the *Golden Ray* began on November 9, 2020. As of the publication of this report, salvage and removal of the wreck has not been completed, but salvage costs were last estimated to be in excess of \$250 million.

1.4 Electronic Data Review

1.4.1 Stability Computer

After the accident, the *Golden Ray*'s stability calculation computer, LOADCOM (manufactured by Totem Plus, Ltd.), was removed. However, the unit sustained extensive saltwater damage, and investigators therefore could not retrieve the vessel loading condition data entered by the chief officer. (More details about the LOADCOM computer can be found in [section 1.7.3, "Cargo Operations."](#))

1.4.2 Voyage Data Recorder

The *Golden Ray* was equipped with a VDR manufactured by Totem Plus, Ltd. The VDR was recovered after the accident, and its data, including parametric data from the accident voyage on September 8 and the previous voyage into Brunswick, Georgia, on September 7, were sent to the National Transportation Safety Board (NTSB) for review. There were, however, several recording gaps in the data from the previous voyage.

The parametric and audio data on the VDR for the accident voyage contained the sequence of events as the *Golden Ray* approached the right turn at widener 11, including the vessel's heading and speed throughout the transit, as well as the pilot's orders to the bridge crew. A review of the recorded bridge audio showed that before the heeling event, there was no indication from the pilot

⁷ The NTSB uses the International Civil Aviation Organization injury criteria in all of its accident reports, regardless of transportation mode. A serious injury is a non-fatal injury that requires hospitalization for more than 48 hours, commencing within 7 days from the date the injury was received; results in a fracture of any bone; causes severe hemorrhages, nerve, muscle, or tendon damage; involves any internal organ; or involves second- or third-degree burns, or any burn affecting more than 5 percent of the body surface.

and crewmembers on the bridge that there were any concerns with the vessel. In addition, there were no alarms heard sounding on the bridge until after the vessel began to heel to port at approximately 0137.

1.4.3 Integrated Monitoring, Alarm, and Control System

Data was recovered from the vessel's Integrated Monitoring, Alarm, and Control System (IMACS), a system also manufactured by Totem Plus, Ltd. that provided the ability to visualize the vessel's power management system, tank-level indications, anti-heeling and loading programs, and the engine monitoring and automation features, and recorded many of these associated parameters so that the crew could review past operations. The system's data were extracted by the manufacturer, and the NTSB reviewed the data, particularly the vessel's list as recorded by the system's inclinometer. The IMACS data showed that, after the vessel departed its berth at the Colonel's Island Terminal, there were no changes to the vessel's monitored systems before the vessel heeled.

The IMACS data also showed that on September 8, when the *Golden Ray* was docked and preparing to begin its outbound transit from the Port of Brunswick, the vessel contained a total of 4,600 MT of liquids on board, including 2,981.45 MT of ballast. The vessel also contained 891.38 MT of heavy fuel, 321.91 MT of diesel fuel, and 46.29 MT of miscellaneous liquids, as well as 360 MT of liquid loads not recorded by IMACS ([see Appendix D](#)).

1.5 Vessel Information

The *Golden Ray* was built in 2017 at the Hyundai MIPO Dockyard in Ulsan, South Korea. The vessel was owned by GL NV24 Shipping Inc. and operated by G-Marine Service Co. Ltd., a South Korean shipping management company established in 2006. The company's fleet was comprised of 51 vessels, including a vessel of the same class, the *Silver Ray*. On both the *Golden Ray* and the *Silver Ray*, G-Marine Service Co. Ltd. (the operator) was responsible for crewing and managing the vessels.

After the *Golden Ray* and *Silver Ray* were completed in 2017, both vessels were chartered by Hyundai Glovis Co. Ltd., a logistics company founded in 2001 and headquartered in South Korea. On both the *Golden Ray* and the *Silver Ray*, Hyundai Glovis Co. Ltd. (the charterer) was responsible for organizing cargo operations.

1.5.1 Construction and Arrangement

The *Golden Ray* was constructed of steel and had 15 decks, including the cargo decks, bridge, and accommodations (see figure 8). Of the 12 enclosed decks that housed vehicle cargo, 8 were fixed, and 4 were adjustable and could be raised or lowered to accommodate cargo of various sizes. Deck 5 was the vessel's watertight freeboard (or bulkhead) deck.⁸ The ship had two loading

⁸ The terms *freeboard* and *bulkhead deck* are used interchangeably. The bulkhead deck is the highest deck to which the transverse watertight bulkheads and shell are carried. The freeboard deck is normally the uppermost continuous deck exposed to the weather and the sea. It has permanent means of closing all openings weathertight (meaning that in any sea conditions, water will not penetrate). Below the freeboard deck, all openings in the sides of the ship are fitted with permanent watertight closings.

ramps on deck 5: one aft on its starboard stern quarter and another on the starboard side. Fore and aft mooring stations were on deck 7, which was a watertight deck. Deck 13 was also called the upper deck, or weather deck. The vessel had one aft stairwell from deck 4 to deck 13; two mid stairwells (port and starboard) from deck 4 to deck 13; and one forward stairwell from deck 7 to deck 13.

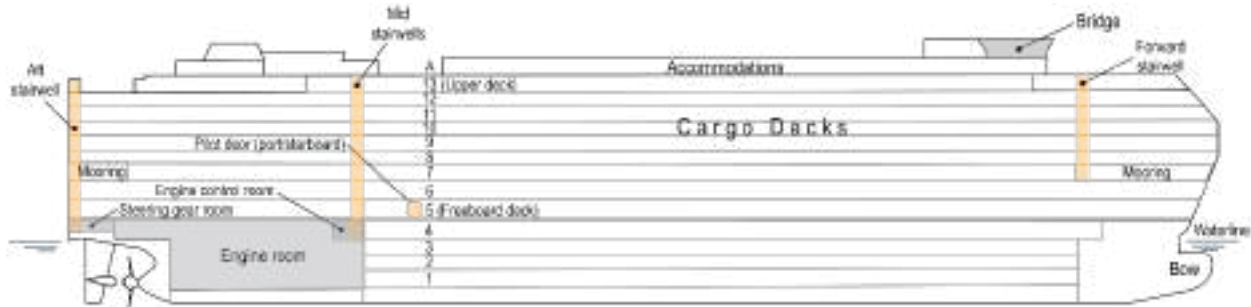

Background source: General arrangement drawing, Hyundai MIPO Dockyard

Figure 8. Simplified profile of the *Golden Ray*.

The vessel had 22 ballast tanks, comprised of 18 water ballast tanks, a fore peak tank, and 3 aft peak tanks (see figure 9). The total volume of the tanks was 9,842 cubic meters, and, when the tanks were completely full of salt water, the total capacity was 10,088 MT. Three water ballast tanks did not extend above the lowest cargo deck (deck 1) and were designated double bottom tanks (no. 5 starboard, centerline, and port water ballast tanks). (See [Appendix D](#) for water ballast tank levels at the time of the accident.)

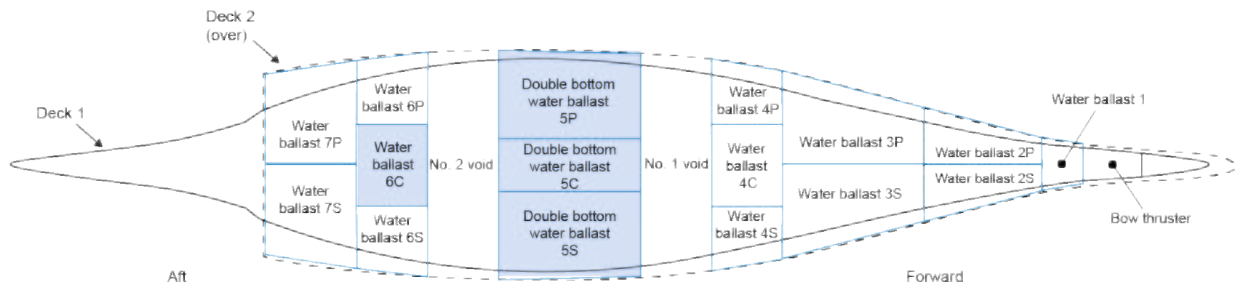

Background source: General arrangement drawing, Hyundai MIPO Dockyard

Figure 9. Simplified plan of water ballast tanks on *Golden Ray*. Blue lines show water ballast tanks, and blue highlights show water ballast tanks used to transfer ballast prior to the accident voyage. Note: the solid line is deck 1, and the dashed line shows deck 2 above. Fore and aft peak tanks are not indicated for clarity.

Watertight Doors. In addition to the pilot door, stern ramp, side ramp, and four ramp covers, the *Golden Ray* had 17 watertight doors and 13 watertight hatches that, when shut, maintained the vessel’s watertight integrity. On the vessel’s bridge, there was a watertight door indicator panel that showed whether the watertight doors and hatches were open (red light) or closed (green light) (see figure 10).



Source: Coast Guard

Figure 10. Watertight door indicator panel located on the bridge of the *Silver Ray*, a vessel of the same class as the *Golden Ray*.

The IMACS data showed that in addition to the portside pilot door, the watertight doors to both the aft and mid portside deck 5 stairwells were open at the time of the accident and had been open since 2341 on September 7 before the vessel departed the Colonel's Island Terminal. The mid portside stairwell, about 75 feet (22.9 feet) aft of the pilot door, served as the primary access to the engine room and the engine control room on deck 4; the escape trunk stairwell serving the lower engine room exited to this stairwell at deck 4 (see figure 11).

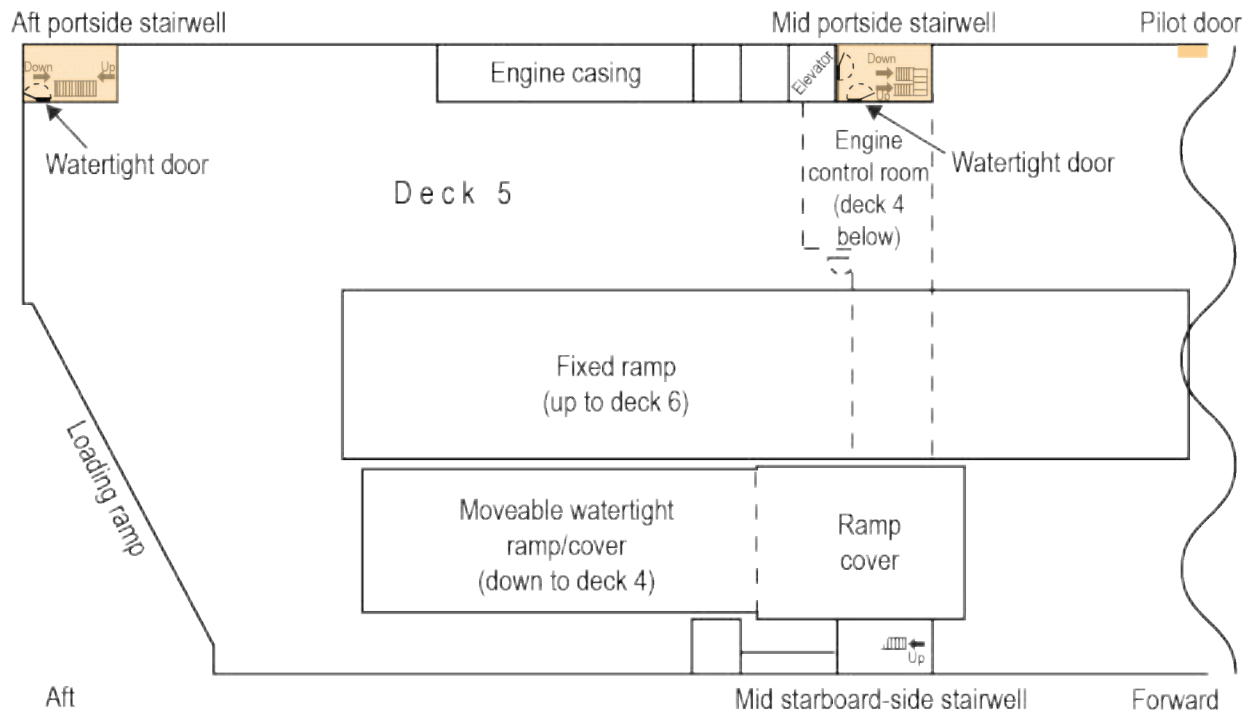

Background source: Hyundai MIPO Dockyard

Figure 11. Simplified overhead plan of the aft portion of deck 5. The stairwells with open watertight doors and the pilot door are highlighted. Dashed lines indicate spaces on deck 4 below.

The aft portside stairwell at the stern served as access to the steering gear room on deck 4 (the engine room and steering gear room were separated by a watertight transverse bulkhead and connected to each other on deck 4 by a watertight door). Both the aft and mid stairwells were “towers”—isolated spaces with fire-protected bulkheads that ran vertically up to deck 13, with doors serving car decks in between (see figure 12). On deck 13, the upper deck, the doors allowed exit to the weather deck (outside). There was also an exit from the engine room on the port side from deck 4 by a series of vertical ladders that led up through the engine casing to the upper deck.

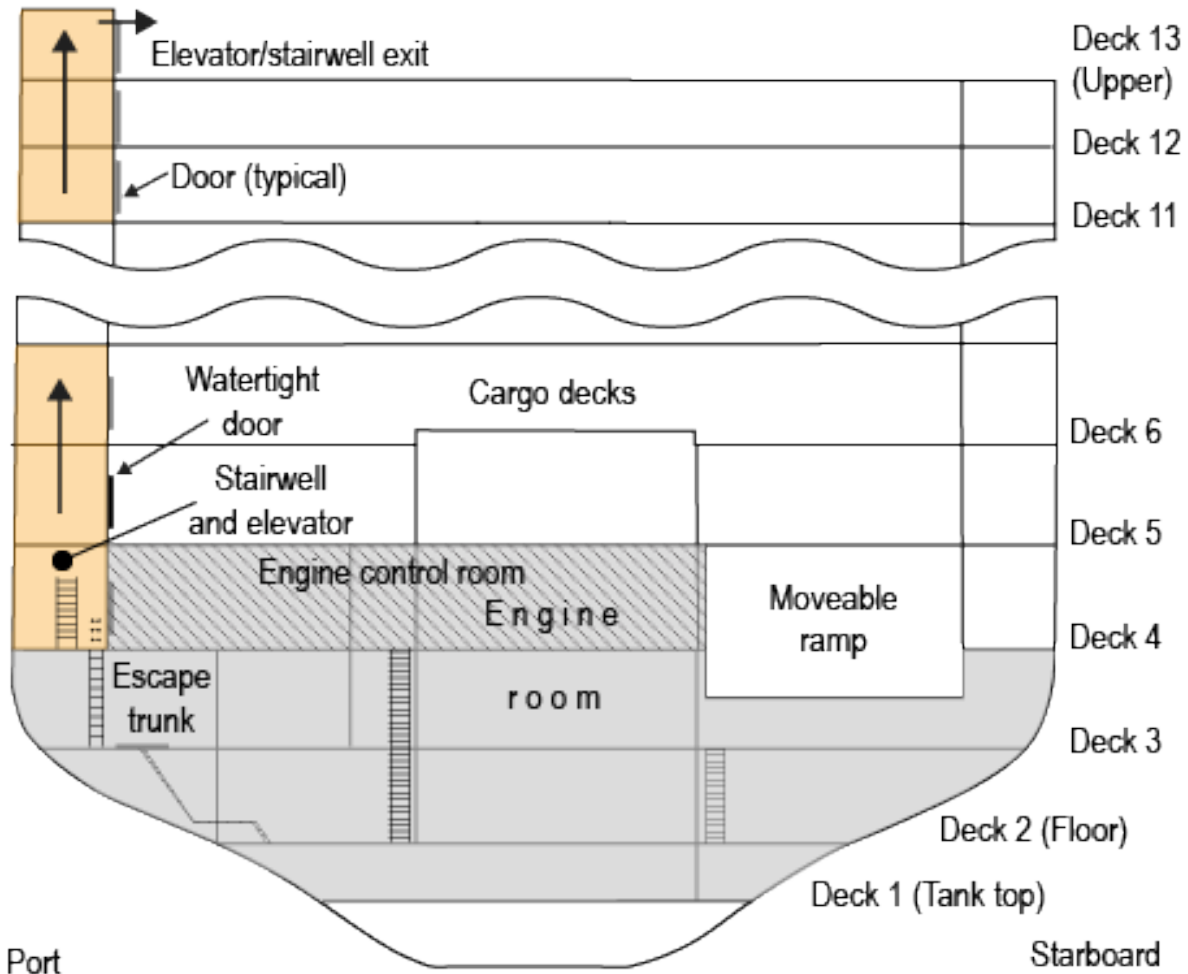

Figure 12. Simplified section view of the escape trunk and mid portside stairwell exit from the engine room and engine control room.

1.5.2 Classification and Inspection

The *Golden Ray* was classed by the Korean Register of Shipping and had received its certificate of classification in December 2017. The vessel also held valid *International Convention for the Safety of Life at Sea (SOLAS)* certificates for safety, communications, machinery, and other equipment issued by the Korean Register of Shipping. There were no conditions of class (deficiencies with the structure or maintenance of the vessel that required correction) issued against the vessel before the accident.

At the time of the accident, the vessel's Certificate of Registry, which had been issued by the RMI in November 2018, was valid. Additionally, the *Golden Ray* had a valid Safety Management Certificate issued under the authority of the Government of the RMI by the Korean Register of Shipping, certifying that the vessel complied with the requirement of the International Management Code for the Safe Operations of Ships. The certificate was issued on July 23, 2018, based on an audit completed on May 4, 2018, and would have remained valid until May 23, 2023.

The *Golden Ray* underwent ten Port State Control Examinations from 2017 to 2019, including two by the Coast Guard when the vessel was in US ports, to ensure the vessel complied with International Maritime Organization (IMO) requirements. The Coast Guard also ensured compliance with applicable US regulations. No significant deficiencies were documented during the Port State Control Examinations.

1.6 Personnel Information

The *Golden Ray* had a crew of 23, all of whom were properly credentialed and possessed the appropriate flag-state endorsements for their positions on board the vessel. The vessel was crewed in compliance with the Minimum Safe Manning Certificate issued by the RMI.

1.6.1 Master

The master, who held overall command of the vessel, joined the crew of the *Golden Ray* on August 28, 2019, 11 days before the accident, while the vessel was docked in Freeport, Texas. He had been sailing since 1980, and he became a captain in 1995. He had been working on vehicle carrier vessels since 2016 and had begun working for the operator in 2017. The master had not sailed on the *Golden Ray* or the *Silver Ray* before.

1.6.2 Chief Officer

The chief officer, who was second in command of the vessel, was a credentialed deck officer who had joined the crew of the *Golden Ray* in Gwangyang, Republic of Korea, on March 5, 2019 (about 6 months before the accident). He had been sailing for about 13 years and had been a chief officer for 10 years, 6 of which were on a vehicle carrier.

1.6.3 Pilot

The pilot on board the *Golden Ray* during the accident was one of six Port of Brunswick Bar Pilots who navigated vessels as they transited within the port. The pilot had been working in the maritime industry since 1997. He held a Coast Guard first class pilot endorsement for the Port of Brunswick and had held a state license since 2000. Additionally, he had held an unlimited restriction pilot's credential from the state of Georgia since January 2014. He stated that "probably 95 percent or more of our cargo—our ships calling here are roll-on/roll-off ships."

The Port of Brunswick pilot rotation was 24 hours long and was arranged so that the same pilot who guided a vessel into the port would guide it out of the port after cargo operations were completed. The accident pilot stated that this procedure enhanced crew-pilot familiarization and reduced the logistical demand for the pilots to arrange multiple means of transportation when a pilot was finished.

All the pilots in Brunswick were self-employed and were associated together to collectively manage the pilot operation for the port's commercial vessel traffic. Each pilot was required to hold a Coast Guard first class pilot endorsement and a Georgia State Pilot credential and to successfully complete a three-year apprenticeship under the supervision of senior pilots. Once the apprenticeship was successfully completed, the Georgia commissioner of pilotage issued the pilot a credential for smaller vessels (no longer than 525 feet [160 meters] and no more than 25 feet

[7.6 meters] of draft). The training continued as a pilot qualified for credentials for progressively larger vessels until they obtained an unlimited restriction state pilot's credential.

1.7 Operations

1.7.1 Safety Management System

A safety management system (SMS) is a structured and documented system designed to enable company personnel to effectively implement the company's safety and environmental protection policy, as well as the *International Safety Management Code*.⁹ Regardless of the size of the company, an SMS ensures standardized procedures for each crewmember during both routine and emergency operations. Safety of operations and compliance with mandatory rules and regulations related to the safe operations is the objective behind every action and decision by both those who oversee procedures and those who carry them out.

The operator had an SMS on the *Golden Ray* for use by its crew. The SMS included procedures for cargo operations, including crewmembers' duties during cargo operations, the amount of space required for stowing cargo, how to avoid damages while loading or offloading cargo, and how to secure cargo.

The SMS specified the duties of the master, chief officer, and other officers. According to the SMS, the master was responsible for shipboard education and training. During cargo operations, the chief officer was charged with managing loading/offloading and cargo-related work, including confirming the vessel's stability, while the master was responsible for confirming and monitoring the chief officer's cargo loading plan. The chief officer was also responsible for managing the vessel's ballast water, bilges, and fresh water; managing the SMS's control documents, drawings, and manuals of the deck department; and maintaining vessel records.

The SMS also had an Arrival/Departure Checklist that was required to be completed before the vessel's arrival at or departure from a port. The checklist required all the vessel's watertight doors to be closed and all hull openings to be secure and watertight upon departure from or when preparing for arrival at a port.

The SMS had been approved by the Korean Register of Shipping, and the vessel underwent regular SMS auditing. The operator's fleet management team conducted internal audits, and the Korean Register conducted external audits with the participation of the vessel's flag state (RMI). The operator conducted the vessel's most recent audit about a month before the accident on August 27, 2019, in Freeport, Texas, and no nonconformities were identified regarding the vessel or the crew's knowledge of SMS procedures.

⁹ The *International Safety Management Code* was developed by the IMO in the 1980s "to provide an international standard for the safe management and operation of ships and for pollution prevention." IMO, "ISM Code and Guideline of Implementation of the ISM Code," <https://www.imo.org/en/OurWork/HumanElement/Pages/ISMCode.aspx>, accessed June 30, 2021.

1.7.2 Shipboard Training

In a postaccident statement, the operator reported that they hired employees based on their previous experience, and “each of the vessel’s officers were experienced at their position, and none of the senior officers were serving in a position for the first time.”

The operator did not provide official training on crew positions and responsibilities to new crewmembers but instead relied on a combination of newly hired crewmembers’ experience and knowledge as well as on-the-job training. The chief officer stated that when he relieved the previous chief officer, he received 3–4 hours of on-the-job training, including how to use the vessel’s LOADCOM computer. He also stated that no one else on the ship knew how to use the LOADCOM computer, since calculating stability was the responsibility of the chief officer.

1.7.3 Cargo Operations

Preliminary Load Plan. For each port vehicle terminal that the *Golden Ray* was scheduled to visit in the United States, the charterer used a contractor (Norton Lilly) to develop a preliminary load plan (preload plan), which included compiling the proposed cargo to be loaded and offloaded and determining whether there was enough room on board the vessel for the proposed cargo at each port with the projected available space. The preload plan provided the specific location (deck and space) but not the weight of the vehicles to be loaded. The charterer sent the preload plan to the ship’s agent and to the vessel for the chief officer to review and determine whether the vessel could accommodate the weight of the cargo departing port while still meeting vessel stability requirements. The Norton Lilly personnel who prepared and reviewed the preload plan were not responsible for calculating the effect that the weight and placement of the cargo load would have on the stability of the vessel.

In the weeks leading up to the *Golden Ray*’s stop in Brunswick, the vessel visited four ports: Veracruz, Mexico (August 19-22); Altamira, Mexico (August 24-25); Freeport, Texas (August 27-30); and Jacksonville, Florida (September 6-7). In the days before the *Golden Ray* arrived at each port, the charterer sent the chief officer a preload plan specific to the upcoming port. Once the chief officer received a preload plan, he reviewed it and used the estimated weight and locations of the cargo being loaded and offloaded to determine whether the vessel would meet stability requirements with the changes in position and weight of the cargo. According to company procedures, if the chief officer did not believe that the vessel could safely accommodate the cargo and meet required vessel stability, he would coordinate with the charterer to determine how to adjust the preload plan to meet the stability requirements. The chief officer did not object to any of the preload plans for the Port of Brunswick or the four ports before. After loading operations were completed in each port, Norton Lilly emailed a final load plan to the charterer, who in turn emailed it to the vessel, typically within 12 hours after the vessel departed the port, with the vessel’s actual vehicle loading by deck area and vehicle type.

During the voyage to Brunswick, the charterer emailed the preload plan to the *Golden Ray*’s master and chief officer about 30 hours before the vessel was scheduled to arrive at the port, to review and determine if the vessel could accommodate the cargo to be loaded in Brunswick (see figure 13). The preload plan specified that a combination of 265 KIA Forté and Hyundai Accent vehicles from decks 11 and 12 were to be offloaded, and 362 KIA Telluride sport utility vehicles were to be loaded to decks 5, 11, and 12.

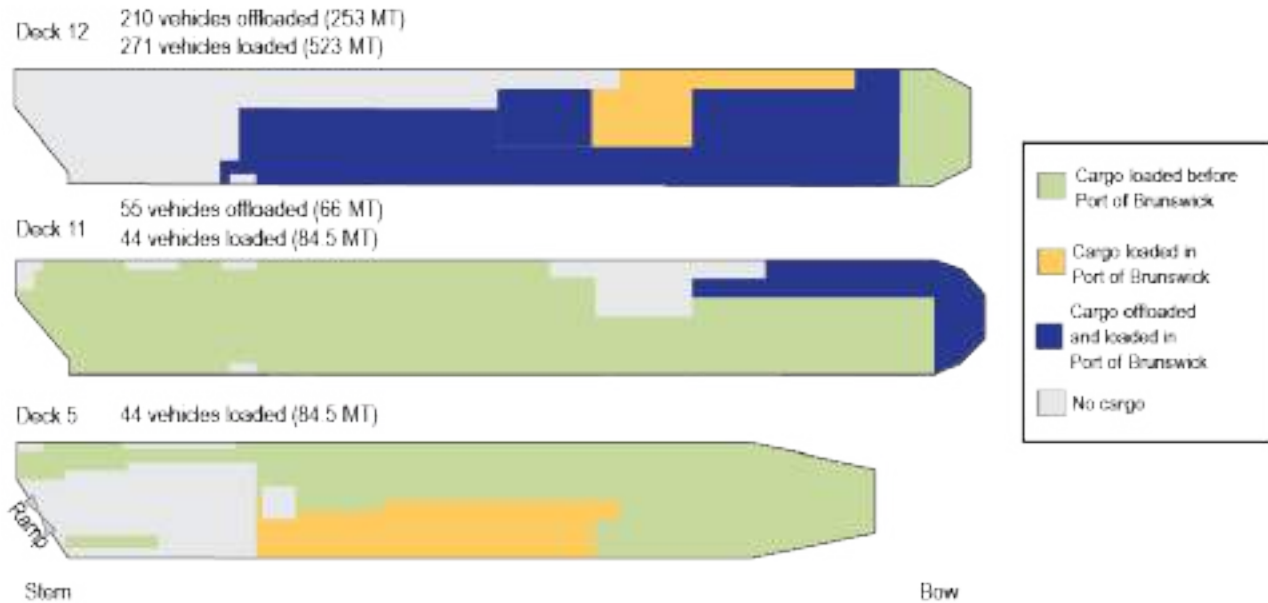

Background source: Hyundai Glovis

Figure 13. Preload plan (top view of decks 5, 12, and 13) for the *Golden Ray* at the Colonel's Island Terminal.

The chief officer stated that the preload plan that he received only contained the number and type of vehicles but did not contain the weight of each type of vehicle. (A postaccident review of the plan confirmed that the plan contained the number of vehicles and the total weight to be loaded in each loading location). Based on his experience, he estimated that each small vehicle being offloaded weighed 1.3 MT and each mid-sized vehicle being loaded weighed 2 MT, and he determined the total weight of the vehicles “based on the average weight of the given number of cars.” Using the stowage locations of the cargo provided in the preload plan and the estimated weight based on his calculations, the chief officer used the LOADCOM stability calculation program to determine the effect the cargo change would have on the vessel's stability. He concluded that the vessel would be able to accommodate the vehicles and meet stability requirements. He emailed the ship's agent to accept the preload plan before the vessel's arrival at the Port of Brunswick.

Loading and Offloading. According to his postaccident interview, before arriving in the Port of Brunswick on September 7, the chief officer briefed all officers and deck crew about the planned cargo operations, including “...loading, discharging, how many weights, and the lashing condition, and...checking the storage plan” in accordance with the company's SMS. Additionally, once in port, he met with stevedoring personnel from the Colonel's Island Terminal and the charterer's contracted plan clerk to discuss the day's operations. Before beginning loading operations, all vehicles were examined by stevedores for faults, including open doors or windows, leaking fluids, and disengaged hand brakes, and to ensure each vehicle's fuel tank was no more than 25% full.

Once loading operations began, the chief officer worked with the plan clerk and the superintendent of stevedoring to supervise loading operations. The chief officer was responsible for ensuring that all vehicles were properly stowed according to the preload plan and were secured in accordance with the vessel's cargo securing manual, while the plan clerk would confirm how

many vehicles were loaded during cargo operations. Unloading and loading were performed according to the preplan, with the exception of three vehicles originally included on the preload plan that were not loaded because of faults discovered during the stevedores' examination of the cargo; thus, a total of 359 KIA Telluride sport utility vehicles were loaded onto the vessel.

After the stevedores completed offloading and loading cargo, the chief officer worked with the plan clerk and stevedoring superintendent to confirm what was physically loaded. The chief officer sent this information directly to Norton Lilly, who began developing a final load plan with the actual load conditions, including the number, the estimated weight, and the stowage location of vehicles on each deck. Shoreside personnel reported no issues with or damage to the vessel's cargo securing lashings, and the crew reported no issues with the placement of the cargo.

Once Norton Lilly completed the final load plan, they would send the plan to the vessel, typically after the vessel had departed the port. The final load plan for the *Golden Ray's* cargo operations at Brunswick was emailed at 0259 on the day of the accident, which was almost 2 hours after the vessel capsized. Investigators' postaccident review of the final load plan showed that the total weight of the offloaded vehicles was 319 MT (1.2 MT each), and the total weight of the loaded vehicles was 692 MT (1.92 MT each). By the time cargo operations were completed, there were 4,161 vehicles on board, and the total cargo weight was 8,780.2 MT, an increase of 94 vehicles and an increase in cargo weight of about 373 MT from when the vessel arrived in Brunswick.

Calculating Vessel Stability. Following cargo operations and before the vessel's departure from a port, the chief officer was responsible for calculating the vessel's stability. The *Golden Ray* had on board a Trim and Stability (T&S) Booklet, which provided hydrostatic tables and stability and trim characteristics for 34 loading conditions to ensure the vessel had adequate stability before departure and during a voyage. If the GM calculated by the chief officer met the required threshold in the T&S Booklet, then the vessel was considered to be in compliance with the stability requirements of the booklet and of the International Code on Intact Stability, 2008 (2008 IS Code). The operator's SMS referred crewmembers to the T&S Booklet for stability guidelines.

The chief officer stated during a postaccident interview that he "calculated the stability and printed it out" using the LOADCOM computer. (The LOADCOM stability computer was designed to calculate stability in accordance with the T&S Booklet.) Before calculating the vessel's stability after loading operations were completed, the chief officer consulted the vessel's IMACS and had the quartermaster sound the tanks (ballast, fuels, and fresh water) to confirm that the IMACS tank level indicators were measuring correctly; he stated during the postaccident interview that the soundings were close to what the tank level indicator provided for the IMACS. The chief officer stated that he oversaw tank level soundings and personally observed and recorded the draft markings in order to enter them into the LOADCOM computer (this tank-sounding procedure was conducted daily). As stated earlier, the chief officer also consulted the preload plan to estimate the weight of the cargo loaded onto the vessel; he then entered it into the LOADCOM computer.

The chief officer entered the IMACS data for the ballast, fuels, and fresh water as well as the cargo weight into the LOADCOM computer to calculate the vessel's center of gravity. Although the LOADCOM computer was capable of automatically receiving IMACS data (such as ballast tank levels), according to the chief officer, he manually entered the necessary data from the IMACS into the LOADCOM computer. The IMACS also had a GM measurement feature that, if

used, automatically transferred ballast to heel the vessel up to 1° to either side and measured the quantity of ballast transferred to calculate the ship's GM. The postaccident review of the IMACS data revealed that the GM measurement program was not used before the vessel departed on the accident voyage from Brunswick. The LOADCOM computer did not calculate the vessel's vertical center of gravity (KG)—that is, the distance from the bottom of the hull (or keel) to the center of gravity.

The operator's SMS provided the following guidelines for using the LOADCOM computer: "the stability as calculated by using [LOADCOM] must be OK condition and above the IMO required Min. GM for that condition." Once the chief officer finalized the stability calculations using the LOADCOM computer, he reported to the master the vessel's GM, which he calculated to be 2.45 meters (8.3 feet) (and which he reported the LOADCOM said "was ok"), and draft, which he determined to be 30.8 feet (9.4 meters) forward, 30.9 feet (9.3 meters) midships, and 31.2 feet (9.5 meters) aft (the same fore and aft drafts reported by the pilot in the master/pilot exchange). The master, who was required by the operator's SMS "to be satisfied that the ship has sufficient stability at all times," did not review the chief officer's calculations or report any issues with the chief officer's calculations to the company.

Typically, the master would then generate a departure report, which included the vessel's calculated GM and draft, and send it to the operator's fleet management team for their records. However, according to the master, the Brunswick departure report for the vessel was not sent before the accident because they were in a "standby situation," and they had not yet dropped the pilot off outside the channel.

1.8 Stability

A vessel that is floating upright in still water will list, or heel over to an angle, when an off-center force is applied. Stability is the vessel's tendency to return to its original upright position when the force is removed. See [Appendix C, "Principles of Stability,"](#) for more information.

1.8.1 International Code on Intact Stability, 2008 Requirements

The 2008 IS Code provides intact stability standards in two parts—mandatory criteria and recommended criteria. For cargo and passenger vessels at least 24 meters (79 feet) long, including the *Golden Ray*, the 2008 IS Code required two types of intact stability criteria: (1) the vessel's righting arm curve and (2) severe wind and rolling.

According to the criteria, the area under the righting arm curve was required to be no less than 0.055 m-radians up to an angle of heel of 30°, or no less than 0.09 m-radians up to an angle of 40°. ¹⁰ Additionally, the righting arm was required to be at least 0.2 meters (0.7 feet) at an angle of heel equal to or greater than 30°, and the maximum righting arm could not occur at an angle less than 25°. Further, the vessel's initial GM was required to be no less than 0.15 meters (0.5 feet).

The severe wind and rolling criteria contained within the 2008 IS Code required that the vessel's angle of heel under action of a steady wind not exceed the lesser of 16° or 80% of the angle of deck edge immersion. Additionally, the vessel's available or potential energy to resist

¹⁰ An *m-radian*, or meter-radian, is a measure of area under a ship stability righting arm curve.

capsizing to leeward was required to be equal to or greater than the stored energy due to the roll angle to windward.

1.8.2 NTSB Performance Study

After the accident, the NTSB used data from the *Golden Ray*'s VDR and IMACS to determine the forces acting on and their effect on the vessel at the time of the accident. The study showed that from an initial heel of about 8° at 0136:00, the vessel heeled past 50° in about 50 seconds (by 0136:50) and reached over 60° in less than a minute, while its starboard rate of turn increased from about 2° per minute to over 40° per minute (see figure 14).

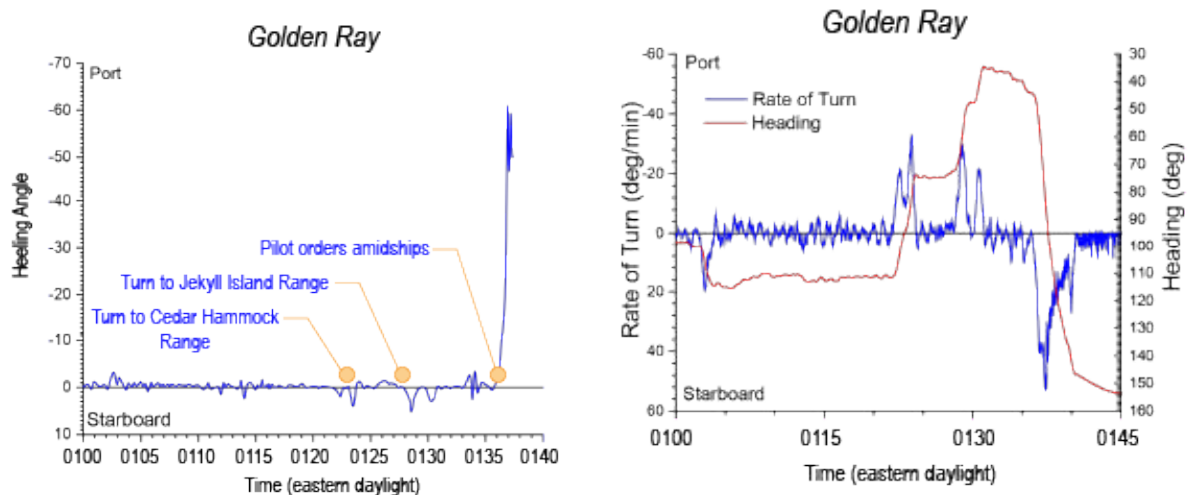

Figure 14. Graphs from the *Golden Ray* performance study by the NTSB. Left: heeling angle through the transit, including previous two left turns. Right: heading and rate of turn through the transit.

According to the study, the heeling of the vessel was driven by a moment created by hydrodynamic side force on the hull at a distance below the center of gravity during a starboard turn at 12–13 knots. The hydrostatic stability (buoyancy) resisting the heel was much less than would be expected for the reported GM of 2.45 meters (8 feet) and instead was consistent with a GM of approximately 0.45 meters (1.5 feet). The study also found that although the effect of wind could not be calculated precisely, the low magnitude of the heeling moment from wind relative to other sources of heeling moment was not significant. The study found that the vessel's center of gravity was significantly higher than reported, leading to the lack of roll resistance.

1.8.3 Marine Safety Center Analysis

Accident Analysis. As part of its investigation of the accident, the Coast Guard's Marine Safety Center (MSC) completed a forensic stability analysis of the *Golden Ray* using a computer model of the cargo weights contained on the final load plan and the liquid load quantities (fuel oil, lube oil, fresh water, ballast, wastewater) retrieved from the IMACS computer as the ship departed the Port of Brunswick on September 8 (Coast Guard 2020).

Considering the final load plan and IMACS data, the MSC used the *Golden Ray*'s T&S Booklet to find the vessel's required minimum GM and maximum KG for the corresponding drafts and trim on the accident voyage (see [Appendix C](#) for principles of stability). The MSC found that

the vessel's minimum GM, according to the T&S Booklet, should have been 2.54 meters (8.3 feet). The MSC analysis determined that on the accident voyage, the *Golden Ray* had a GM of approximately 1.76 meters (5.8 feet), below both the minimum 2.54 meters (8.3 feet) required by the T&S Booklet and the 2.45 meters (8 feet) reported by the chief officer. The MSC also determined that the vessel's KG on the accident voyage was 18.2 meters (58 feet), approximately 3.8% higher than the T&S Booklet's required maximum KG of 17.5 meters (57.4 feet).

Additionally, to simulate the accident voyage, the MSC compared the cargo and liquid loads on board the *Golden Ray* at the time of the accident to similar loading conditions found in the T&S Booklet. The T&S Booklet had 34 loading conditions for various cargo, fuels, and ballast scenarios that might typically be encountered during a voyage, such as "Normal Ballast Condition Arrival" and "Docking." These 34 conditions had been demonstrated to result in adequate vessel stability. Of those 34 conditions, the MSC found 6 that were similar to the vessel's loading condition on the accident voyage (see figure 15) and used these as "benchmark" conditions for comparison. The booklet had two loading conditions (conditions 17 and 18) that had similar cargo vertical centers of gravity, but on the accident voyage, the vessel had over 40% less ballast, fuels, and fresh water (liquid loads) in its tanks, as well as 12% more cargo weight, than these benchmark conditions. Two other loading conditions (conditions 13 and 14) had similar total liquid loads as the *Golden Ray*, but on the accident voyage, the vessel had a cargo vertical center of gravity 20% higher than these conditions, as well as about 1,500 MT (about 17%) more cargo weight. Lastly, the MSC chose two other conditions (conditions 19 and 20) for comparison due to the similar cargo weight carried (8,780.2 MT on the accident voyage), as they only had about 900 MT more cargo weight than the accident voyage. However, on the accident voyage, the vessel had 2,900 MT less liquid load than these conditions.

	Ballast (MT)	Bunkers (MT)	Total Liquid (MT)	Cargo Weight (MT)	Cargo VCG (m)	Vessel VCG (m)	Total Disp. (MT)
MSC Capsize Voyage	2981	1619	4601	8780	24.3	18.2	35044
T&S Condition 17	2766	4233	7000	7742	24.2	17.1	36175
T&S Condition 18	5463	1066	6529	7742	24.2	17.0	35704

	Ballast (MT)	Bunkers (MT)	Total Liquid (MT)	Cargo Weight (MT)	Cargo VCG (m)	Vessel VCG (m)	Total Disp. (MT)
MSC Capsize Voyage	2981.45	1619.2	4601	8780	24.3	18.2	35044
T&S Condition 13	320	4233	4553	7267	19.4	17.0	33253
T&S Condition 14	3117	1066.2	4183.2	7267	19.4	16.8	32884

	Ballast (MT)	Bunkers (MT)	Total Liquid (MT)	Cargo Weight (MT)	Cargo VCG (m)	Total VCG (m)	Total Disp. (MT)
MSC Capsize Voyage	2981	1619	4601	8780	24.3	18.2	35044
T&S Condition 19	3282	4233	7515	9670	24.2	17.2	38619
T&S Condition 20	6601	1066	7667	9670	24.2	16.9	38771

Source: Coast Guard

Figure 15. Comparison of loading conditions determined by MSC postaccident analysis on the *Golden Ray's* accident (capsize) voyage to conditions 17 and 18, 13 and 14, and 19 and 20 in the T&S Booklet. Total liquids loads are a sum of ballast and bunkers (fuels). Green highlights the requirements of each loading condition that the *Golden Ray* met, while red highlights requirements that the vessel failed.

In order to determine the vessel's intact stability, the MSC generated righting arm curves for the *Golden Ray*, and the results were compared with the 2008 IS Code standards for stability. Both righting arm curves generated by the MSC had "significantly lower righting arms and area under the righting arm curve than all benchmark conditions from the T&S Booklet." When 2008

IS Code criteria were applied to these righting arm curves, the MSC found that with the vessel's loading condition, the area under the vessel's righting arm curve between 30° and 40° was particularly limited, and it failed to meet the 2008 IS Code (see figure 16). Because there was limited area under the righting arm curve, the MSC determined that the vessel did not meet the area ratio criteria of the 2008 IS Code's severe wind and rolling criteria. The MSC concluded that the vessel, as loaded, had an extremely low righting energy, which prevented it from withstanding further adverse static or dynamic heeling effects and enabled the vessel to capsize due to the centrifugal force experienced by the vessel throughout the starboard turn.

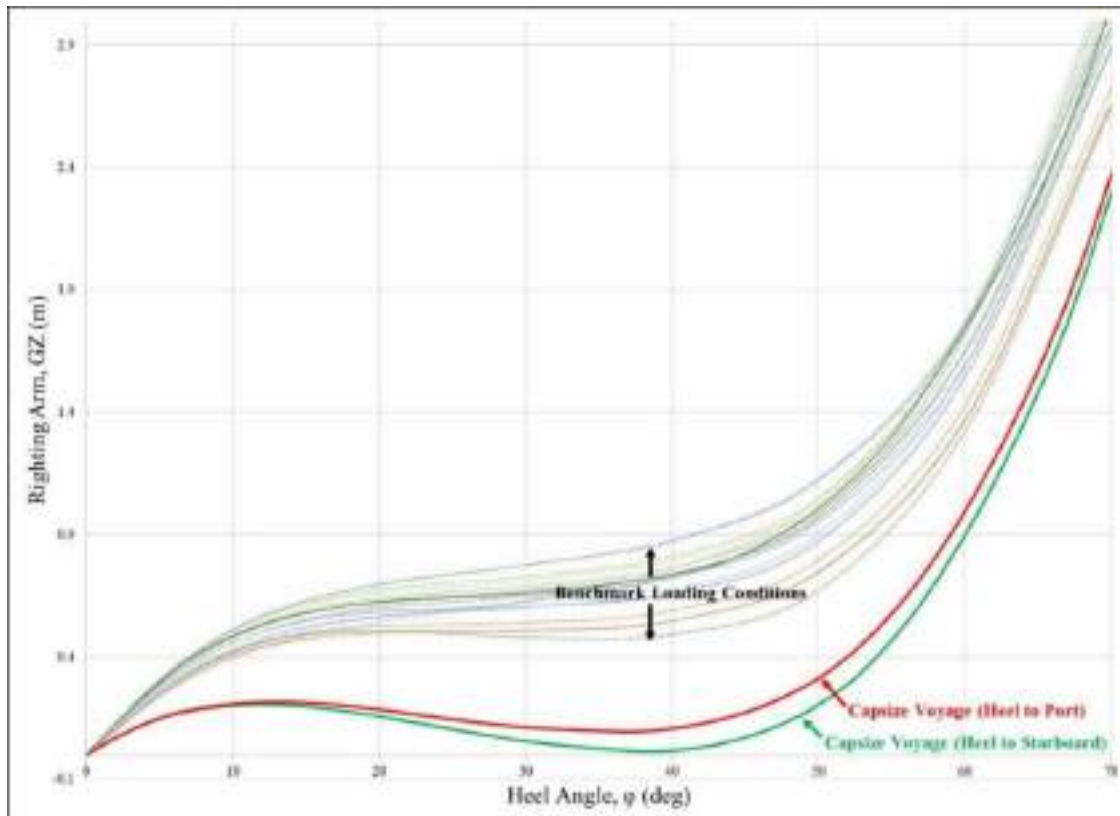

Source: Coast Guard

Figure 16. Righting arm curves generated from the MSC analysis of the *Golden Ray* during the accident voyage compared with benchmark righting arm curves chosen from the vessel's T&S Booklet loading conditions.

Previous Voyage Stability Analysis. The MSC conducted additional analyses to assess the vessel's intact stability during the two voyages before the accident voyage: Freeport, Texas, to Jacksonville, Florida, and Jacksonville, Florida, to Brunswick, Georgia. The master provided to the operator departure reports, each with a stability section prepared by the *Golden Ray*'s chief officer, when the vessel departed the ports of Freeport, Texas, and Jacksonville, Florida. Shoreside personnel from the operator reviewed the information contained within the departure reports but were not responsible for evaluating or checking the data to ensure it was accurate and complied with the vessel's T&S Booklet. The reports showed that the chief officer's calculated GM for the vessel was 1.96 meters (6.4 feet) when it departed both ports. However, based on the respective cargo final load plans and IMACS liquid loading data, the MSC determined that the vessel likely had a GM of 1.84 meters (6 feet) when it departed Freeport and 1.91 meters (6.3 feet) when it departed Jacksonville.

The MSC analysis also found that, although the vessel had more righting energy for the two preceding voyages than during the planned accident voyage, it was not in compliance with all of the minimum righting arm requirements of the 2008 IS Code during either because the area under the vessel's righting arm curve between 30° and 40° was insufficient. The MSC report stated that "failure of the IS Code criteria...is an indicator that the vessel poses a higher risk of capsize given exposure to certain dynamic conditions such as severe wind, waves and faster speed/tighter radius turns," and it was possible that the *Golden Ray* "could have capsized on a previous voyage if it had been exposed to more severe adverse conditions."

The MSC report also stated that if the *Golden Ray* had maintained an additional 1,492 MT of ballast (1,500 MT was loaded after departure from Freeport and then discharged before the vessel arrived in Jacksonville in order to meet the port's draft requirements), the vessel would have been in compliance with the 2008 IS Code during both previous voyages and the accident voyage (see figure 17). The MSC also noted that, with the additional ballast, the vessel's theoretical initial GM for those voyages would have been 2.25 meters (7.4 feet) for the accident voyage, 2.4 meters (7.9 feet) for the voyage from Freeport, and 2.47 meters (8.1 feet) for the voyage from Jacksonville. (For comparison, the MSC calculated the initial GM for the representative loading condition to be 1.76 meters (5.8 feet) for the accident voyage, 1.84 meters (6 feet) for the voyage from Freeport, and 1.91 meters (6.3 feet) for the voyage from Jacksonville.)

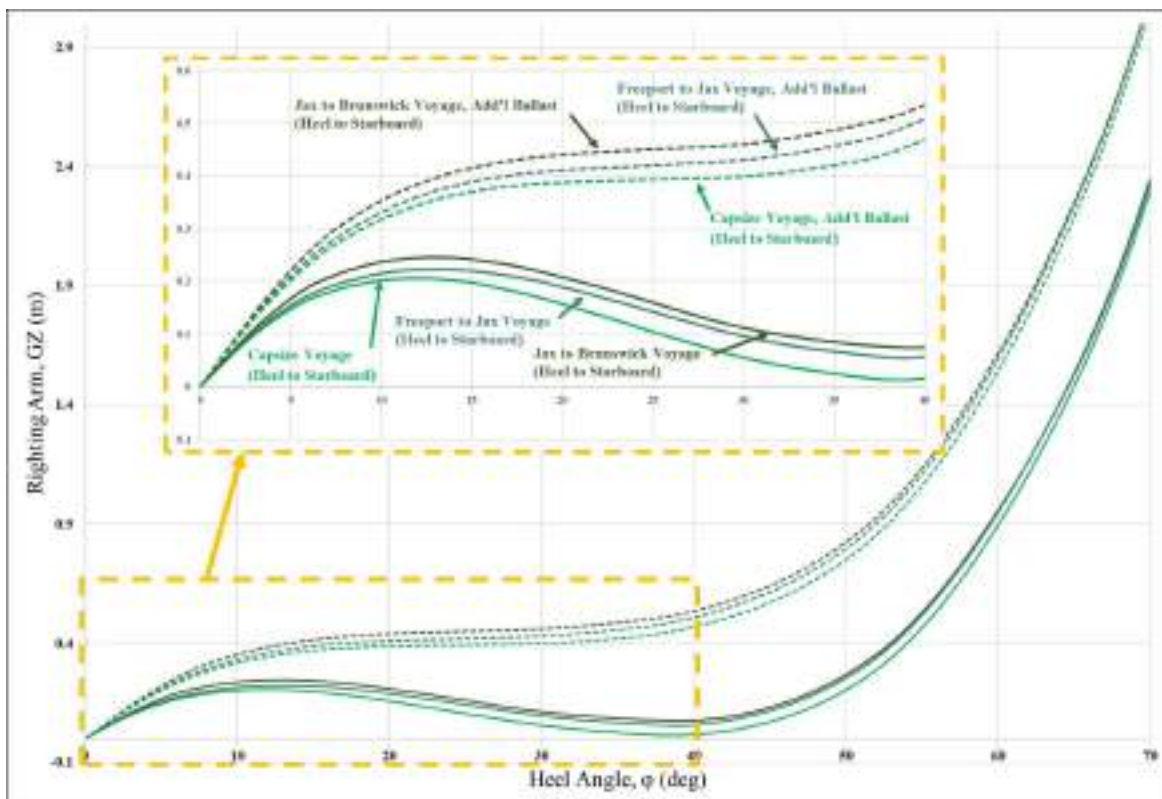

Source: Coast Guard

Figure 17. Theoretical righting arm curves (dashed green lines) generated from the MSC analysis of the *Golden Ray* during the accident voyage and previous two voyages with an additional 1,492 MT of ballast. The righting arm curves (solid green lines) generated from the MSC analysis for the vessel in the representative loading condition for each voyage are shown for comparison.

Downflooding. As part of its analysis, the MSC assessed the downflooding to the ship from the open portside pilot door on deck 5. Downflooding occurs when an opening, such as a vent or hatch—or downflooding point—in a vessel’s hull or superstructure becomes immersed and allows water to flood into the vessel. The lowest angle that a vessel’s heel would immerse a downflooding point (in this case, the open portside pilot door) is referred to as the downflooding angle.

The analysis determined that with the vessel in its loaded condition, the downflooding angle was reduced to approximately 17° when the vessel heeled to port (as compared to a downflooding angle of 83° with the pilot door and all other weathertight and watertight hull doors closed). As a result, the water entered the area of the open pilot door as the vessel heeled past 17°, causing flooding onto deck 5. According to the MSC, as the vessel continued to heel over, the progression of water into the interior of the vessel most likely continued through open hatches and non-watertight doors as well as ventilation ducts.

1.8.4 Additional Postaccident Analyses

Korea Maritime Safety Tribunal. The Korea Maritime Safety Tribunal (KMST), an agency that investigates maritime accidents on behalf of the South Korean Government, was invited by the Coast Guard to be a party to the investigation in accordance with the IMO Casualty Investigation Code.¹¹ The KMST also conducted a preliminary stability analysis of the *Golden Ray* and came to a similar conclusion to the Coast Guard’s determinations. The KMST determined that the vessel’s departure GM from Brunswick was approximately 1.8 meters (5.9 feet) and the vessel had an extremely low righting energy to counter the heeling of the vessel to port.

Hyundai Glovis. The charterer conducted a simulated stability analysis of the *Golden Ray* using the LOADCOM computer on board the *Silver Ray*, a vessel of the same class as the *Golden Ray* (Hyundai Glovis Co. Ltd. 2020). This simulation used vessel data and conditions collected by the charterer and was not observed by the Coast Guard or the NTSB. The simulation calculated that the GM of the *Golden Ray* was 1.8 meters (5.9 feet), indicated that the righting arm curve for the *Golden Ray* at the time of the accident was extremely low, and showed a LOADCOM status of “Not OK” for three stability requirements (see figure 18). Additionally, the righting arm curve showed negative stability after a heel of about 25°.

¹¹ Established by the IMO in 1997, the Code of the International Standards and Recommended Practices for a Safety Investigation into a Marine Casualty or Marine Incident (Casualty Investigation Code) provides standards and best practices for an objective marine accident investigation.

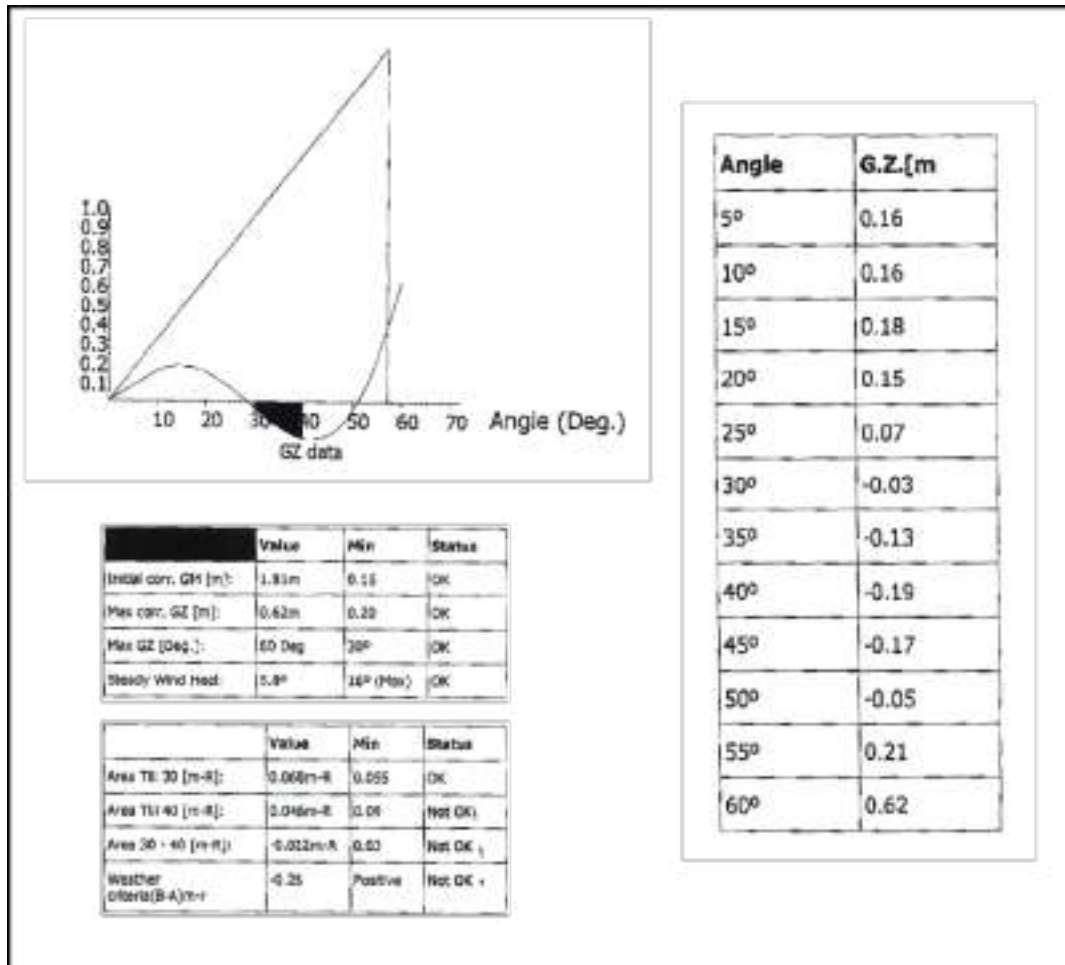

Source: Hyundai Glovis Co. Ltd.

Figure 18. Righting arm curve calculated on the *Silver Ray's* LOADCOM stability computer based on the *Golden Ray's* vessel data from the accident. Note that three of the stability requirements have a status of “Not OK” and the righting arm (GZ) is negative beyond 25°.

1.8.5 Transportation Research Board

Before the accident, in 2018, the Transportation Research Board (TRB) Marine Board (a division of the US National Academies of Sciences, Engineering, and Medicine) published *Review of U.S. Coast Guard Vessel Stability Regulations* in which they reviewed Coast Guard regulations and policies establishing stability requirements for US-flagged vessels and suggested ways in which the requirements could be better aligned with international standards and improved for consistency and clarity (National Academies of Sciences, Engineering, and Medicine 2018). As part of the study, the TRB reviewed a number of marine accidents involving Ro/Ro vehicle carriers. The TRB also noted that many of these accidents “illustrate[d] the importance of considering human error when developing regulations.” The TRB further stated,

In vessel types, such as car carriers that have a higher susceptibility to stability losses to begin with (because of features such as high freeboard [sail area] and cargo located at high deck levels), the potential for risk arising from human error in regulatory compliance cannot be neglected and should factor into assessments of regulatory content, design, and effectiveness.

1.8.6 SOLAS Amendment

On January 1, 2020, an amendment to *SOLAS* II-1/20 came into effect. The new amendment required that

on completion of loading of the ship and prior to its departure, the master shall determine the ship's trim and stability and also ascertain and record that the ship is upright and in compliance with stability criteria in relevant regulations. The determination of the ship's stability shall always be made by calculation or by ensuring that the ship is loaded according to one of the precalculated loading conditions within the approved stability information. The Administration may accept the use of an electronic loading and stability computer or equivalent means for this purpose.

These requirements were previously only applicable to passenger ships but were amended to include cargo ships.

1.9 Waterway Information

1.9.1 General Information

Maintained by the US Army Corps of Engineers, Savannah District, the navigation channel for the Port of Brunswick was 16 miles long and had a regulated depth of 38 feet (11.6 meters) at low tide outside the port and 36 feet (11 meters) at low tide within the port. The channel was between 400 and 500 feet (122 and 152.4 meters) wide and allowed for two-way vessel traffic. The average tidal range in the port was approximately 7 feet (2.1 meters). The channel bottom consisted of mostly sand and silt with some limestone in the Brunswick Harbor. The waterway also consisted of six wideners, designated areas that allowed transiting vessels a larger area to turn when moving from one portion of the waterway to another.

St. Simons Sound was located between Jekyll Island to the south and St. Simons Island to the north. It was part of the Brunswick River where the river entered the Atlantic Ocean.

1.9.2 Navigation Channel Surveys

The Corps of Engineers, Savannah District, working with the National Oceanic and Atmospheric Administration (NOAA), monitored the depth of the navigation channel monthly with underwater surveys and scheduled dredging to maintain the channel's regulated depth. Underwater surveys were conducted by having a vessel tow either a single-beam, multi-beam, or side scan sonar in a set pattern over the channel to record the condition. These underwater surveys did not include the areas of the chart identified as wideners since they are not part of the regulated channel maintained by the Corps of Engineers. The results of these surveys were shared with the Coast Guard, Brunswick Bar Pilots Association, and the Port Authority.

On September 4, 2019 (4 days before the accident), Hurricane Dorian impacted the Port of Brunswick. The Corps of Engineers, working with NOAA, conducted a hydrographic survey of the channel from September 5 to 6 to ensure it was safe for navigation. There were no safety concerns noted in the survey.

Following the capsizing of the *Golden Ray*, the Corps of Engineers and NOAA conducted two extensive hydrographic surveys of the channel by buoy 20, widener 11, and buoy 19 on September 9 and 11. According to the Corps of Engineers, neither of the surveys found any anomalies or any indications that the vessel struck the bottom of the sound in the channel or the widener. In addition, the Corps of Engineers reported that channels were at or greater than regulated depth and that widener 11, which the *Golden Ray* passed over before coming to rest on its port side outside of the channel, had a depth of 50 feet (15.2 meters).

1.10 Meteorological Information

The accident occurred during nighttime hours. At the time of the accident, skies were partly cloudy, with visibility up to 10 miles. The recorded air temperature was 75°F, and the water temperature was 82.5°F. Winds were southwest about 4 knots.

1.11 Postaccident Actions

1.11.1 Coast Guard

On September 9, 2020, the Coast Guard announced the convening of a Marine Board of Investigation into the capsizing of the *Golden Ray*. The Marine Board of Investigation membership included the Coast Guard, the NTSB, the RMI, the KMST, representatives for the charterer and the operator, and the Brunswick Bar Pilots Association. The formal hearing was held on September 14–18, 2020, and September 21–22, 2020. The chief officer of the *Golden Ray* declined the invitation to be interviewed at the hearing.

Among the issues reviewed during the hearing were conditions at the Port of Brunswick; the loading process at the port; the vessel operator's organizational structure, oversight, and culture; and the regulatory compliance record of the vessel.

1.11.2 Republic of the Marshall Islands

In October 2020, the RMI issued Marine Safety Advisory 29-20, "Maintaining Intact Stability – Reminder" to all RMI-flagged ships, detailing the requirements and recommendations for maintaining intact stability. The advisory included information on properly completing vessel stability calculations and ensuring compliance with the relevant stability booklet; the responsibility of masters and owners to ensure that their vessels comply with applicable stability requirements; and the importance of company oversight as a means to verify a vessel's compliance with stability requirements.

In January 2021, the RMI issued Marine Notice 2-015-1, "Intact Stability, Damage Stability, and Strength of Vessels" to all RMI shipowners, operators, masters and officers of merchant ships, and recognized organizations. The notice incorporated the new requirements under *SOLAS* II-1/20 and clarified the requirements for intact stability, damage stability, longitudinal strength, and damaged structural strength.

1.11.3 G-Marine Service Co. Ltd.

As a result of the accident, the vessel's operator implemented several policies to improve safety and reduce the likelihood of another similar accident. The company increased the training required for chief officers on topics including stability, calculation of draft, cargo management, and proper use of the LOADCOM computer. Additionally, the company revised its procedures throughout the fleet so that chief officers would be required to compare the calculated GM from the LOADCOM computer with the minimum required GM for a similar loading condition in the T&S Booklet, with both numbers required on the vessel's departure report. A table of vessel-specific minimum GMs from the T&S Booklet was also posted in each vessel's cargo office and bridge.

The company completed a case review of the *Golden Ray* accident with all the company's senior officers and enhanced its procedures for all masters and officers to receive refresher training for the LOADCOM computer prior to boarding. The company further revised its load plan procedures so that vessels would only be able to depart a port after receiving a final load plan and verifying the stability of the vessel based upon the final load plan. The operator also required "enhanced focus" on stability by vessel superintendents during onboard audits, including the use of hard copy records and LOADCOM computer data.

Finally, the company began an initiative to standardize the make and type of stability computer used throughout its fleet, replacing the LOADCOM computer with a "more user-friendly stability computer system."

2. Analysis

2.1 Introduction

About 0100 on September 8, 2019, after unloading and loading vehicle cargo during the previous day, the 656-foot-long, RMI-flagged Ro/Ro vehicle carrier *Golden Ray* departed the Colonel's Island Terminal in the Port of Brunswick, Georgia, en route to Baltimore, Maryland. A state pilot from the Port of Brunswick navigated the vessel as it proceeded outbound through the Brunswick River and into St. Simons Sound. The pilot navigated the vessel through two left turns, and, as the vessel approached the right turn into Plantation Creek Range, which led to the Atlantic Ocean, the pilot gave rudder orders to the helmsman to turn the vessel to starboard. As the vessel turned to starboard, it began to heel quickly to port.

The pilot and the vessel's master began rapidly issuing rudder commands in an attempt to counter the heeling. However, the *Golden Ray* continued to heel over, the rate of turn to starboard increased, and the vessel heeled to port to about 60° in less than a minute. Water entered deck 5 through the vessel's open portside pilot door and flooded through open watertight doors to the engine and steering gear rooms. The vessel eventually settled on its port side at an angle of 90°.

The Coast Guard responded to the accident, along with tugboats and pilot boats from the port, first responders from the Georgia Department of Natural Resources and Glynn County, and vessels from Sea Tow. Responders were initially able to rescue the pilot and 19 of the 23 crewmembers on board. Four engineering crewmembers remained trapped in the engine room until the following day, September 9, when responders cut into the vessel's hull to rescue them. Two crewmembers suffered serious injuries. Total costs for the loss of the vessel were estimated at \$62.5 million, and total costs for the loss of the cargo were estimated at \$142 million.

This analysis evaluates the following safety issues:

- Improperly calculating vessel stability (section 2.2.3) and
- Lack of company oversight for calculating vessel stability (section 2.3).

Having completed a comprehensive review of the circumstances that led to the accident, the investigation excluded the following as causal factors:

- *Weather.* At the time of the accident, skies were partly cloudy with visibility up to 10 miles, and winds were light at 4 knots. Additionally, the NTSB's postaccident performance study of the *Golden Ray* determined that the effect of the wind at the time of the accident was not significant.
- *Transfer of ballast or fuel.* A review of the *Golden Ray*'s IMACS data showed that at the Colonel's Island Terminal in the Port of Brunswick, there were only marginal changes to the amount of fuel on board, and there were no changes to the amount of ballast the vessel carried while it was in port. After completing cargo operations (offloading and onloading of vehicles) the chief officer transferred ballast water between heeling tanks to reduce the vessel's list from 0.42° to port to 0.03° to starboard—nearly even keel. The recovered IMACS data showed that after the vessel departed the terminal, there was no further transfer of ballast or fuel prior to the accident.

- *Propulsion and steering systems.* The master had navigated the *Golden Ray* during two previous voyages (from Freeport to Jacksonville and from Jacksonville to Brunswick) without issue, and, once the vessel arrived at the Port of Brunswick, the state pilot successfully navigated the vessel into the port without incident. During the accident transit, the vessel responded to engine and steering orders; neither the pilot nor the crew reported any issues with the vessel's propulsion or steering systems. In addition, the pilot did not mention any mechanical issues or concerns when he reported the accident to the *Emerald Ace* pilot and the Coast Guard.
- *Cargo shift.* After cargo operations were completed, the vessel was carrying 4,161 vehicles, each placed in accordance with the preload plan. Shoreside personnel reported no issues with or damage to the vessel's cargo lashings, and the crew reported no issues with the placement of the cargo. Prior to the heeling event, there was no indication from the vessel's crew or VDR that cargo shifted.
- *Grounding.* In both the inbound transit into the Colonel's Island Terminal and the vessel's initial voyage out of the Port of Brunswick, the pilot reported no issues with either the vessel or the channel. The Corps of Engineers and NOAA had conducted a survey in St. Simons Sound on September 4, 2019, four days before the accident (due to Hurricane Dorian) and found no foreign objects in the channel; additionally, the channel bottom was at the regulated depth of 38 feet (11.6 meters) at low tide. Two similar hydrographic surveys conducted in the days immediately following the *Golden Ray's* capsizing and sinking confirmed that the channel depth met or was greater than the regulated depth, and widener 11 had a natural depth of 50 feet (15.2 meters). Before departure, the vessel's draft readings were 30.8 feet (9.4 meters) forward and 31.2 feet (9.5 meters) aft, which met the required underkeel clearance of a minimum 3 feet (0.9 meters) in the 38-foot-deep (11.6-meter-deep) channel. The surveys also found no obstructions in the channel that the vessel could have struck, nor any indication that the vessel struck the bottom of the channel.
- *Cargo hold fire.* After the *Golden Ray* capsized and rescue operations were ongoing, the crew and first responders heard the sound of loads crashing within the vessel. Later, during rescue operations, a fire was reported in the area of the vehicle decks. Before 0138, there were no fire alarms reported by the crew or recorded by the VDR, which would have indicated if the fire began before the heeling event. Investigators were not able to determine the exact time that the fire started or the exact ignition source. However, the dynamic environment of the vessel heeling and the vehicles, which contained partially (up to 25%) full gasoline fuel tanks, shifting and striking each other and the vessel's structure in the cargo hold likely caused some fuel to leak from the vehicles and provided an initial fuel source for a fire. As the vessel heeled, the vehicles would have crashed into each other, likely creating sparks that could have ignited the leaking fuel. The cargo hold also contained combustible materials, including tires and plastic components in the vehicles, which would have provided fuel for the fire. Thus, it is likely the fire occurred after the vessel capsized.

Thus, the NTSB concludes that none of the following safety issues were identified for the accident transit: (1) weather; (2) a transfer of ballast or fuel; (3) the propulsion and steering systems; (4) the shifting of cargo within the vessel; (5) obstructions in the channel that could have caused the vessel to ground; or (6) the cargo hold fire.

2.2 Stability

2.2.1 Heeling Event

After departure, at 0122, the vessel made a 38° port turn (the pilot used up to 20° rudder) at 11.6 knots, resulting in a 4° heel to starboard. At 0128, the vessel made another 38° port turn (again, the pilot used up to 20° rudder) at a slightly faster speed, and the heel to starboard reached 6°. The vessel returned to its normal upright position (0° heel) after each turn was completed, and there were no indications from the crew or the IMACS heel angle data graphed in the NTSB's performance study that the vessel had an excessive heel during those turns.

At 0136:08, the *Golden Ray* approached the 68° starboard turn at widener 11 in the channel into the Plantation Creek Range, and the pilot ordered 10° starboard rudder. At this point, there was no indication from the pilot or crewmembers on the bridge that there were any concerns with the vessel, and there were no alarms sounding on the bridge. Shortly after, the pilot ordered 20° starboard rudder at 0136:39. Seconds later, at 0136:47, the pilot ordered the rudder returned to midships, and, 11 seconds later, the vessel started to heel significantly to port. At this time in the VDR playback, the bridge crew could be heard expressing surprise at the heel. While the pilot ordered the helmsman to move the rudder to port to counter the increasing heel, the rudder input did not arrest the heel, and the vessel reached a heel of 60° to port in less than a minute before it grounded on the shallow area outside of the channel and the widener.

As a vessel moves through a steady turn, it is subjected to lateral forces, including centrifugal force that acts normal to the direction of the vessel's forward velocity at its center of gravity. During a turn, water pressure creates an equal and opposite force, thereby causing the vessel to heel in the opposite direction of the turn. If a vessel has enough righting energy, it will return to a normal, upright position.

A postaccident stability analysis by the Coast Guard MSC found that the *Golden Ray* possessed significantly less righting energy than the nearest similar loading (benchmark) conditions found in the vessel's T&S Booklet. The analysis concluded that there was an extremely low righting energy present to prevent the vessel from withstanding further adverse static or dynamic heeling effects, which enabled the vessel to capsize due to the centrifugal force experienced by the vessel throughout the starboard turn leading up to the capsizing. Further, two other postaccident analyses—one conducted by the KMST and a second by the charterer (Hyundai Glovis) using the same LOADCOM stability computer found on the *Golden Ray* (installed on the *Silver Ray*, a vessel of the same class)—found that the vessel had extremely low righting energy to counter heeling forces.

The *Golden Ray* used up to 20° of rudder to execute two turns to port as the vessel made two 38° course changes just 14 and 8 minutes before the starboard turn that resulted in the capsizing. There was no recorded ballast transfer after the vessel's departure, effects of the 4-knot winds were found to be negligible, and there was no known cargo shift. The vessel completed the previous two turns to port at a slightly slower speed (11.6–12 knots) that likely did not generate the forces required to initiate a heeling event. The *Golden Ray*'s speed increased slightly to 13.3 knots, a normal transit speed for the vessel in the channel, as the pilot prepared to turn into the Plantation Creek Range. As the *Golden Ray* attempted to move through this starboard turn—again, using no more than 20° rudder—the vessel began a rapid and sustained heel that capsized the vessel by overcoming the vessel's righting energy and resulting in its inability to return to an

upright position. The NTSB concludes that the *Golden Ray* capsized because it did not possess enough righting energy to counter the port heeling moment created during the attempted execution of the 68° starboard turn at widener 11.

2.2.2 Vessel Stability and Loading Condition

After the accident, to determine the vessel's intact stability, the MSC generated righting arm curves for the *Golden Ray* in accordance with the loading conditions recorded in the IMACS data and compared the results with the 2008 IS Code standards for stability. Stability criteria are generally recognized as providing an adequate level of safety for vessels that are operated prudently, which means not overloaded and not operating in dangerous conditions such as violent storms. A margin of safety is built into the stability criteria that is intended to accommodate events that can happen to a vessel, such as rolling in waves, heeling due to wind, or listing as people or cargo move from side to side. Because of the margin of safety in regulatory stability criteria, a vessel may be functionally stable even if it does not meet the criteria. The only way to tell if a vessel meets stability criteria is through calculations. Based on the MSC's postaccident calculations and analysis, the *Golden Ray* was not in compliance with 2008 IS Code standards for stability, since the area under the righting arm curve between 30° and 40° was insufficient, and the vessel did not meet severe wind and rolling criteria.

Postaccident analyses conducted by the NTSB, MSC, and KMST determined that the *Golden Ray*'s GM at the time of the heeling was between 0.8 and 1.8 meters (2.6 and 5.9 feet), well below the GM of 2.45 meters (8 feet) reportedly calculated in the LOADCOM computer by the chief officer and provided to the master and the charterer. According to the MSC's analysis, at the time of the accident, the vessel's GM should have been a minimum of 2.54 meters (8.3 feet)—approximately 30% higher than the MSC's determination of the vessel's GM (1.76 meters, or 5.8 feet)—to be in accordance with the *Golden Ray*'s T&S Booklet. Additionally, the MSC found that the vessel's KG was approximately 4% above the maximum KG permitted by the T&S Booklet. Lastly, the MSC compared the six most similar loading conditions from the T&S Booklet to the vessel's loading condition during the accident voyage. They found that the actual ballast amount was too small for a similar cargo weight, the actual cargo weight was too large for a similar ballasting, and the actual liquid load was too small for a similar cargo weight.

The MSC's analysis found that with 1,492 MT additional ballast, the vessel would have been in compliance with the current international stability standards (as expressed in the 2008 IS Code) during the accident voyage and the previous two voyages. Although the weights and centers of gravity of the six compared loading conditions were not exact representations of the accident loading, taken together, they showed that the vessel required additional ballast as it was loaded at departure to meet the requirements found in the T&S Booklet and the 2008 IS Code. Therefore, the NTSB concludes that at departure from the Colonel's Island Terminal, the *Golden Ray* did not meet international stability standards and possessed less stability than the chief officer calculated.

2.2.3 Calculating Vessel Stability

The *Golden Ray*'s LOADCOM computer was removed from the vessel following the accident to review the chief officer's data input into the LOADCOM computer. However, the unit sustained extensive saltwater damage and could not be tested. Therefore, the vessel's loading condition (specific tank levels, cargo weights and locations, and draft) used by the chief officer in his LOADCOM computer stability calculations to determine the vessel's GM at departure and

whether the vessel met stability requirements are unknown. (For the MSC and other analyses, tank levels came from IMACS data and cargo weight and data from the final load plan.)

To recreate the *Golden Ray*'s stability condition at departure with a LOADCOM computer similar to the one the chief officer used, the charterer simulated the vessel's conditions on the LOADCOM computer of the *Silver Ray*, a vessel of the same class as the *Golden Ray*. The simulation showed that the GM of the *Golden Ray* was 1.8 meters (5.9 feet), which closely matched the postaccident stability studies completed by the NTSB, MSC, and KMST that showed the GM was significantly less than the 2.45 meters (8 feet) the chief officer reported. The simulation also showed that the LOADCOM computer indicated that the vessel did not meet stability standards by giving a status of "Not OK" on screen. If the chief officer had used the LOADCOM computer correctly and ensured all data entered were correct, it would have indicated that the vessel did not meet stability and heeling angle requirements and likely required additional ballast to do so.

Additionally, the vessel had a T&S Booklet that listed the minimum GM required to meet 2008 IS Code stability requirements for various examples of typical loading conditions; however, the chief officer gave no indication that he referenced the booklet when he calculated the vessel's stability. Postaccident analysis by the MSC showed that the stability information in the T&S Booklet was comparable to that which would be calculated by the LOADCOM computer.

The MSC generated and analyzed righting arm curves for the vessel's two previous voyages from Freeport, Texas, to Jacksonville, Florida, and from Jacksonville, Florida, to Brunswick, Georgia, and found that while the vessel had a slightly higher righting arm and righting energy during those voyages than during the accident voyage, the *Golden Ray* still did not meet the standards in the 2008 IS Code, thereby reducing its margin of stability. Because the vessel did not meet stability standards, it is likely that the chief officer also made errors in using the LOADCOM computer during the two previous voyages. The MSC determined that the vessel was not adequately ballasted during the accident voyage and the previous voyages, which is likely what led to the reduction in stability.

The chief officer told the NTSB that he oversaw operations and tank level soundings and personally observed and recorded the draft markings and entered them into the LOADCOM computer. Additionally, he chose to manually input the required data from the IMACS into the LOADCOM computer, rather than having the LOADCOM computer pull data from the IMACS. Because investigators were unable to interview the chief officer a second time, it is unknown why he chose to manually enter the data. The LOADCOM computer had the capability of automatically retrieving the vessel tank level and draft data from the IMACS and use that data, along with the cargo data entered by the chief officer, to determine the GM and overall stability of the vessel. The postaccident simulation showed that this functionality worked on the vessel of the same class, and a postaccident review of the *Golden Ray* IMACS data showed that the IMACS was functioning and there were no changes to the vessel's monitored systems before its capsizing.

In order to produce the GM reported by the chief officer for the accident voyage, an error would have had to have been made when inputting data into the system. There would have been minimal changes required for the inputs for the fuel, lube oil, fresh water, and other tanks before the *Golden Ray* departed Brunswick. Because the chief officer had just completed cargo operations, he was likely focused on cargo weights and locations, so the data he entered for cargo was likely accurate. The only other significant data he would have entered was ballast tank levels.

It is possible that the chief officer did not correctly account for the 1,492 MT of ballast that were removed before the vessel entered the previous port of Jacksonville, Florida. Further, the MSC found that during the previous two voyages, the vessel was not adequately ballasted. Therefore, the NTSB concludes that the chief officer made errors with the ballast tank level data entry into the shipboard stability calculation computer (LOADCOM), which led to his incorrect determination of the vessel's stability. The section below will discuss how this single-point failure could occur, what the operator is doing to ensure proficiency in the use of the LOADCOM computer, and what more can be done to prevent vessels from departing in an unstable condition.

2.3 Operator Oversight

2.3.1 Training

The chief officer had 13 years of experience at sea, 10 of which were working as a chief officer. To determine the vessel's stability, the chief officer could use the LOADCOM computer and/or the T&S Booklet. When the chief officer initially joined the crew of the *Golden Ray* about 6 months before the accident, he was given a few hours of on-the-job training by the former chief officer, including how to use the vessel's LOADCOM computer to calculate vessel stability. He had not previously used the LOADCOM computer, and G-Marine Service Co. Ltd., the operator, did not have a training program for using the LOADCOM computer. The operator's SMS outlined the chief officer's duties, which included calculating the vessel's stability; however, the SMS did not provide any instructions on how to use nor require demonstrated competency in the use of the LOADCOM computer. The chief officer did not use the LOADCOM computer's feature that automatically transferred IMACS data to the system, nor did he reference the vessel's T&S Booklet. Since the operator did not check the chief officer's knowledge of the stability calculation computer, nor did they provide training on how to use the computer, they had no means to verify that he was capable of performing his duty to accurately determine the ship's stability. The NTSB concludes that the operator did not have a method in place to ensure that the chief officer was proficient in using the shipboard stability calculation computer (LOADCOM) to perform his duty of calculating the ship's stability.

Given the impact that proficiency in using the vessel's stability computer had in the capsizing of the *Golden Ray*, after the accident, the operator increased the amount of training—including stability, calculation of draft, and use of the LOADCOM stability calculation computer—provided to chief officers hired by the company. In addition, the operator revised its procedures so that the GM provided by the LOADCOM computer must be compared with the minimum required GM in the T&S Booklet for a similar loading condition. The operator also required all masters and officers to receive refresher training for using the LOADCOM computer before boarding another vessel. Lastly, the operator is harmonizing its fleet to have similar stability computer systems on each vessel. These policies and procedures, if implemented appropriately, should result in officers having greater proficiency with onboard stability computing systems.

2.3.2 Audit Procedures

The chief officer was the crewmember on board the vessel in charge of calculating the vessel's stability, and he only used the LOADCOM computer to do so. While not required, he could have referenced the vessel's T&S Booklet to compare his LOADCOM-calculated GM with the booklet's requirements for a similar loading condition. Had he done so, he likely would have

noted that the vessel had too little ballast for the amount of cargo on board. The operator's SMS referenced the T&S Booklet but did not give specific guidance regarding how to use the booklet or instruct chief officers to compare the LOADCOM-calculated GM to similar conditions in the booklet.

After the chief officer had calculated the vessel's stability, he reported the final GM to the master. While the company SMS indicated that the master held final responsibility for the vessel, he did not verify the chief officer's calculations on the accident voyage or the previous two voyages, nor did he compare the chief officer's calculated GM to similar loading conditions in the T&S Booklet. The SMS did not require the master, another crewmember, or any other company personnel to verify the GM as calculated by the chief officer. Instead, the SMS only required the stability to be "OK condition" as calculated by the LOADCOM computer and "above the IMO required Min. GM for that condition."

The master regularly sent departure reports to the operator (with a stability section drafted by the chief officer), which included the vessel's GM and stability data, after the vessel departed a port. The departure reports for the vessel's previous two ports showed GMs different from what was calculated postaccident. Additionally, the vessel was found to lack the righting energy required to comply with the 2008 IS Code during both transits. However, neither the master nor the operator reported any issues with the chief officer's calculated GM, indicating that they likely were not verifying the chief officer's calculations for at least the previous few weeks before the capsizing and were unaware that the vessel had been sailing without meeting stability requirements.

In its 2018 review of US stability regulations, the TRB highlighted the risk of human error in determining vessel stability aboard Ro/Ro vehicle carriers. On large ocean-going vessels, such as Ro/Ro vehicle carriers, a master's duties traditionally include regular discussions with a vessel's chief officer regarding the vessel's tank levels, cargo, and taking an active role in verifying overall stability. The January 2020 amendment to *SOLAS* (which was not in effect at the time of the accident) enforces this idea and requires that the master of a cargo vessel should "determine the ship's trim and stability." However, the master had many responsibilities to get the vessel in and out of port, and the 5-hour turnaround time at Brunswick demanded focus and distribution of duties. In this case, the accident master had been on the vessel only 10 days and had not sailed on the *Golden Ray* or a vessel of the same class before. Further, with the small change in additional weight relative to total cargo loaded (a 4% increase in cargo weight and 2% increase in the number of vehicles on board), there may have been a lessened concern that stability would be an issue at sailing. Additionally, the operator's SMS did not require the master to verify the GM as calculated by the chief officer, and, as prescribed in the SMS, responsibility regarding the vessel's stability was assigned to the chief officer. Unless the master was aware of the location of or changes to the amount of ballast on board the vessel on each voyage, he would not have been able to detect the chief officer's error in stability calculations. If the master had taken a more active role in reviewing aspects of the vessel's stability (cargo loading, ballasting, fuels, and other tankage) and verifying the minimum stability requirements and the chief officer's stability calculations, he may have been able to identify the error. This practice—when only the chief officer was responsible for a safety-critical task without a backup to help identify possible errors—allowed a single point of failure to occur.

Further, the operator had no procedures to verify the chief officer's stability calculations once they were submitted, and they often were not submitted to the operator until after the vessel

was under way. Without any such procedures, there was no established means for the company to identify (and attempt to correct) the vessel sailing without meeting stability requirements from at least three ports (Freeport, Texas; Jacksonville, Florida; and Brunswick, Georgia), and the chief officer's errors went undetected. The NTSB concludes that the operator's lack of oversight and procedures for auditing and verifying the accuracy of their officers' vessel stability calculations before departure contributed to the *Golden Ray* not meeting international stability standards.

When properly implemented, an SMS is an effective tool to enhance safety for a company and its vessels. An SMS ensures standardized and unambiguous procedures for each crewmember during both routine and emergency operations. Duties and responsibilities are specified, and supervisory and subordinate chains of command are delineated. An SMS also requires procedures for the identification and correction of non-conformities and includes an audit process for management to ensure policies and procedures are being followed. Such procedures and processes would have assisted the operator in determining that the *Golden Ray* was sailing while not loaded and ballasted in a manner to meet stability standards due to the chief officer not correctly calculating the vessel's stability. With that knowledge, the operator could have then taken steps to ensure that the ship complied with the vessel's T&S Booklet—and therefore applicable stability standards—and that the chief officer was proficient with the LOADCOM computer. Therefore, the NTSB recommends that G-Marine Service Co. Ltd. revise its safety management system to establish procedures for verifying stability calculations and implement audit procedures to ensure their vessels meet stability requirements before leaving port.

2.4 Flooding

To secure the vessel for a voyage, the company's Arrival/Departure Checklist required all watertight doors to be closed and all hull openings to be secure and watertight. The *Golden Ray*'s portside pilot door (side port) had been opened during the accident voyage in preparation for the pilot's departure outside of the port, which was normal procedure. In addition, according to the IMACS data, two watertight doors to portside stairwells on deck 5 were open at the time of the heeling: one located about 75 feet (22.9 meters) aft of the open pilot door that went down to the forward part of the engine room and served as the primary engine control room and engine room access, and one at the stern that served the steering gear room. As the vessel heeled to port past 17°, the open portside pilot door on deck 5 was immersed and allowed water to enter deck 5 and flow freely along the port side (low side) of the vessel as it quickly heeled to a 60° angle. Water then entered the open watertight doors to both stairwells, where engineering crewmembers were attempting to exit the engine room and engine control room. The NTSB concludes that after the *Golden Ray* heeled, open watertight doors on deck 5 allowed flooding into the vessel and blocked the primary egress from the engine room. The flooding in the stairwells also entered the engine room and the steering gear room, flooding both until the level inside the spaces reached the vessel's waterline as it settled.

Leaving the two watertight doors to the stairwells open on the accident transit contradicted the operator's Arrival/Departure Checklist in the SMS guidance. The watertight door indicator panel on the bridge would have indicated with red lights that the doors were open, and any crewmembers on the bridge would have been able to readily check the status of the doors. According to the IMACS data, the two watertight doors had been left open for almost 2 hours before the accident. However, no one on the bridge ensured that the doors were closed before departure from the port. The circumstances of this accident show that even when transiting in

protected waters, watertight integrity is critical to the safety of the vessel and its crew, and it is essential that the operator ensure that crews verify that all watertight doors are closed in accordance with SMS procedures. Therefore, the NTSB recommends that G-Marine Service Co. Ltd. revise its safety management system audit process to verify crew adherence to the Arrival/Departure Checklist regarding the closure of watertight doors.

3. Conclusions

3.1 Findings

1. None of the following safety issues were identified for the accident transit: (1) weather; (2) a transfer of ballast or fuel; (3) the propulsion and steering systems; (4) the shifting of cargo within the vessel; (5) obstructions in the channel that could have caused the vessel to ground; or (6) the cargo hold fire.
2. The *Golden Ray* capsized because it did not possess enough righting energy to counter the port heeling moment created during the attempted execution of the 68° starboard turn at widener 11.
3. At departure from the Colonel's Island Terminal, the *Golden Ray* did not meet international stability standards and possessed less stability than the chief officer calculated.
4. The chief officer made errors with the ballast tank level data entry into the shipboard stability calculation computer (LOADCOM), which led to his incorrect determination of the vessel's stability.
5. The operator did not have a method in place to ensure that the chief officer was proficient in using the shipboard stability calculation computer (LOADCOM) to perform his duty of calculating the ship's stability.
6. The operator's lack of oversight and procedures for auditing and verifying the accuracy of their officers' vessel stability calculations before departure contributed to the *Golden Ray* not meeting international stability standards.
7. After the *Golden Ray* heeled, open watertight doors on deck 5 allowed flooding into the vessel and blocked the primary egress from the engine room.

3.2 Probable Cause

The National Transportation Safety Board determines that the probable cause of the capsizing of the *Golden Ray* was the chief officer's error entering ballast quantities into the stability calculation program, which led to his incorrect determination of the vessel's stability and resulted in the *Golden Ray* having an insufficient righting arm to counteract the forces developed during a turn while transiting outbound from the Port of Brunswick through St. Simons Sound. Contributing to the accident was G-Marine Service Co. Ltd.'s lack of effective procedures in their safety management system for verifying stability calculations.

4. Recommendations

4.1 New Recommendations

As a result of its investigation of this accident, the National Transportation Safety Board makes the following two new safety recommendations:

To G-Marine Service Co. Ltd.:

Revise your safety management system to establish procedures for verifying stability calculations and implement audit procedures to ensure your vessels meet stability requirements before leaving port. (M-21-012)

Revise your safety management system audit process to verify crew adherence to the Arrival/Departure Checklist regarding the closure of watertight doors. (M-21-013)

BY THE NATIONAL TRANSPORTATION SAFETY BOARD

JENNIFER HOMENDY
Chair

MICHAEL GRAHAM
Member

BRUCE LANDSBERG
Vice Chairman

THOMAS CHAPMAN
Member

Adopted: August 26, 2021

5. Appendixes

Appendix A: Investigation

The National Transportation Safety Board (NTSB) was notified of this accident on September 8, 2019, and members of the investigative team arrived on scene the following day. Investigative groups were formed to evaluate operations, human performance, vessel seaworthiness, and vessel systems.

In accordance with the International Maritime Organization Casualty Investigation Code, this investigation was mutually agreed upon to be a coordinated effort between the Republic of the Marshall Islands (the *Golden Ray*'s flag state), the NTSB, the Korea Maritime Safety Tribunal, and the US Coast Guard. Parties of interest to the Coast Guard investigation included the Brunswick Bar Pilots Association, Hyundai Glovis Co. Ltd., and G-Marine Service Co. Ltd. The Republic of the Marshall Islands, Brunswick Bar Pilots Association, and Korea Maritime Safety Tribunal were named parties to the NTSB investigation. Hyundai Glovis Co. Ltd. and G-Marine Service Co. Ltd. declined to be parties to the NTSB investigation.

The NTSB did not participate in the salvage of the *Golden Ray*. As of the publication of this report, salvage efforts are still under way. Therefore, this report does not incorporate any details or information that may have been or could be found during salvage.

Appendix B: Consolidated Recommendation Information

Title 49 *United States Code (USC)* 1117(b) requires the following information on the recommendations in this report.

For each recommendation—

(1) a brief summary of the Board's collection and analysis of the specific accident investigation information most relevant to the recommendation;

(2) a description of the Board's use of external information, including studies, reports, and experts, other than the findings of a specific accident investigation, if any were used to inform or support the recommendation, including a brief summary of the specific safety benefits and other effects identified by each study, report, or expert; and

(3) a brief summary of any examples of actions taken by regulated entities before the publication of the safety recommendation, to the extent such actions are known to the Board, that were consistent with the recommendation.

To G-Marine Service Co. Ltd.

M-20-012

Revise your safety management system to establish procedures for verifying stability calculations and implement audit procedures to ensure their vessels meet stability requirements before leaving the port.

Information that addresses the requirements of 49 *USC* 1117(b), as applicable, can be found in section [2.3 Operator Oversight](#). Information supporting (b)(1) can be found on pages 36–38; (b)(2) is not applicable; information supporting (b)(3) can be found on pages 29–30.

M-20-013

Revise your safety management system audit process to verify crew adherence to the Arrival/Departure Checklist regarding the closure of watertight doors.

Information that addresses the requirements of 49 *USC* 1117(b), as applicable, can be found in section [2.4 Flooding](#). Information supporting (b)(1) can be found on pages 38–39; (b)(2) and (b)(3) are not applicable.

Appendix C: Principles of Stability

Ship stability reflects the relationship between buoyancy (the force pushing on a ship allowing it to float) and gravity (the force pushing the ship into the water). Gravity acts on all parts of the ship's structure, equipment, cargo, and personnel. The force of gravity acts downward through the ship's center of gravity (G), while the buoyant force acts upward through the ship's center of buoyancy (B). When a vessel is floating at an even keel or upright, the force of gravity and buoyancy are vertically aligned. The properties of stability are usually expressed as the magnitude of a heeling moment necessary to incline the vessel to a certain angle, the angle a vessel may heel to before capsizing, and other parameters that can be calculated.

When a disturbing force such as wave action or wind pressure exerts an inclining moment on a ship, the ship's underwater volume shifts in the direction of the heel, which causes the center of buoyancy to shift in the same direction. Stability is the tendency of a vessel to return to its original upright position when the force (e.g., wind or wave) is removed (see figure C-1). The shift does not affect the position of the ship's center of gravity, unless cargo, equipment, or water (weights) are free to move. As a result, the lines of action of the forces of buoyancy and gravity separate and exert a moment on the ship that tends to restore the ship to an even keel. That is known as a righting moment.

The righting moment is the product of the force of buoyancy times the distance that separates the forces of buoyancy and gravity. That distance is known as the ship's righting arm. The righting arm can be expressed as a curve plotted at successive angles of heel. The length of the righting arm generally increases with the angle of heel to a maximum point, after which it decreases, reaching zero at a very large angle of heel. A reduction in the size of the righting arm usually means a decrease in stability. The area under the righting arm curve represents the energy available to the ship to right itself, and in general, the more

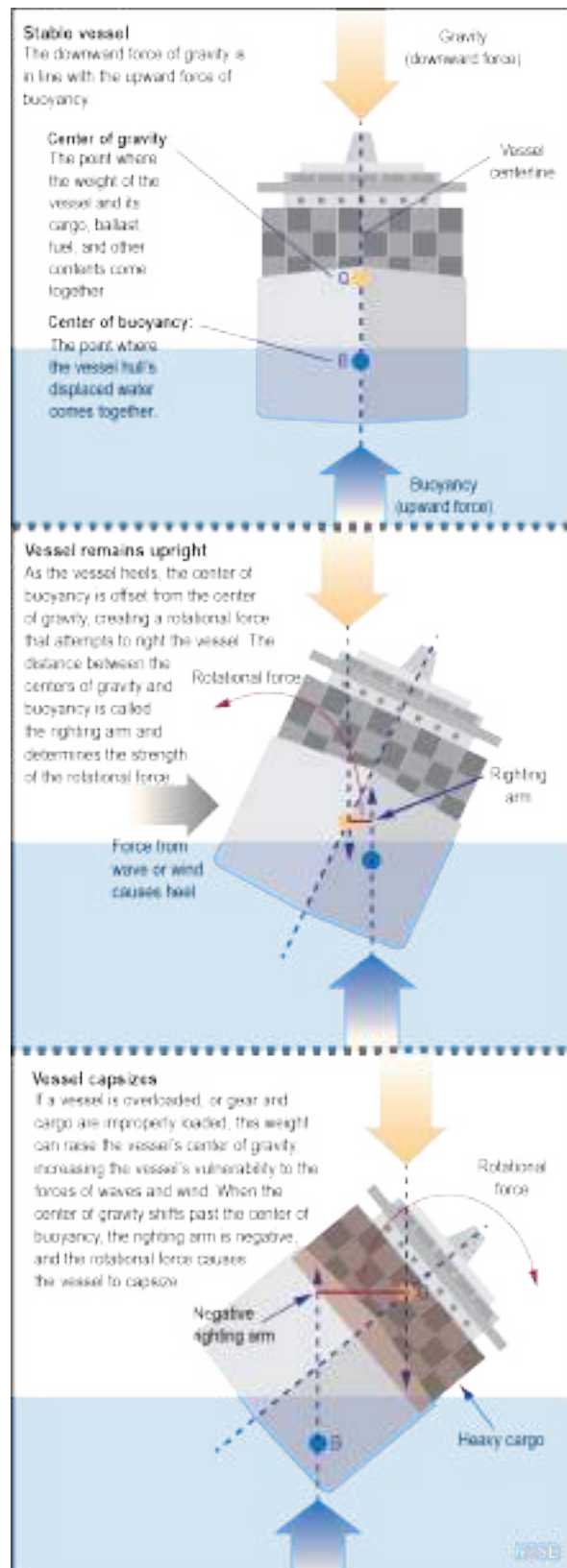

Figure C-1. Forces that make a vessel stable or likely to capsize.

area under the curve, the larger the capsizing moments the vessel can resist. The angle where the righting arm crosses zero denotes where a vessel's stability changes from positive righting moments to negative capsizing moments. Vessels are often termed "stable" when they have enough positive stability to return to an upright position in the conditions encountered as loaded, and "unstable" when they do not, and capsize.

A ship's metacenter (M) is the virtual intersection of two successive lines of action of the force of buoyancy when the ship heels through a very small angle. The initial position of the metacenter is used as a reference in stability calculations. The distance from a ship's center of gravity (G) to its metacenter is known as the GM, which measures the vessel's ability to right itself when experiencing an overturning moment. The mathematical relationship between the righting arm and the metacentric height makes GM a measure of the initial slope of the righting arm curve and an indication of whether the ship is stable or unstable at small angles of heel.

Intact stability refers to how an intact, or undamaged, vessel will respond when heeled over in calm conditions. The specific stability characteristics of a vessel are calculated based on the model of its hull form (hydrostatics), developed from plans and lightship characteristics stability (which are determined through an inclining experiment in which precise measurements are taken on board the vessel to determine its displacement and center of gravity). Stability analysis generally requires the services of a naval architect.

Appendix D: Golden Ray Water Ballast Tanks

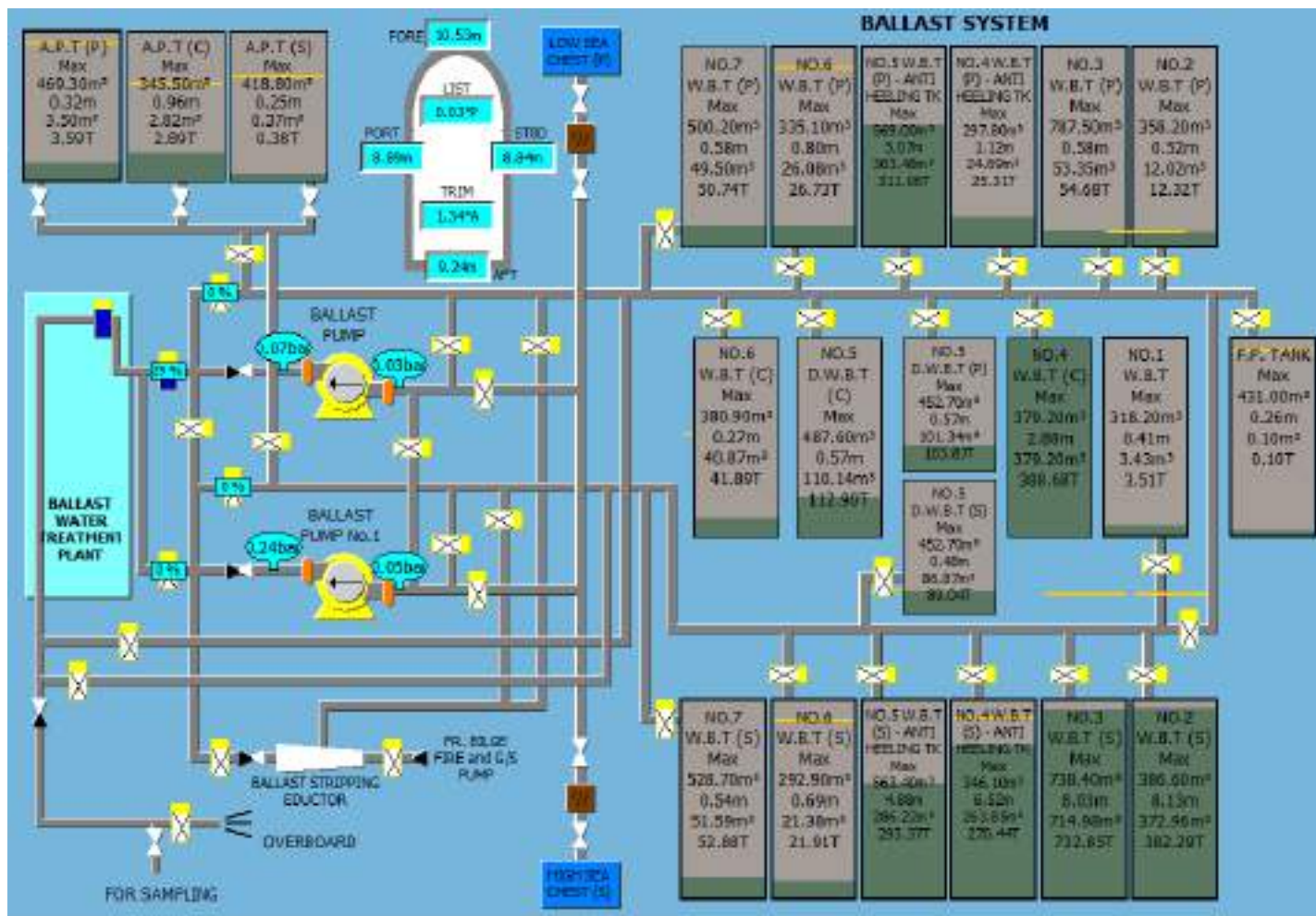

Figure D-1. IMACS water ballast system data before the *Golden Ray's* departure from the Colonel's Island Terminal.

References

Hyundai Glovis Co. Ltd. "SILVER RAY – Full stress and stability report." May 12, 2020.

National Academies of Sciences, Engineering, and Medicine. *Review of U.S. Coast Guard Vessel Stability Regulations*. Washington, DC: National Academies Press, 2018. <https://doi.org/10.17226/25258>.

US Coast Guard Marine Safety Center. "Technical Report: *Golden Ray* Intact Stability, August 26, 2020."