

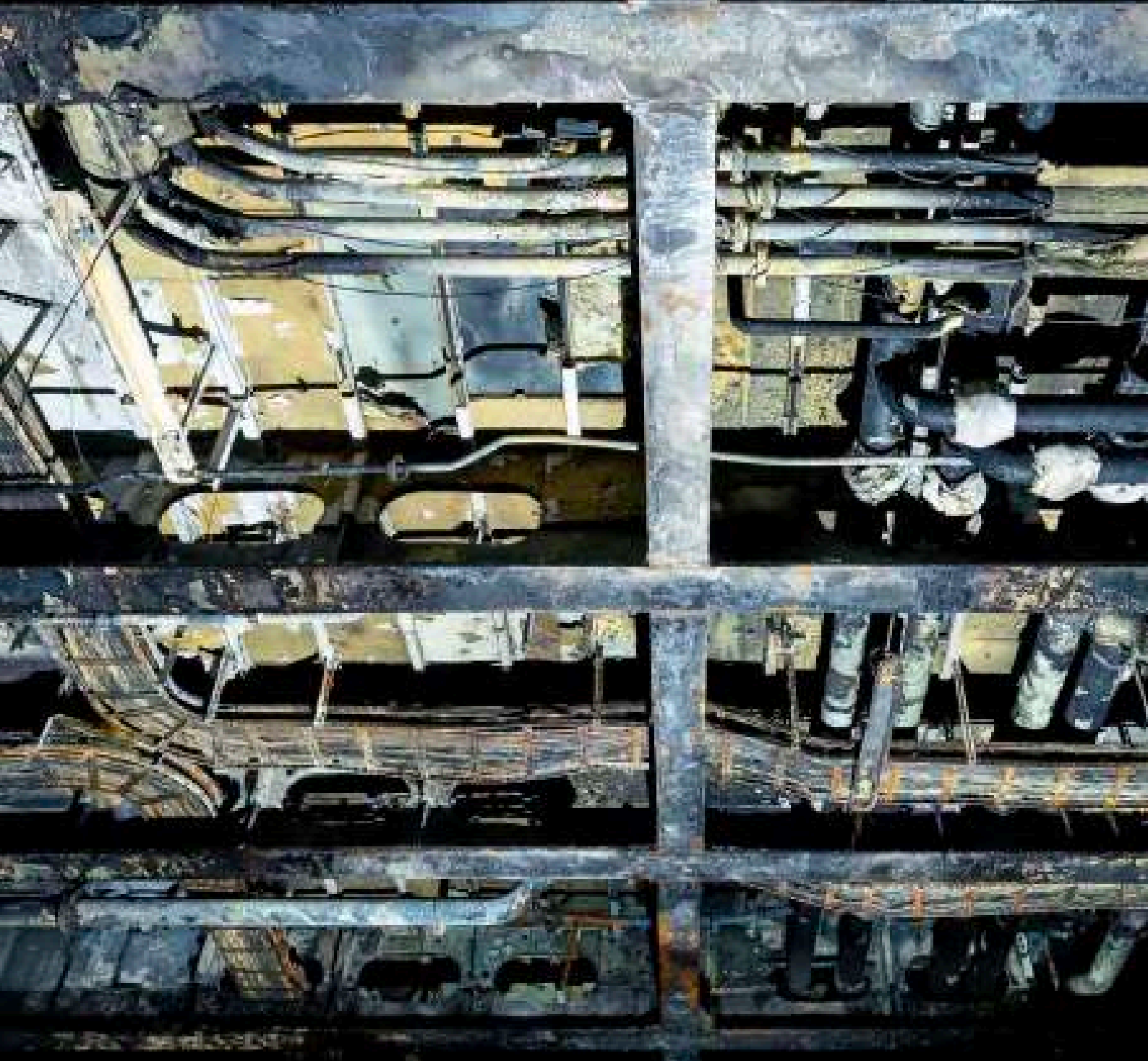

# DMAIB

DANISH MARITIME ACCIDENT  
INVESTIGATION BOARD



# STENA SCANDICA

Marine accident report on fire

29 AUGUST 2022

**MARINE ACCIDENT REPORT ON FIRE ON BOARD STENA SCANDICA  
ON 29 AUGUST 2023**

published by

DMAIB  
Danish Maritime Accident Investigation Board  
Batterivej 9  
DK-4220 Korsoer  
Denmark

The report is issued on 4 September 2023.

Photo: Fire damaged deckhead and cables on Deck 4.  
Source: DMAIB

The report may be reused in any format or medium. You must reuse it accurately and not in a misleading context. You must give the title of the source publication.

Where we have identified any third party copyright material you will need to obtain permission from the copyright holders concerned.

The investigations are carried out separately from the criminal investigation, without having used legal evidence procedures and with no other basic aim than learning about accidents with the purpose of gaining and promoting an understanding of safety. Consequently, any use of this report for other purposes may lead to erroneous or misleading interpretations.

# Content

---

Introduction .....	4
<b>NARRATIVE .....</b>	<b>6</b>
Background .....	7
Fire .....	8
Blackouts .....	14
<b>INVESTIGATION OF FIRE .....</b>	<b>18</b>
Fire scene .....	19
Origin of the fire .....	21
Source of ignition .....	27
Fire spread .....	30
Firefighting .....	34
Key points of the fire investigation .....	35
<b>INVESTIGATION OF BLACKOUT .....</b>	<b>36</b>
Statutory requirements for electrical power supply on Danish passenger ships .....	37
Electrical power supply system on STENA SCANDICA .....	39
Cable layout .....	42
Electrical system failure .....	43
Restoration of power .....	48
Key points of the blackout investigation .....	56
<b>INVESTIGATION OF EVACUATION .....</b>	<b>57</b>
On-board evacuation system .....	58
Decision to evacuate by onboard evacuation system .....	64
Key points for evacuation investigation .....	67
<b>ANALYSIS .....</b>	<b>68</b>
The fire on Deck 4 .....	69
Vulnerabilities in electrical infrastructure .....	69
Troubleshooting and crisis management .....	70
<b>CONCLUSION .....</b>	<b>72</b>
Accident causation .....	73
Learning from the accident .....	74
<b>PREVENTIVE MEASURES .....</b>	<b>75</b>
Preventive measures by Stena Rederi A/S .....	76
<b>APPENDIX .....</b>	<b>77</b>

# Introduction

---

## Investigation

On 29 August 2022, DMAIB was informed that a fire had broken out on the Danish Ro-Ro passenger ship STENA SCANDICA while en route from Nynäshamn, Sweden, to Ventspils, Latvia. The fire was under control, but the ship's power supply system had failed, and the ship was drifting towards the Swedish island of Fårö.

Firefighters from shore had been deployed by JRCC Sweden to assist the crew, and rescue boats and helicopters were on standby in the area. In the early evening, it was decided that families with children and elderly people were to be evacuated. The remaining passengers were to stay on board for as long as possible, as this was deemed safer than boarding the ship's lifeboats and rafts. At 1900, the evacuation of passengers by helicopter was commenced. While the helicopter transfers were ongoing, the ship's crew managed to restore propulsion and steering, and the ship was able to return to Nynäshamn.

DMAIB immediately launched an investigation due to the seriousness of the events. Three investigators were deployed to Sweden, where the investigators boarded the ship upon its arrival. In the following three days the investigators collected evidence. DMAIB investigators revisited the ship in December 2022 to carry out additional investigations.

The purpose of the investigation was to:

- Establish the course of the events;
- Determine the cause of the fire;
- Clarify the circumstances of the power supply failure;
- Establish the decision-making concerning the evacuation of passengers.

## Report

The investigation report presents the evidence that DMAIB collected during the investigation and that DMAIB considers relevant for understanding the conditions of the accident. The investigation is based on various types of data from various sources, comprising witness accounts, photo documentation, VDR recordings, AIS data, technical drawings and diagrams, internal technical reports, alarm logs, SAR reports, CCTV footage, shipboard procedures and equipment manuals.

This report consists of three main sections:

- **Narrative:** The narrative aims to present the course of events as they were experienced by the key persons involved on STENA SCANDICA and the knowledge they had as the events unfolded. Presenting the course of events from the perspective of the persons involved is essential for understanding the context and circumstances for troubleshooting and decision-making during critical situations.

- **Investigation:** The investigation is sub-divided into three sections:
  - *Fire:* The fire investigation aims to determine the cause and development of the fire through an assessment of the damage, as well as reviewing the on-board firefighting systems and response.
  - *Power supply failure:* The investigation into the power supply failure examines the design of the power supply system on board, the faults experienced following the fire, and the resulting troubleshooting and actions taken to restore power.
  - *Evacuation:* The investigation into the evacuation of passengers looks into the factors influencing the decision-making process regarding when and how passengers were to be evacuated, and includes detailed descriptions of the methods available.

The three sub-sections also describe how safety-critical systems are designed to function, and how the systems performed in an actual safety-critical situation.

- **Analysis and conclusion:** In these sections, DMAIB combines the factors and issues identified to explain how a fire on the vehicle deck could lead to the ship drifting uncontrollably towards the coast, necessitating the need to start evacuating passengers. By describing the problems that emerged after the fire started, the vulnerabilities within the ship's systems become apparent.

The final sections include the safety learning stemming from the analysis and conclusions, and the preventative actions taken.

# Narrative

## Reconstruction of course of events

The narrative aims to present a reconstruction of the course of events as they were experienced by the persons involved on board STENA SCANDICA. The narrative is based on witness accounts supported by data recorded on VDR, CCTV and AIS, and in SAR reports, and logs written on the ship and by the Stena Lines emergency group.

All times are stated in the ship's local time during the accident: UTC+2.

## Background

At the time of the accident, STENA SCANDICA (Figure 1 and Appendix p. 77) was a Ro-Ro passenger ship owned by Kollsholmens Shipping AB, was in a bareboat charter to Stena Rederi A/S, and was operated by Stena Marine Management ApS.

The ship was built in 2005 and converted in 2020, when the ship's length was extended to accommodate more passengers and vehicles. After the conversion, the ship had a capacity of 922 passengers. The capacity of vehicles depended on the composition of vehicle types on board. STENA SCANDICA had been registered in Denmark since 2021.

STENA SCANDICA was engaged in a fixed route with daily voyages between Nynäshamn, Sweden, and Ventspils, Latvia. On 29 August 2022, the ship departed Nynäshamn as planned at 0900 and was scheduled to arrive in Ventspils 8.5 hours later. On this voyage, STENA SCANDICA was manned by 58 crewmembers of Baltic nationalities and carried 241 passengers of mixed nationalities.



Figure 1: STENA SCANDICA  
Source: Stena Rederi A/S

# Fire

29 August 2022

1200

At 1200 on 29 August 2022, the safety officer<sup>1</sup> came to the bridge on STENA SCANDICA to take over the watch as planned. Shortly after the safety officer had relieved the previous officer on watch, the second officer came to the bridge to take a cup of coffee and keep the safety officer company, as he usually did after having lunch. The ship was about to pass south of the Swedish island Gotska Sandön and was heading 140° to follow the planned route, at 16 knots. The wind was a moderate north-easterly gale, and the sea state was moderate with 2-3 m waves (Figure 2).



Figure 2: STENA SCANDICA's position at 1200.  
Source: SafeSeaNet Ecosystem GUI, modified by DMAIB

1215

At 1215, while the two officers talked, an alarm sounded on the fire alarm panel. Both officers went to the panel to identify the source of the alarm, and quickly saw that it was on vehicle Deck 4. The safety officer called the ordinary seaman (OS) on watch on the UHF radio and ordered him to check for fire on Deck 4 (Figure 3).

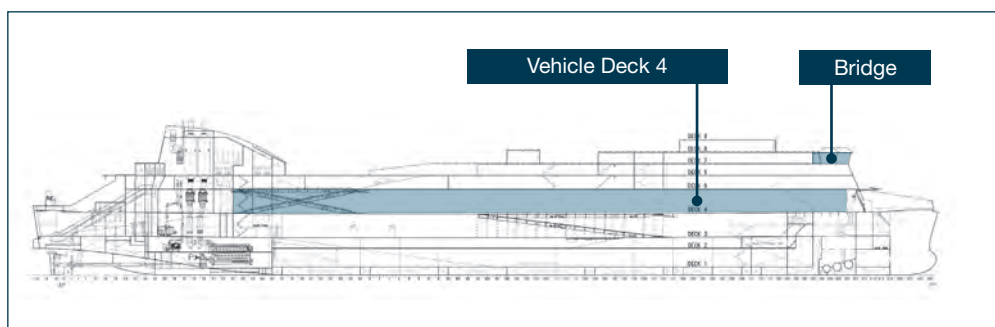

Figure 3: Location of Deck 4 in relation to the bridge.  
Source: Stena Rederi A/S, modified by DMAIB

1 2<sup>nd</sup> officer with responsibility for safety equipment on STENA SCANDICA.



The chief officer was working in his cabin with his UHF radio open and overheard the message. He rushed to the bridge and immediately checked the CCTV monitors covering Deck 4. The chief officer saw smoke and ordered for the general alarm to be raised and ran to the fire station, as he was the fire team leader.

The general alarm sounded at 1218. All crewmembers hurried to their designated muster stations: the command team mustered on the bridge; two fire teams mustered at their designated fire lockers; the catering personnel mustered at the reception on Deck 5; and the engine team mustered in the engine control room. The master was in his office close to the bridge when the general alarm sounded, and he rushed to the bridge and took charge of the situation. He quickly assessed the situation using the CCTV monitors and looking from the bridge wing. The monitors showed that the vehicle deck was filled with smoke, which the master also saw coming from the openings in the ship side on Deck 4 (Figure 4).



*Figure 4: Still from CCTV recording on Deck 4 at 1219.  
Source: STENA SCANDICA*

Simultaneously, the watchkeeping OS, who had been sent to Deck 4, yelled on the radio that he could see flames. The master immediately ordered for the drenchers to be activated. He also ordered a speed reduction and a heading change to try use the wind to clear the smoke and optimize the conditions for the firefighters.

In the engine control room on Deck 3, the engine team and the electro technical officer (ETO) were busy isolating the electrical power on Deck 4 to protect the firefighters from electric shocks. All reefer sockets on Deck 4 were isolated, and all breakers on the main switchboard for electrical services deemed unnecessary on the forward part of the ship were opened. The engine team knew that cables supplying most electrical services on the forward part from the main switchboard were led across Deck 4. Power was maintained on all equipment and services necessary for manoeuvring the ship.

1222 ○

At 1222, the bridge crew noticed that the GPS had stopped updating the ship's position. The master ordered one of the navigational officers to switch to the secondary GPS.

Shortly after, the secondary GPS also failed to update, and the crew also noticed that other navigational instruments, such as AIS and the S-band radar, had begun to fail or shut down. The master announced on the public address system that all passengers were to assemble at the muster station on Deck 5. The master was then informed that smoke was starting to become noticeable in the accommodation, where the catering personnel were already gathering the passengers at the designated muster station on Deck 5 (Figure 5).

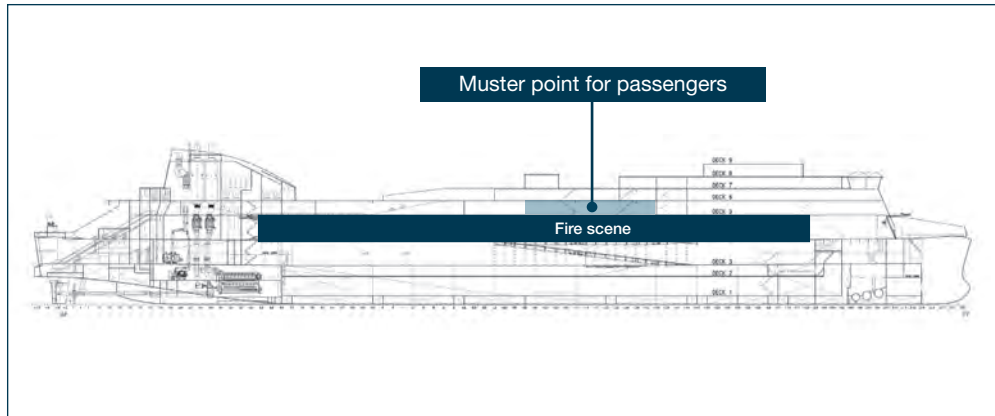

Figure 5: Location of passenger muster point on Deck 5.  
Source: Stena Rederi A/S, modified by DMAIB

1223

By 1223, the fire teams had collected their equipment from their fire locker and the appointed firefighters had donned their suits and breathing apparatuses and now rushed to the fire scene (Figure 6). When entering Deck 4, the chief officer observed heavy smoke and flames on the forward part of the vehicle deck and that the drenchers were not running. He rushed to the drencher room on Deck 3, opened drenchers in the four forward sections and then headed back to Deck 4.



Figure 6: Fire team running on Deck 5 on their way to Deck 4.  
Source: STENA SCANDICA

1226

At 1226, the master was informed that the entire passenger area was now affected by smoke, so he decided that the passengers were to be transferred to the sun deck on Deck 7.

On the sun deck, the crew counted the passengers and confirmed the number corresponded to the number of persons on the passenger list, and therefore it was not necessary to search the cabins. All the passengers had donned life jackets.

1229 ○

At 1229, the chief officer reached Deck 4 and called the master to say that the drenchers were running. The fire teams connected hoses to the fire hydrants, and firefighters entered the smoke-filled area of Deck 4 to locate the fire. The smoke was dense, and it was pitch black with no visibility, so the first firefighter team took the hose and kept in physical contact with the starboard bulkhead and with each other to avoid getting lost. When the firefighters received a signal of low air supply, they left the hose on the deck and used it as a guideline to find their way out of the smoke. The next firefighter team then followed the hose into the smoke, carried the hose a little further in the search for the fire until they had to return due to low air supply and be relieved by the next firefighter team. The next firefighter team repeated the process. The fire teams tried to keep contact with the bridge, but communication was made difficult due to the weak signal on the handheld UHF radios. It was therefore difficult for the bridge team to get an exact overview of the situation at the fire scene.

On the bridge, the crew began to suspect that the controls for rudder and pitch might have failed, and they tried to determine whether or not the ship was responding to the orders given by the helm and manoeuvring handles. The master contacted the company and informed them about the fire: that the ship had lost directional control, the GPSs had failed and the ship's position was unknown in relation to Gotska Sandön. At 1234, two crewmembers were ordered to the emergency steering room on the aft part of the ship, and the engine controls were operated by the engine crew on the orders from the master. At this point, the intercom had failed and the crew had to communicate via the sound-powered emergency phone. The bridge crew was frustrated at not knowing the cause of the malfunctioning navigational equipment. Meanwhile they had to focus on mustering the passengers, the progress of the firefighting, communication with rescue services and trying to establish the ship's position.

1234 ○

After several attempts to contact JRCC Sweden (Swedish Rescue) on VHF channel 16, the ship issued MAYDAY as a DSC distress alert. At 1238, the Swedish Rescue responded. The second officer informed them that the ship had a fire on board and that the crew was making efforts to fight the fire. Furthermore, he informed them that the ship was drifting. Swedish Rescue replied that they would deploy rescue units to the area.

1238 ○

At 1245, the master ordered minimum ahead on the engines while they tried to establish emergency steering. Due to the impact from wind and sea and the ship making slow speed, the ship was now effectively drifting. At the last position that the master had seen on the ECDIS before the GPS and AIS failed, the ship was approximately 6 nm from Gotska Sandön, and more than 20 minutes had passed since then. He was worried that the ship might drift towards the island, and he requested a deck officer try to establish the ship's position (Figure 7).

1245 ○

To reduce the drift, the master ordered the bosun to the forecastle to release the anchors. Other crewmembers had made an attempt to approach the forecastle earlier, but the staircase leading to the forecastle was filled with smoke and was not accessible without breathing apparatus. As the bosun was part of the firefighter team, he was equipped to enter the forecastle. However, the bosun did not hear the order as he was busy firefighting.



Figure 7: STENA SCANDICA's position at 1220.  
Source: SafeSeaNet Ecosystem GUI, modified by DMAIB

Meanwhile, the firefighters located a truck enveloped in flames on the forward part of Deck 4, and started to spray directly on to the vehicle. They also connected additional hoses to intensify the firefighting. The burning truck was quickly extinguished, and the firefighters continued to cool the area. In the meantime, other crew members had observed rising surface temperatures in the passenger areas above the fire scene, and boundary cooling was initiated on Deck 5.

1256 ○ At 1256, the master informed Swedish Rescue that the fire was under control and assistance from external firefighters was not needed. Swedish Rescue decided to continue their operation, with rescue boats, coastguard ships and helicopters heading towards STENA SCANDICA.

1259 ○ At 1259, the master gave the order to reduce the number of active drencher sections. The chief officer went to the drencher room and closed all drencher sections apart from the two forward sections.

1311 ○ At 1311, the chief engineer informed the master that a drencher pipe had perforated and was leaking. The drencher pipe was located above one of the main engines and had to be repaired to avoid damage to the main engine. The master got the impression that the drenchers was stopped while repair was ongoing and thought they were now without drenchers. However, in the engine room the engine team worked on sealing off the pipe while the drencher system was pressurised.

Meanwhile, the chief engineer noticed an indicator lamp on the main switchboard cabinet showing that the ship's UPS batteries for the 24V power supply were discharging. He knew that the 24V UPS batteries would only discharge when there was no voltage on the emergency switchboard. However, another indicator lamp signalled that the ship's emergency generator was running and therefore should be supplying the emergency switchboard. The 24V power supply was essential for all machinery and equipment on the ship, and the chief engineer knew that the ship would suffer a blackout<sup>2</sup> if the 24V power supply was lost. He also knew that the time available to identify why the 24V UPS batteries were discharging was limited, and he wanted to buy more time by shutting down the engines to reduce the load on the batteries.

<sup>2</sup> Blackout is used synonymously with dead ship condition: the condition under which the main propulsion plant, boilers and auxiliaries are not in operation due to the absence of power.

1314 ○

At 1314, he called the master and asked whether it was possible to stop the engines. The master responded that it was not possible and that they had to drop the anchors to stop the ship from drifting ashore. Meanwhile, the ETO rushed to the emergency generator room on the forward part of the ship on Deck 8 to investigate the problem (Figure 8).

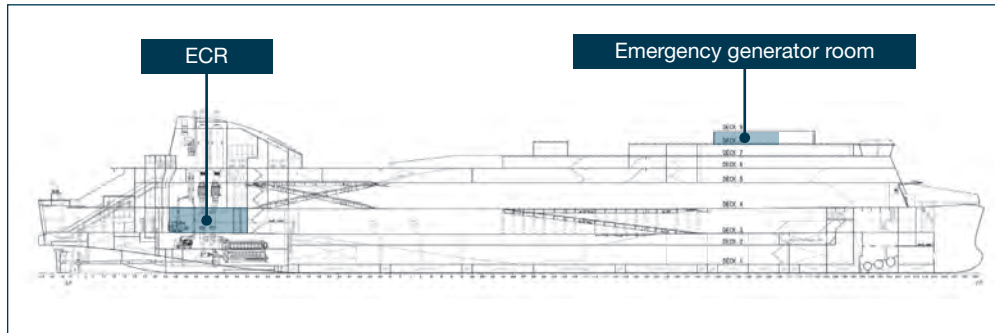

Figure 8: Location of engine control room and emergency generator room.  
Source: Stena Rederi A/S, modified by DMAIB

1316 ○

At 1316, the master repeated his order for the bosun to go to the forecandle to release the anchors. This time, the bosun heard the message and immediately left the fire scene on Deck 4 and headed to the forecandle. At 1323, the bosun was in position and he was ordered to lower the port side anchor to two shackles.

1324 ○

At 1324, the master received information that the engine team had managed to seal the leaking pipe above the main engine with jackets and belts (Figure 9).



Figure 9: Sealed off drencher pipe leakage.  
Source: DMAIB

Meanwhile, the ETO had reached the emergency generator room on Deck 8. He observed that the emergency generator was running, but the breaker connecting the emergency generator to the emergency switchboard had not closed as it was supposed to and was therefore not supplying the emergency switchboard. This explained why the 24V UPS batteries were discharging. The ETO made several attempts to close the breaker, but each time the breaker tripped. While operating the breaker, he was informed on the UHF radio that sparks were coming from the cables on the deckhead on Deck 4. He rushed back to the ECR to isolate additional services and to discuss the issue of the tripping breaker with the chief engineer.

## Blackouts

---

1331 ○

At 1331, the master informed the company that the fire had been extinguished, and he assessed that it was possible for the ship to continue passage at low speed if they could regain control of the steering and engines. One minute later, the fire team called the bridge to inform that the drenchers had suddenly stopped. Seconds later, the crew in the emergency steering gear room advised that the lights had gone out. At the same time, many alarms sounded on the bridge. At 1332, the master concluded that the ship was suffering a blackout. The ship was now drifting uncontrollably. The master immediately requested the status of the anchors. The bosun replied that the winch had stopped working while he was lowering the port anchor, and now it was stuck with only half a shackle in the water. The bosun was ordered to slowly lower the starboard anchor.

The fire teams on Deck 4 started to lose water pressure in the hoses, and they decided to collect all portable fire extinguishers and assemble them near the fire scene. There was no smoke or fire, but there was still heat in the area.

The chief engineer and the ETO tried to work out how they could restore power in the engine room without power from the emergency switchboard. They had realised that all cables connecting the emergency switchboard to services and equipment in the engine room ran across the fire area on Deck 4 and had been damaged. Consequently, they decided to jump-start the main generator using batteries. They went to the battery room on Deck 8 and disconnected the batteries for the GMDSS, which was the only option. When the batteries were connected to the generator, the chief engineer and the ETO realised that the generator also required air pressure to start. The only way to get air pressure was to restore power to the ship's emergency compressor, which was supplied by the emergency switchboard. Therefore, the ETO had to return to the emergency generator room and resolve the problem with the tripping breaker.

On the forecastle, the bosun had paid out six shackles on the starboard anchor, but vibrations on the anchor chain had caused a stopper on the winch to fall and block the chain on the windlass. The water depth was approximately 70 m, and the length of the anchor chain in the water was approximately 165 m.

- 1359 ○ At 1359, the master informed the company that the ship had no power, that the anchors were stuck on the winches and that he was unsure whether the starboard anchor was holding the ship in position. They still did not have any navigational equipment available to determine their position, other than taking bearings visually and trying to plot positions on a paper chart. He requested assistance from external firefighters, as they did not have any fire pumps to provide water for firefighting. The company began to arrange a tugboat to tow the ship back to Nynäshamn if necessary.
- 1420 ○ At 1420, the master concluded that the anchor was dragging, and he assessed that the ship was drifting at 2.5 knots in a southerly direction.
- The accommodation had been cleared from smoke, so the master decided that it was safe to transfer the passengers to the first muster station in the passenger area on Deck 5 to make the situation more comfortable for them. The passengers were still required to wear life jackets.
- In the emergency generator room, the ETO discovered that a protection mechanism on the breaker connecting the emergency generator to the emergency switchboard was activated and was making the breaker trip. He tried to reset the protection unit several times, but it kept tripping even though the emergency switchboard was isolated from all equipment and services which could trigger the protection unit. He therefore reckoned that there had to be a fault signal within the system, and he decided to disengage the protection unit.
- 1500 ○ At 1500, the ETO managed to connect the emergency generator to the emergency switchboard. Hoping that the cable for the emergency compressor was undamaged by the fire, the ETO closed the breaker providing the power supply to the emergency compressor. No short circuit occurred, and the compressor now started to build air pressure. The ETO also discovered that one cable for the 24V power supply from the emergency switchboard to the engine room services was partly working.
- At about the same time, a helicopter arrived with four firefighters. The helicopter had limited capacity and would return with more firefighters later. The firefighters did not bring fire-extinguishing equipment with them. So, the ship's portable fire extinguishers were the only available means of fighting the fire if it reignited. The master was informed by the company that a tugboat was underway with an ETA at STENA SCANDICA of between 1800 and 1900.
- 1545 ○ At 1545, the bridge team established that the ship was drifting south towards the island of Fårö at 2.5 knots (Figure 10).
- 1634 ○ At 1634, the tugboat's ETA was postponed to 2040, and the ship was informed that it would take 30 minutes to connect. With the ship's rate of drift, it was assessed that STENA SCANDICA would reach shallow waters at 2050. This meant that the tugboat would not reach STENA SCANDICA in time unless the drift was reduced. Forty-five minutes later, the rate of drift remained the same and the distance to shore was assessed at 8 nm. The company therefore requested the master to plan for when and how to evacuate the passengers. By now, the engine team had managed to start the main generator.



Figure 10: STENA SCANDICA's position at 1545.  
Source: SafeSeaNet Ecosystem GUI, modified by DMAIB

- 1741 ○ At 1741, the master reverted with a plan for evacuation. He informed the company that he wanted to use the lifeboats for evacuation and that this had to be carried out in daylight. As darkness started to fall at 2000, the deadline for evacuation was 1900. However, the master wanted to keep the passengers on board for as long as possible, and he hoped that the engine team would manage to restore propulsion. With the current rate of drift, the ship was expected to reach shallow waters at approximately 2100.
- 1833 ○ At 1833, it was decided to evacuate the most vulnerable passengers by helicopter. A group of 69 persons, comprising families with children and persons with limited mobility, were identified. The rescue helicopter was expected to reach STENA SCANDICA at 1900, and it had the capacity to carry six passengers at a time. The passengers were to be evacuated to a smaller passenger ship nearby.
- 1855 ○ At 1855, as the deadline for evacuating the passengers by lifeboat approached, the Swedish Rescue assessed that evacuating the passengers by lifeboat was too dangerous. At this point, the engine team had restored power to the main engines and was preparing to start them. At the same time, the bosun managed to loosen the starboard anchor chain and lower the anchor to ten shackles. This reduced the drift and increased the time until the ship reached shallow waters to 3 hours. Therefore, the evacuation by lifeboat was not commenced at 1900 as intended.
- 2000 ○ At 2000, the starboard main engine was confirmed to be running. A few minutes later, the port main engine was started, and the bridge steering was restored. At 2020, the master slowly manoeuvred the ship to keep the ship in its current position.
- 2052 ○ Thirty minutes later, both anchors were heaved, and the ship proceeded northwards at 5 knots (Figure 11). At 2052, evacuation by helicopter was stopped. By then, thirty-three passengers had been evacuated from the ship.





Figure 11: STENA SCANDICA's position at 2050.  
 Source: SafeSeaNet Ecosystem GUI, modified by DMAIB

2104 ○

At 2104, a helicopter in the area observed flames coming from STENA SCANDICA's funnel. The port main engine was temporarily stopped while the external firefighters investigated the situation. It was determined that it was not an actual fire, but a brief ignition of gas oil residues in the funnel, which was considered normal during start-up. The ship proceeded to Nynäshamn at slow speed.

The only available means for navigating the ship were an AIS, a GPS, an iPad and paper charts. The master asked the ETO if he could try to restore power for the navigational equipment. The ETO went to the emergency generator room to resolve why the navigational equipment was without power. While he was working, the chief officer entered the emergency generator room and told the ETO that the ship had blacked out once more. The ETO had not noticed the blackout as the lights in the emergency generator room were powered by the UPS, and the emergency generator had been running since the first blackout. He immediately started to assist the chief engineer on restarting the ship, and they decided to stop restoring equipment which were not essential for manoeuvring. At 2243, propulsion and power were once again restored, and STENA SCANDICA proceeded towards Nynäshamn at a speed of 5 knots, using only one main engine.

2243 ○

The crew kept the passengers gathered in the lounge and restaurant areas on Deck 5 for the remainder of the voyage, as the smoke detector system was out of order. The crew tried to make the passengers as comfortable as the circumstances allowed and handed out pillows, blankets and sandwiches.

The master stayed on the bridge until 0030 and then went to his cabin to get some rest before the pilot embarked. The ETO and the chief engineer stayed in the ECR and a watchman was kept on Deck 4 until the ship was alongside. Fire patrols on the ship were ongoing.

30 August 2022  
 1103 ○

At 1103 on 30 August 2022, STENA SCANDICA secured alongside in Nynäshamn, Sweden. No crewmembers or passengers were injured during the fire, the blackout or the evacuation.

# Investigation of fire

## Scope of the investigation

The course of events showed that the firefighting team observed a fire in a truck on Deck 4, and they managed to contain the fire and extinguish it. The cause of the fire was unknown.

DMAIB launched an investigation to determine the cause of the fire by establishing the origin of the fire, the source of ignition and how the fire spread.

The investigation is based on DMAIB's on-site fire analysis and photo documentation of the scene after STENA SCANDICA's arrival in Nynäshamn, along with CCTV footage, witness testimonies and technical drawings.

The following description of the fire investigation is deliberately concise to enhance readability. Consequently, it only presents the findings which DMAIB found relevant to gain an overall understanding of the fire. It does therefore not reflect the methodology used when investigating fires.

## Fire scene

DMAIB requested the crew of STENA SCANDICA not to remove items or vehicles from vehicle Deck 4 upon the ship's arrival. When DMAIB arrived at the site of the fire, it was cordoned off while the site was examined and documented (Figure 12).

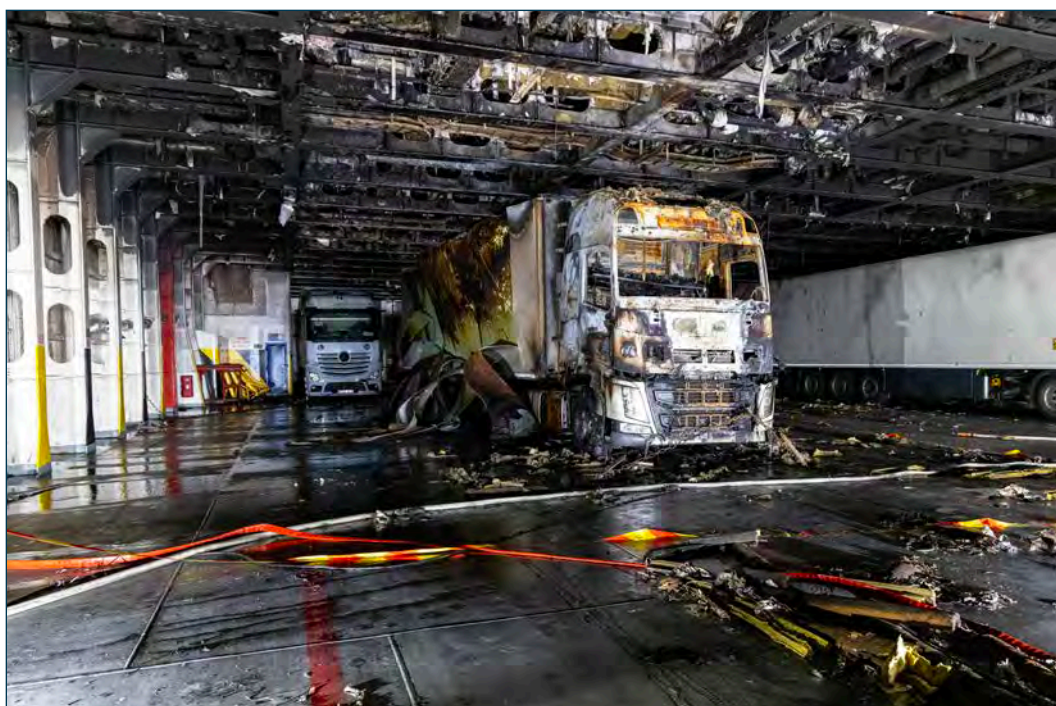

Figure 12: Fire scene on Deck 4.  
Source: DMAIB

Vehicle Deck 4 was an open Ro-Ro space. On the aft part of the deck, the side plating had openings, while the forward part was sheltered. On the forward bulkhead, fire dampers were found open, with indications that they had been open during the fire. The various openings created a natural ventilation for the entire vehicle deck (Figure 13).

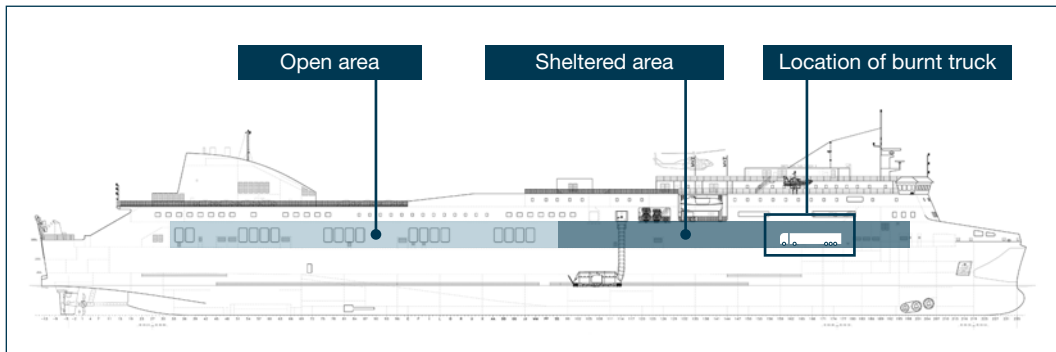

Figure 13: Open and sheltered area on Deck 4.  
Source: Stena Rederi A/S, modified by DMAIB

When entering Deck 4, the forward sheltered part was fire-damaged. Fireproof insulation had fallen from the deckhead onto the deck, and debris from burning material lay scattered on the deck. Some of the debris had melted onto the deck or caused superficial heat damage, but otherwise the deck structure was intact. The deckhead and upper part of the bulkhead were covered in soot, and melted plastic was hanging from fluorescent light fixtures (Figure 14).



Figure 14: Deckhead above truck burnt clean from paint and soot.  
Source: DMAIB

On the port side, localised extensive fire damage was observed on the deckhead. Steel had burned clean of soot and paint, and cables fitted in cable trays on the deckhead were laid bare as the insulation had burned away. This indicated that the area had been impacted by high temperatures from radiation heat or direct exposure to a flame plume. Below this area, a truck was located with extensive fire damage on the cab and trailer.

In total, six trucks, all carrying reefer trailers and facing aft, were stowed in the forward sheltered area of the Deck 4. The remaining five trucks were intact, with only soot marks and slight heat damage from burning debris that had fallen onto their cabs.

During the examination of the fire scene, DMAIB identified that the lowest point of fire damage and the area most affected by heat was located on the burnt truck, indicating that the origin of the fire was on the truck or the trailer.

## Origin of the fire

---

The burnt truck was manufactured by Volvo, of the type Volvo FH13, model FH13A42t, from 2017 (Figure 15). The truck was owned and operated by the Lithuanian transport company Vlantana. The last service was carried out on 25 October 2021 and was performed by an authorised Volvo service centre. The truck carried a refrigerated trailer built in 2021 by Schmitz Cargobull (Figure 16). The trailer's cooling system was manufactured by Thermo King, and the refrigerating unit was connected to STENA SCANDICA's power supply system by a 440V cable during the voyage. At the time of the fire, the trailer was loaded with berries.



Figure 15: VOLVO FH13.  
Source: VOLVO Denmark

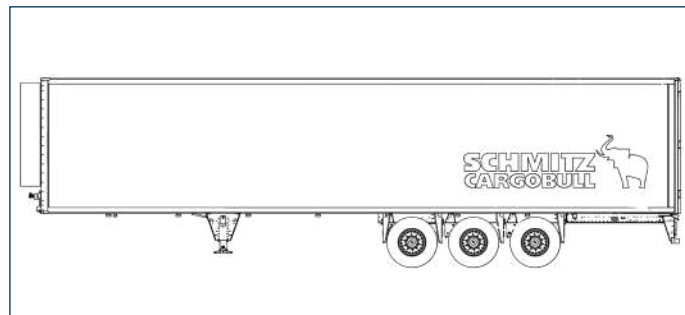

Figure 16: Scmitz Cargobull trailer.  
Source: Schmitz Cargobull

Examination of the truck showed that the truck's cab had been gutted by the fire. The fire damage centred on the front bumper, leaving the sides of the grille and the headlights intact. On the bonnet and the engine bay, the centre had burnt clean from paint and soot, while the corners of the bonnet were burnt clean from paint, but not soot. The cab's windows were missing and were found in misshapen pieces on the deck below. All combustible interior within the cab had burnt away. Both front tyres were intact (Figure 17).



Figure 17: Fire damages on truck front.  
Source: DMAIB

On the trailer's right-hand side (looking from behind), the top bracket had melted and was no longer holding the outer aluminium plating, and the roof had partly collapsed (Figure 18). The inner plating displayed a semi-circular burn pattern covering 2/3 of the trailer's side, starting from its top front corner. In this area, the metal had blackened and oxidised and had been deformed by the heat impact. Below the bottom front corner of the trailer, a black plastic tank was installed on the outside of the truck's chassis. The plastic tank had minor heat damages, but was otherwise intact. This indicated that the heat impact had been limited in this area.



Figure 18: Fire pattern on the truck's right side.  
Source: DMAIB

On the left-hand side of the trailer, the outer aluminium plating had similarly loosened from the collapsed top brackets (Figure 19). The inner plating was marked by a burn pattern differing significantly from the other side of trailer. The burn pattern on the trailer's left side started from the bottom front corner and fanned diagonally upwards to the rear top corner.

The fire pattern on the truck's cab and the diagonal fire pattern on the trailer's left side formed a V pattern rooted at the truck's chassis in the gap between cab and trailer. The V pattern indicated that fire had been present in the gap and spread up and out, possibly indicating the fire's point of origin. Therefore, this area was excavated from the burned debris and examined further.



Figure 19: Fire pattern on the truck's left side.  
Source: DMAIB

On the front of the trailer, the engine for the trailer's cooling unit was located. The inlet for the ship's power supply cable was located at the bottom of the cooling unit casing. All combustible material on the cooling unit was burned away, melted or deformed (figure 20). The part of the ship's power cable connected to the cooling unit was found melted and burned (figure 21).



Figure 20: Fire damaged cooling unit.  
Source: DMAIB



Figure 21: Melted power cable inlet.  
Source: DMAIB

In the area between the cab and the trailer, below the cooling unit, the starter battery for the truck was mounted on a steel platform on the left-hand frame of the chassis. A power cable of unknown origin was found stuck on the left side under the batteries. Behind the battery, a steel plate was mounted on the frame on which a fuse box had been installed (Figure 22).



Figure 22: Starter battery mounted on the chassis.  
Source: DMAIB



The starter battery and the fuse box installation behind on the left side of the chassis had been exposed to high heat intensity and were entirely burnt out. All plastic covers, boxes and insulation on the cables had burned away. The fuse box bus bar was found behind the battery. It was observed that one fuse stud was found welded to the steel plate, which the fuse box had been mounted on (Figure 23 and 24). In order for steel to weld, temperatures of a minimum of 1,538°C are required. A fire plume normally has a maximum temperature of 1,400°C, whereas electrical faults can result in much higher temperatures. Therefore, DMAIB determined that a short circuit had occurred in the fuse box.

On the right-hand side of the chassis, insulation on the cables remained intact (Figure 25).

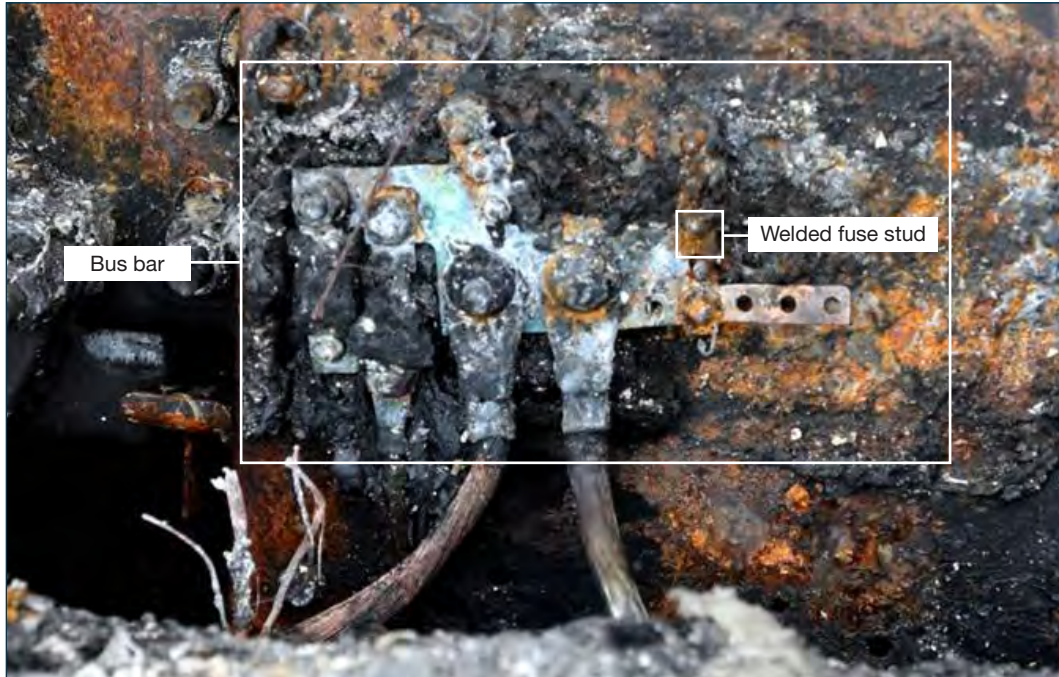

Figure 23: Remains of fuse box bus-bar.  
Source: DMAIB

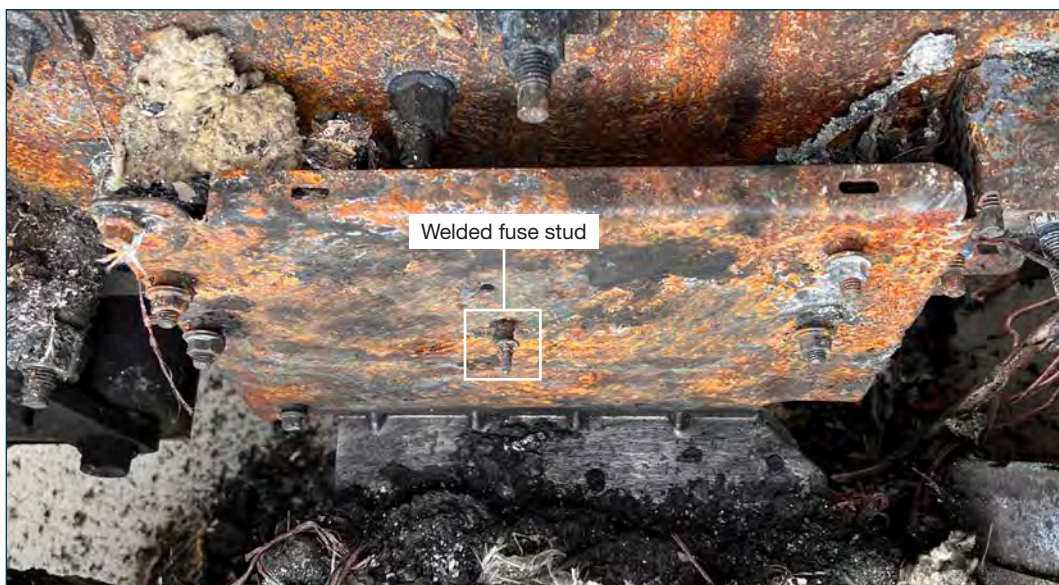

Figure 24: Fuse stud welded to steel plating.  
Source: DMAIB



Figure 25: Undamaged plastic and rubber components on right-side chassis.  
Source: DMAIB

The damage and the fire pattern in the gap between the cab and the trailer showed that the highest temperatures and fire load had been present locally on the left side of the chassis by the starter battery, and that the fire had spread up and out from this point.

Consequently, the gap between the truck and trailer was the origin of fire (figure 26).

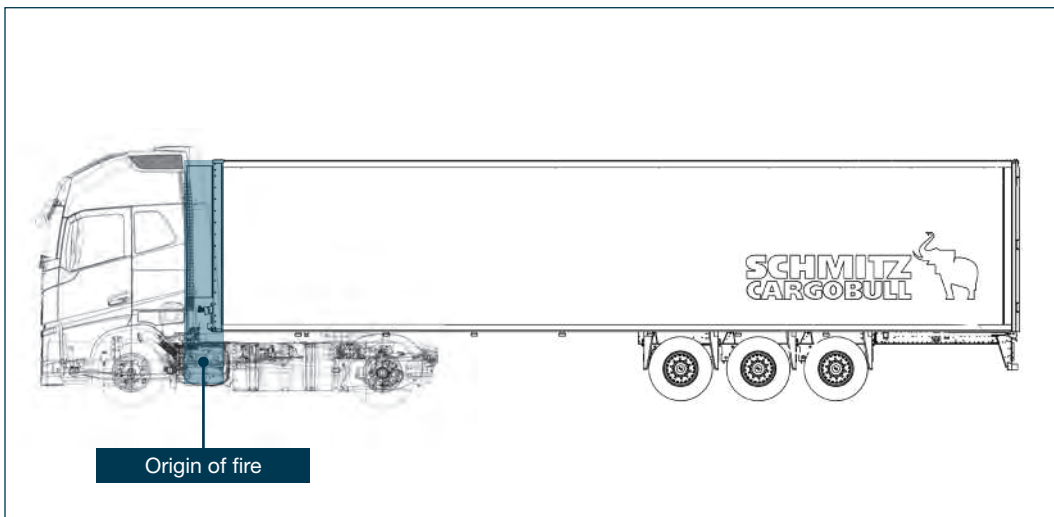

Figure 26: Origin of fire.  
Source: VOLVO Denmark/Schmitz Cargobull, modified by DMAIB

# Source of ignition

---

The following potential sources of ignition were located in the gap between the truck and trailer:

*Mechanical failure in the cooling unit:*

A mechanical failure in the cooling unit could develop heat and ignite surrounding flammable material. During the investigation, DMAIB did not observe any indications of a violent mechanical malfunction. However, the unit was severely damaged by the fire that it could not be ruled out that a malfunction had occurred which caused ignited material to burn through the cooling unit's casing and fall on top of the truck's battery casing igniting oil and grease residues.

*Electric fault on cables connecting the cooling unit to ship's power supply:*

The power cables from the ship to the cooling unit could short circuit and the arc could ignite surrounding flammable material. DMAIB found that the sockets connecting the ship's and cooling unit's power cables were melted. The cables were handed over to the Swedish Police for further forensic examination. Swedish Police did not find evidence of short circuit on the cables. Volvo subsequently carried out a fire investigation on the truck and trailer and found metallic spray resembling copper in the area of the power connection to the cooling unit. Such copper spray could indicate failure on one of the power cables. It has not been possible for DMAIB to verify the observations made by Swedish Police and Volvo. It hence remains unknown to DMAIB whether an electric fault had occurred on the power cables.

*Battery failure:*

The truck's starter battery could malfunction and develop hydrogen and heat which could ignite surrounding flammable material. However, the battery was destroyed by the fire and a failure stemming from before the fire could not be observed (figure 27).



Figure 27: Damaged starter battery.  
Source: DMAIB

*Short circuit of unauthorised power installation at battery:*

The cable of unknown origin found stuck under the battery frame indicated that an unauthorised installation had been made. The nature of such an installation could not be determined due to the extensive damage caused by the fire. No indications of a short circuit related to the fire were observed (Figure 28).

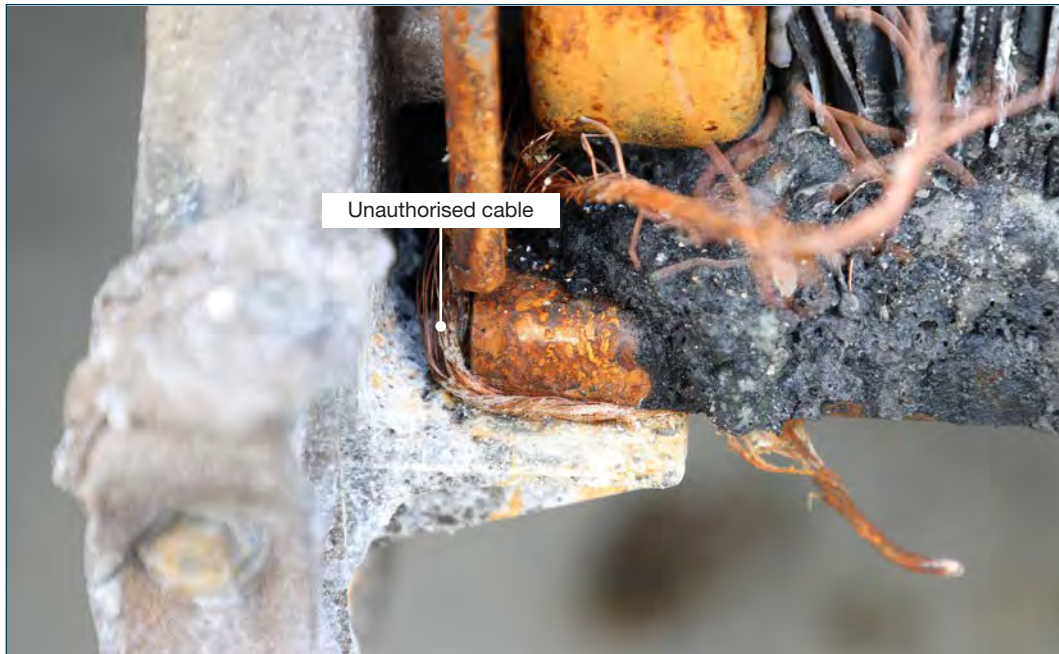

Figure 28: Unauthorised power installation.

Source: DMAIB

*Short circuit on cables connecting battery:*

The starter battery consisted of two 12V batteries connected in series. A cable shoe on the cable joining the two batteries was affected by high temperature which could indicate a fault on the wire connection. However, it could not be determined whether this failure occurred as the primary ignition or was secondary. (Figure 29).

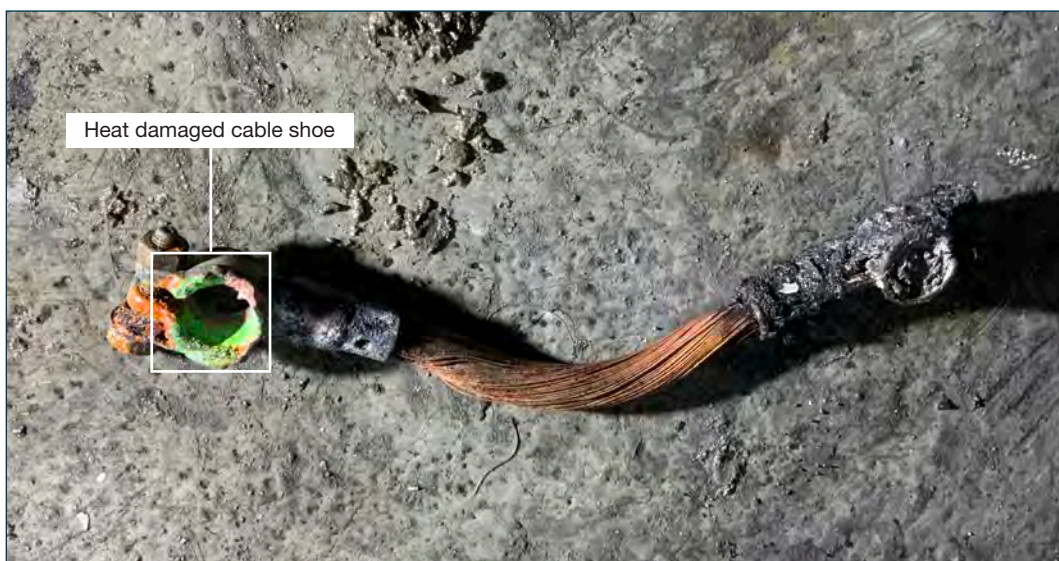

Figure 29: Heat damaged cable shoe on battery wire connection.

Source: DMAIB

*Short circuit inside fuse box:*

The plastic casing ensured that the conductor charged from the battery's positive terminal was isolated from the negative grounded chassis. If a breach occurred on the casing, a short-circuit electric arc could occur. As one of the fuse studs was found welded to the chassis, DMAIB found it that an arc flash had occurred due to failed insulation on the fuse box. However, it was found that the fuse stud was not welded in its original place indicating that the fuse box had been deformed by the fire and shifted its position before fuse stud welded to the steel plating (Figure 30 and 31). This means that the short circuit in the fuse box most likely was secondary.

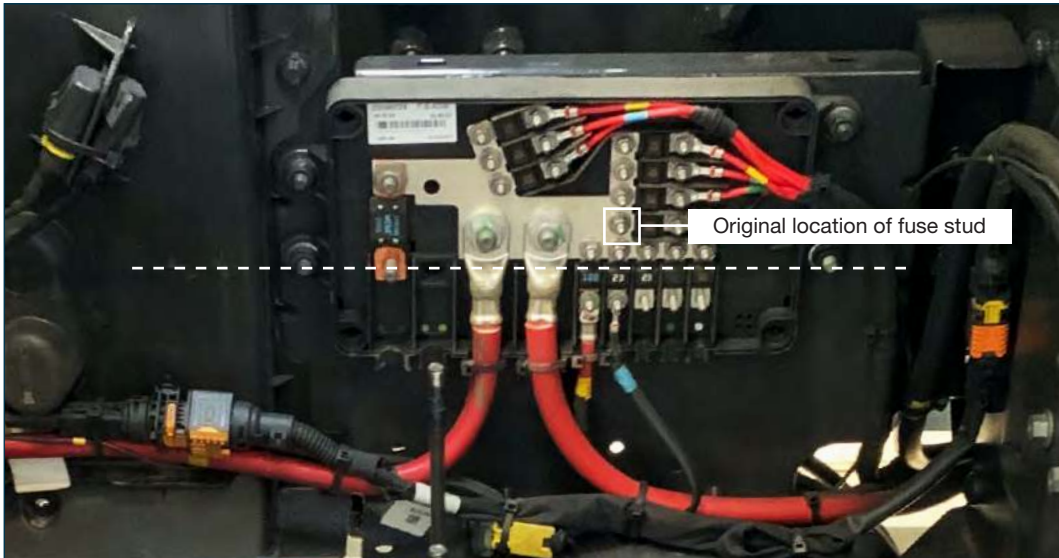

Figure 30: Location of fuse stud  
Source: DMAIB



Figure 31: Heat damaged cable shoe on battery wire connection.  
Source: DMAIB

*Conclusion on source of ignition:*

The gap between the truck and trailer comprised several possible sources of ignition. Due to the severe fire damages in the area, the primary source of ignition could not be determined with certainty.

## Fire spread

---

Deck 4 was covered by CCTV, which viewed the rear of the truck's trailer, and the footage did not capture the start of the fire. However, at 1216<sup>3</sup> smoke was recorded on the vehicle deck, indicating that combustible material had ignited, or was at least smouldering (Figures 32 and 33). Two minutes later, at 1218, the atmosphere filled with black smoke, indicating that the fire had spread and intensified (Figure 34).



Figure 32: Deck 4 at 12:13:01. No visible smoke.  
Source: DMAIB



Figure 33: Deck 4 at 12:16:05. Visible smoke.  
Source: DMAIB

---

3 The time stamps on the CCTV recordings are inconsistent with other data sources and have been determined to be approximately 3 minutes ahead. This has been adjusted for in the text.



Figure 34: Deck 4 at 12:18:00. Deck 4 covered by smoke.  
Source: DMAIB

Both the truck and the trailer contained many oil- and fibre-based materials, such as lube oil, plastics and textiles, which were highly combustible. This made it possible for the fire to spread to the cab, the interior of which was plastic and fabric interior, and to the engine containing grease and oil. The fire triangle of heat, fuel and oxygen was completed by the fresh air flowing from both ends of the vehicle deck.

On the trailer's cooling unit, grease and oil also ignited, spreading the fire to plastic and rubber parts on the front end of the trailer, which started to melt the aluminium frame on the trailer. As the aluminium top bracket collapsed, the trailer opened and the fire spread inside the trailer. Due to the berries' water content, the cargo had low combustibility and mainly contributed heavy smoke and the development of soot. The open space between the truck and the trailer created a chimney effect by directing the flames and the rising heat towards the deckhead. CCTV footage showed that, at 12:19, burning material was falling from the deckhead and the deck area was lit up by flames (Figure 35).



Figure 35: Deck 4 at 12:19:12. Deck 4 covered in black smoke with burning debris in the atmosphere.  
Source: DMAIB

Two minutes later, CCTV recording ceased from the cameras on Deck 4, most likely due to heat impact on the cameras.

In the area above the opening between cab and trailer, soot was burned away, indicating that the deckhead was subjected to high temperatures which damaged the insulation on the cables installed in trays on the deckhead (Figure 36).



Figure 36: Fire damages to the deck head above the burning truck.  
Source: DMAIB

Decks 4 and 5 were divided by an A-60 class steel deck. The performance criteria for a class A-60 division are, among other things, that it is to be constructed and insulated to retain its integrity and limit heat radiation, so that the temperature on the unexposed side will not rise more than 180°C above the original temperature at any one point for 60 minutes.

On Deck 4, water from the firefighting soaked and loosened the fastenings of the fireproof insulation which separated from the deckhead and fell to the deck. With the steel exposed to the heat from the fire, heat radiation occurred in the passenger area above the burning truck. During the fire, crew members monitored the temperatures in the compartments adjacent to the fire scene using a thermal scanner. On Deck 5 in the lounge and reception area, surface temperatures of 60°C were read, and boundary cooling was initiated at 1253. When the carpet in the lounge area was removed following the fire, significant heat damage to the carpet adhesive was found at a covered cable duct located just above the fire scene on Deck 4 (Figure 37).

The adhesive was blackened and had disintegrated in patches where the adhesive had been smouldering (Figure 38). The fire did not develop in the passenger area, largely due to the fire-retardant properties of the floor coverings and the firefighting activities.

The fire did not spread to other vehicles because the sheltered part of Deck 4 was not stowed to its full capacity, and the burning truck had empty lanes either side (Figure 39). Furthermore, no vehicles were stowed directly in front of the truck and, although two trucks were stowed behind, they were not affected by flames because the fire did not spread to the rear of the trailer of the burnt truck.



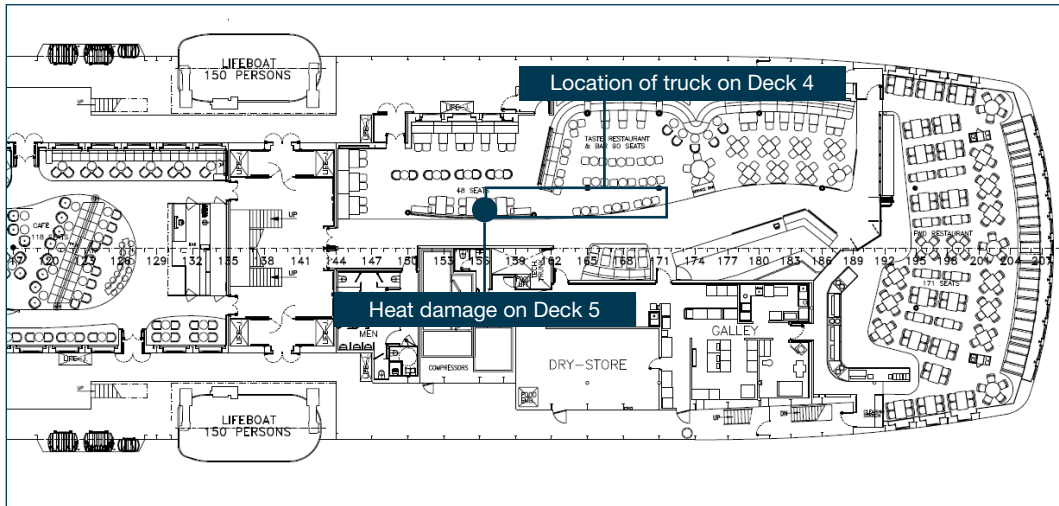

Figure 37: Location of heat damage in lounge area on Deck 5 and indication of truck position on Deck 4.  
Source: Stena Rederi A/S, modified by DMAIB



Figure 38: Heat damage to the adhesive.  
Source: DMAIB

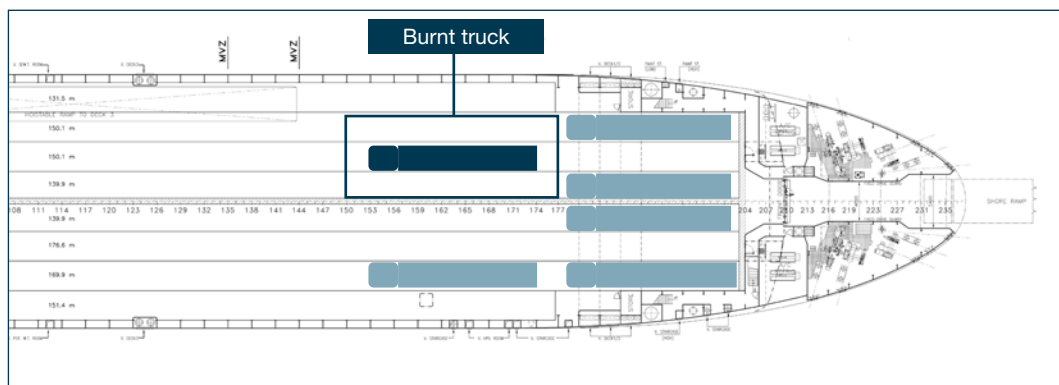

Figure 39: Stowage of trucks in the sheltered part of Deck 4.  
Source: Stena Rederi A/S, modified by DMAIB

# Firefighting

---

The firefighters on STENA SCANDICA managed to extinguish the fire on Deck 4 by means of drenchers and fire hoses.

The fire was detected by optical smoke detectors on Deck 4 at 1215. At 1229, firefighters confirmed that drenchers were running in the four forward drencher sections on Deck 4. The firefighting teams had six firefighters working in pairs of two who took turns entering the smoke-filled area in the enclosed part of Deck 4 to locate the fire. According to VDR recordings, the master reported to Swedish Rescue at 1256 that the fire was located and under control. At 1317, the master informed Sweden Rescue that there was no longer open fire on vehicle Deck 4, but cooling was ongoing. Fifteen minutes later, the crew lost the water supply for drenchers and fire hoses, as the ship suffered a total blackout.

Water supply for the drencher system was provided by the fire pump, which was powered by the main power system. When the blackout occurred at 1332, the fire pump lost power supply, resulting in the drencher system being inoperational until the power supply from the main generator was restored at 1716.

Water supply for the ship's fire hydrants was provided by the main fire pump, supplied by the main power system, and the emergency fire pump, supplied by the emergency switchboard. As the blackout at 1332 included loss of emergency switchboard services, the fire hydrants were inoperative until emergency power was restored at 1500.

At 1500, shore-based firefighters boarded STENA SCANDICA to assist. However, they did not bring any firefighting equipment and were reliant on the equipment carried on board. Although fire pumps and hoses were available on board the rescue boats which were now in the vicinity, the equipment could not be transferred to STENA SCANDICA due to the sea conditions.

This meant that for 1.5 hours the only firefighting means were portable extinguishers, and for 3 hours and 45 minutes the drencher system was not available.

## Key points of the fire investigation

---

- The fire was ignited and developed from the left side of the gap between the truck and trailer. In that area were a number of potential sources of ignition, and the investigation did not conclusively establish the primary cause of ignition.
- Due to loading conditions on the day of the accident, the fire did not spread to the other vehicles on the car deck.
- The crew succeeded in extinguishing the fire before blackout occurred and water supply for drenchers and fire hydrants was lost
- The heat-retardant properties of the A-60 division between the vehicle deck and the passenger decks were impaired, as insulation fell from the deckhead when soaked by water during the firefighting.

# **Investigation of blackout**

## Scope of the investigation

The course of events showed that the navigational officers experienced failures on the bridge equipment shortly after the fire was detected at 1215. One hour and fifteen minutes after the fire broke out, a total blackout of the ship occurred resulting in the ship drifting uncontrollably for 6.5 hours until propulsion was restored at 2000.

DMAIB launched an investigation into the loss of power supply, focusing on:

- Why both the main and emergency power supplies failed following the fire.
- How the electrical system failure was detected by the crew.
- How the power supply was restored.

To describe the conditions leading to the blackout, DMAIB examined the statutory requirements for on-board power supply systems, documentation of damages, witness testimonies, technical diagrams, VDR data, internal technical reports and the engine alarm log.

The crew's detection and understanding of the electrical failure while the emergency was ongoing were established by means of witness testimonies, VDR data, photo documentation and alarm logs.

Finally, the descriptions of the strategies and resources for re-establishing power supply from a dead ship condition and restoring directional control of the ship are accounted for were based on witness testimonies, photo documentation, and technical drawings and procedures. The aids available to the crew as they were troubleshooting the power supply system were also researched.

## Statutory requirements for electrical power supply on Danish passenger ships

STENA SCANDICA was a passenger ship registered in Denmark and engaged in international voyages. It was therefore obliged to adhere to the requirements laid out by the Danish Maritime Authority in the Order on Notice B from the Danish Maritime Authority, the construction and equipment, etc. of ships<sup>4</sup>, which comprised, among other things, provisions on electrical installations (Notice B, Chapter II-1, Part D, Electrical installations).

---

<sup>4</sup> Order no. 1512 of 8 December 2016, issued by the Danish Maritime Authority

The provisions on electrical installations were essentially based on the International Convention for the Safety of Life at Sea (SOLAS) 1974. In the following, provisions concerning main and emergency power sources and power distribution are presented.

The main source of electrical power should be sufficient to supply all electrical auxiliary services necessary for maintaining the ship in normal operational condition and should consist of at least two generating sets (Rule 40 and 41). The generating sets must ensure that with any one generator or its primary source of power out of operation, the remaining generating sets are capable of providing the electrical services necessary to start the main propulsion plant from a dead ship condition. The emergency source of electrical power may be used for the purpose of starting from a dead ship condition (Rule 41).

The electrical installations must ensure services essential for safety under various emergency conditions (Rule 40). For this purpose, a self-contained emergency source of electrical power should be provided which should be located above the uppermost continuous deck, along with the associated transforming equipment and emergency switchboard. The location serves to ensure that a fire or other casualty in spaces containing the main source of electrical power and the associated main switchboards and transforming equipment will not interfere with the supply, control and distribution of emergency electrical power (Rule 42).

The electrical power available is required to be sufficient to supply all services that are essential for safety in an emergency within specific periods:

For a period of 36 h, the following services must be supplied by the emergency power system:

- Emergency lighting in parts of the accommodation and machinery rooms essential during the accident, such as mustering points, alleyways, machinery control rooms, control stations, fire lockers and at emergency pumps
- Navigation lights
- VHF radio installation
- Fire detection and fire alarm systems, and the fire door holding and release system
- Navigational equipment
- All internal communication systems

For a period of 18 h:

- One of the fire pumps
- The automatic sprinkler pump
- The emergency bilge pump

For a period of 30 min:

- The steering gear
- Watertight doors
- The emergency arrangements to bring the lift cars to deck level for the escape of persons.

Where electrical power is necessary to restore propulsion, the capacity should be sufficient to restore propulsion to the ship in conjunction with other machinery from a dead ship condition within 30 min after blackout.

The emergency source of electrical power may be either a generator or an accumulator battery. Where the emergency source of electrical power is a generator, it shall be started automatically upon failure of the electrical supply from the main source of electrical power and shall be automatically connected to the emergency switchboard. The emergency generator should be able to start and carry its full rated load within 45 seconds. Furthermore, a transitional source of emergency electrical power shall be provided. The transitional source of emergency electrical power shall consist of accumulator batteries which in the event of failure of either the main or emergency source of electrical power automatically supply at least the following services for 30 minutes:

- Emergency lighting in parts of the accommodation and machinery rooms essential during the accident, such as mustering points, alleyways, machinery control rooms, control stations, fire lockers and at emergency pumps
- Fire detection and fire alarm systems, and the fire door holding and release system
- All internal communication systems required during an emergency situation
- Watertight doors

During normal operations, the emergency switchboard shall be supplied from the main switchboard by an interconnector feeder. The feeder line is to be protected at the main switchboard against overload and short circuit and is to be disconnected automatically at the emergency switchboard upon failure of the main source of electrical power.

Cables and wiring serving consumers essential or emergency power, lighting, internal communications or signals shall so far as practicable be routed clear of galleys, laundries, machinery spaces of category A and their casings and other high fire-risk areas. Cables connecting fire pumps to the emergency switchboard shall be of a fire-resistant type where they pass through high fire-risk areas. Where practicable all such cables should be run in such a manner as to preclude them from being rendered unserviceable by heating of the bulkheads that may be caused by a fire in an adjacent space (Rule 45).

## Electrical power supply system on STENA SCANDICA

---

On STENA SCANDICA, the main switchboard and emergency switchboard were part of a single integrated distribution system supplying power for the entire ship in normal operation. The main switchboard was located in the engine control on Deck 3 on the aft part of the ship and was supplied from three diesel generators in the engine room. The main switchboard was connected to the emergency switchboard in the emergency generator room on Deck 8 on the fore part of the ship by a feeder line supplying 440V to the emergency switchboard. The circuit breakers for the feeder line at both the main switchboard and the emergency switchboard would automatically open in the event of short circuits or overload.

The emergency switchboard consisted of a 440V section and three 220V sections, two of which were connected to UPS battery packs in the battery room adjacent to the emergency generator room. Furthermore, a combined switchboard/UPS converting from 440V to 24V was supplied from the emergency switchboard.

A diagram of the 24V distribution during normal operation is shown below (Figure 40):

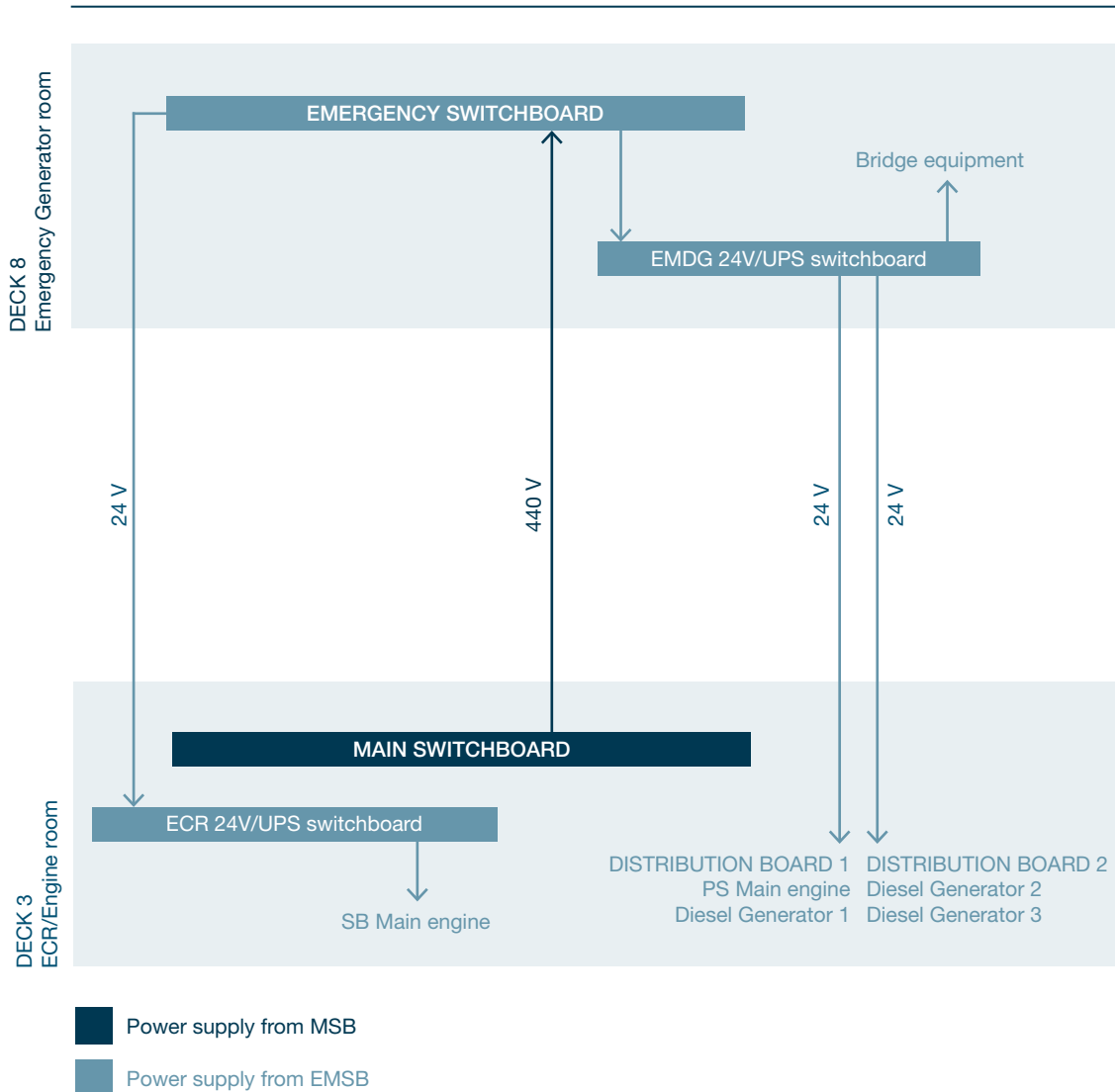

Figure 40: 24 V power supply distribution on STENA SCANDICA.  
Source: DMAIB

The 24V switchboard/UPS supplied three distribution boards: one for bridge equipment on Deck 7 and two distribution boards located in the engine room on Deck 3. The 24V distribution boards in the engine room supplied control voltage to, among other things, the port side main engine and the three diesel generators, and the 24V service was essential for the operation of the ship. An additional 24V switchboard/UPS was located in the engine control room and was also supplied from the emergency switchboard. The 24V switchboard/UPS in the engine control room supplied control power to the starboard main engine only.



In the event of a failure occurring on the electrical system that resulted in 440V not being provided from the main switchboard to the emergency switchboard, a sensor in emergency generator's control system detected a drop in voltage which initiated the automatic starting of the emergency generator to provide 440V to the emergency switchboard. In the time between the voltage drop and the emergency generator running on full load, the services and equipment connected to the 24V switchboards/UPS and 220V/UPS sections on the emergency switchboard were supplied with power by batteries, thereby ensuring an uninterrupted supply. The UPS batteries were also able to provide power for a limited time in case of failure on the emergency switchboard.

During a failure of the main power supply system, the emergency system was designed to perform independently of the main switchboard, to supply equipment and services essential for the safety of the ship, and to restore power in case of total blackout (Figure 41). However, the main power supply system was dependent on the emergency power supply being in working order, as most of the essential services was supplied via the emergency switchboard.

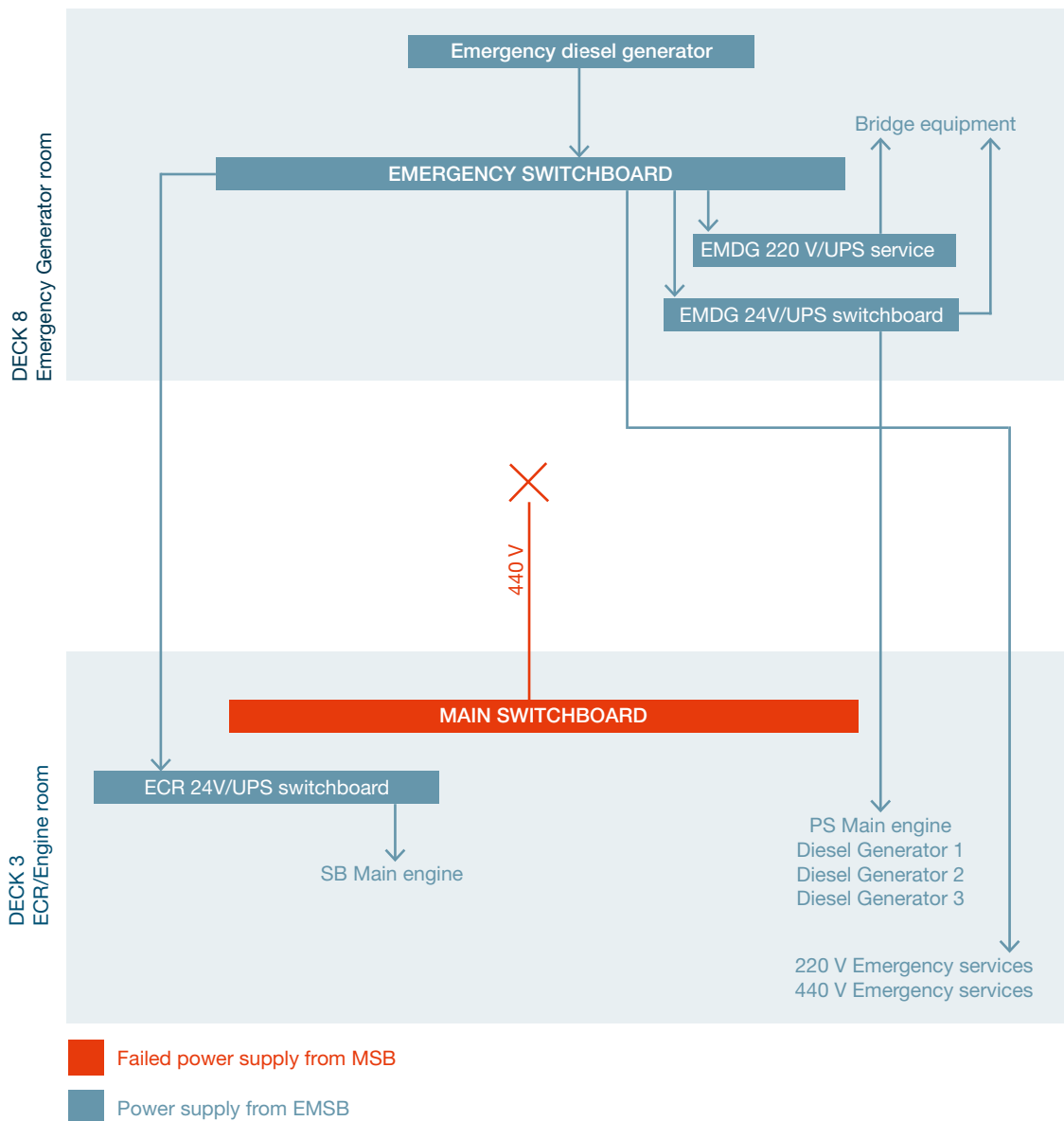

Figure 41: Emergency electric power distribution on STENA SCANDICA.  
Source: DMAIB

# Cable layout

Photo documentation of the fire scene proved that several cable trays were fitted in the area directly above the truck on fire (Figure 42). However, the cable diagrams valid at the time of the accident indicated there were no cable trays installed in this area (Figure 43). The diagram did not correspond with the actual layout on Deck 4. Furthermore, no information was available regarding which cables were in the cable trays above the truck.



Figure 42: Burnt cable trays visible directly above the truck.  
Source: DMAIB

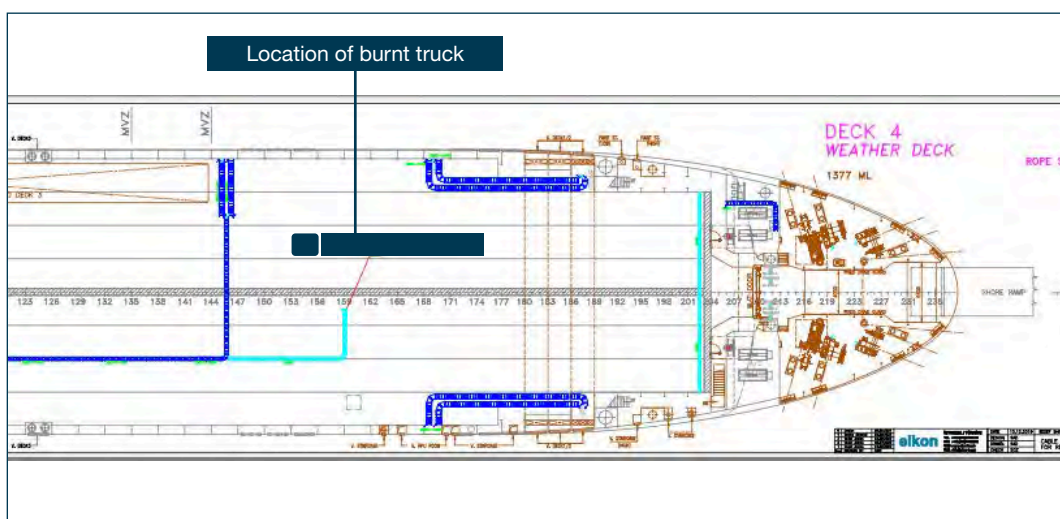

Figure 43: Cable tray diagram Deck 4.  
Source: Stena Rederi A/S, modified by DMAIB

According to interviews with the crew, the circuit breakers connecting the main switchboard and emergency switchboard had automatically opened during the fire, and sparks were seen coming from the cable trays above the burnt truck on Deck 4 during the attempts to close the breakers for electrical services in the engine room on the emergency switchboard. This indicates that cables connecting the emergency switchboard with the main switchboard and services in the engine room were in the cable trays affected by the fire.

## Electrical system failure

---

### Description of the power supply failure leading to dead ship condition

Following the fire, STENA SCANDICA suffered a loss of power resulting in the main engines and diesel generators being out of operation. The ship was in a dead ship condition. The electrical system failures leading to dead ship condition on STENA SCANDICA are now presented in chronological order.

The description of system failures is based on an analysis of data recorded in the ship's engine alarm log and VDR and the crew's observations. However, it is recognized at the accuracy and detail of some of this data was limited because the logged data and alarms were affected by the damage to the electrical system caused by the fire and the subsequent power supply failure. In addition, the crew had to replace units and alter electrical connections during the restoration of power, and it was therefore not possible for DMAIB to examine electrical faults as they appeared immediately after the blackout. Finally, there was a time difference between the engine alarm log and the VDR, but due to inconsistencies between the entries in the two mediums, the exact time difference cannot be calculated. For presentation purposes, DMAIB has used an approximate value of +2 minutes for the engine alarm log entries to facilitate a general alignment with the VDR data.

**12:15:36** The first fire alarm is recorded in the engine alarm log. On the VDR, the fire alarm from the fire panel is audible at 12:15:22.

**12:18:09** A circuit breaker trip alarm for the 24V switchboard/UPS located in the emergency generator room is recorded in the engine alarm log. The 24V switchboard/UPS supplied two distribution boards in the engine room and one distribution board on the bridge. The connecting cables for the distribution boards in the engine room were led across the area above the burning truck on Deck 4. The trip alarm was most likely activated when one of the cables was damaged by the fire, causing it to short circuit. VDR recordings show that bridge equipment supplied by the 24V switchboard/UPS was working, indicating that its 24V switchboard was still operational.

**12:18:49** Many communication error alarms started to appear in the engine log. The alarms indicate that the communication cable which fed the alarm monitoring system with information from the bridge equipment was now affected.

The communication cable was led along the deckhead above the burning truck. It cannot be ruled out that the adverse effects of the fire and heat on the communication cable resulted in either faulty information being recorded in the engine alarm log and VDR. Important information might not also have been recorded at all.

12:22:11 -  
12:25:05

Alarms for UPS2 and UPS3<sup>5</sup> are recorded in the engine alarm log. For UPS2, a bypass and low output alarm is recorded, which indicates that for UPS2 a failure occurred on the unit, and it was not providing power to services. For UPS3, an on-battery and low input alarm was recorded, indicating that UPS3 was not supplied with power, but running on its batteries.

Co-incident with the on-battery alarm for UPS, the VDR started to lose inputs over a 3-minute period as follows:

- Indication for both propellers that pitch, and rotation speed are stopped
- Alarm for fail on both propeller pitch controls is displayed
- X-band radar and ECS lose signal from GPS1 and GPS2
- Bridge telegraph data is stopped
- S-band radar shuts down
- Echo sounder input is stopped
- Speed log data is stopped
- AIS data is stopped
- Rudder indications are stopped

By the end of the three minutes, an alarm was showing a lost AC power and on-battery alarm, and the VDR had stopped recording all inputs other than bridge audio. The bridge audio records indicate that at about the same time as the VDR lost its inputs, the bridge team became aware that GPS and control of steering was lost and they had ordered emergency steering to be started.

Propeller pitch controls were directly supplied from the 24V switchboard/UPS in the emergency generator room. VDR, AIS, rudder indication and GPS1 were supplied with 24V by the bridge distribution board connected to the 24V switchboard/UPS. Radars, X-band radar, echo sounder and VDR were supplied by the 220V section of the emergency switchboard without UPS.

Together, the UPS on battery and the loss of VDR input indicate that no voltage was present on the emergency switchboard, and that the power supply from both the main switchboard and the emergency generator had now failed. The feeder line from the main switchboard to the emergency switchboard ran across the deckhead above the burning truck.

The loss of voltage indicates that the cable had been damaged and the built in short-circuit protection had activated and opened the breakers, thereby cutting the power supply.

---

<sup>5</sup> The location of UPS units could not be identified from the alarm log.

The emergency generator did start automatically but did not connect to the grid, as the reverse power protection was activated and automatically opened the breaker for the emergency switchboard. This means that although the emergency generator was running, it was not able to supply the emergency switchboard.

As mentioned previously, propeller pitch controls were supplied directly from the 24V switchboard/UPS connected to the emergency switchboard. The loss of propeller pitch input on the VDR and the crew's experience of failing controls indicate that the 24V switchboard/UPS did not supply power by battery. It is uncertain why the 24V switchboard/UPS failed. Several fuses had burnt and been replaced during the crew's troubleshooting, and it has not been possible to verify which. It is plausible that the power supply failure from the 24V switchboard/UPS was caused by a burnt battery fuse.

13:27:02 -  
13:27:15

Low frequency alarm was issued for the main generator, Diesel Generator 1, indicating that the generator did not supply the main switchboard at the correct frequency. It is not possible to determine the cause of the low frequency. At this point, the 24V service, including control voltage for the Diesel Generator 1, had been cut for more than one hour, and auxiliary systems such as compressors and fuel pumps might have been affected by multiple failures on the power supply system. Seconds after the low frequency alarm, trip alarms for two bus-tie breakers on the main switchboard were issued, followed by a blackout alarm on the main switchboard and a trip alarm for diesel generator 3. At 13:27:12, low frequency alarms for all three diesel generators were issued, and at 13:39:50 the diesel generators shut down. The port main engine shut down automatically, while the starboard main engine had to be manually shut down, as the controls were lost. With no voltage on either the main switchboard or the emergency switchboard and the main engines and diesel generators stopped, the ship was in a dead ship condition.

### **Detection of electrical system failure**

Based on witness statements from the crew, it could be established that the bridge team experienced the failure of navigational equipment from 1222, 7 minutes after the first fire detection alarm sounded at 1215. The GPS stopped updating its position; AIS information became unavailable; rudder indication was lost; and propulsion controls ceased to work. The engine crew was to some extent aware of these issues, as they took over the controls for the propulsion in the engine control room and operated them on the orders of the master. However, in the initial stage of the accident, the malfunction of bridge equipment was merely perceived as operational interruptions and was not investigated, as both the bridge and engine teams were busy handling the fire situation.

From 12:18:09, the alarm monitoring system started to be flooded with internal alarms, and at 12:18:23 the general alarm was raised. At 12:18:21, the trip alarm was issued for the 24V switchboard/UPS located in the emergency generator room, and, four minutes later at 12:22:11, alarms signalled that UPS units were activated. Both the trip alarm and the UPS battery-on alarm were acknowledged. In the period between the trip alarm and the UPS on-battery alarm, 294 alarm entries were issued and presented on a monitor with 37 alarms visible at a time (Figure 44).



Figure 44: Monitor for alarm monitoring system.  
Source: DMAIB

This means that the alarms were visible on the monitor for an average of 30 seconds, during a stage of the accident where the general alarm had just been raised and the engine team was busy mustering and subsequently starting drenchers and isolating the electrical power in the fire area. This explains why the alarms were acknowledged in the engine control room but were not recognized cognitively by the engine crew at this stage.

The engine crew became aware of the power supply failure as they started to lose indications for the engines. This brought the engine crew's attention to the main switchboard panel, where two small indicator lamps were lit to signal that the emergency generator was running and 24V UPS batteries were discharging (Figure 45).

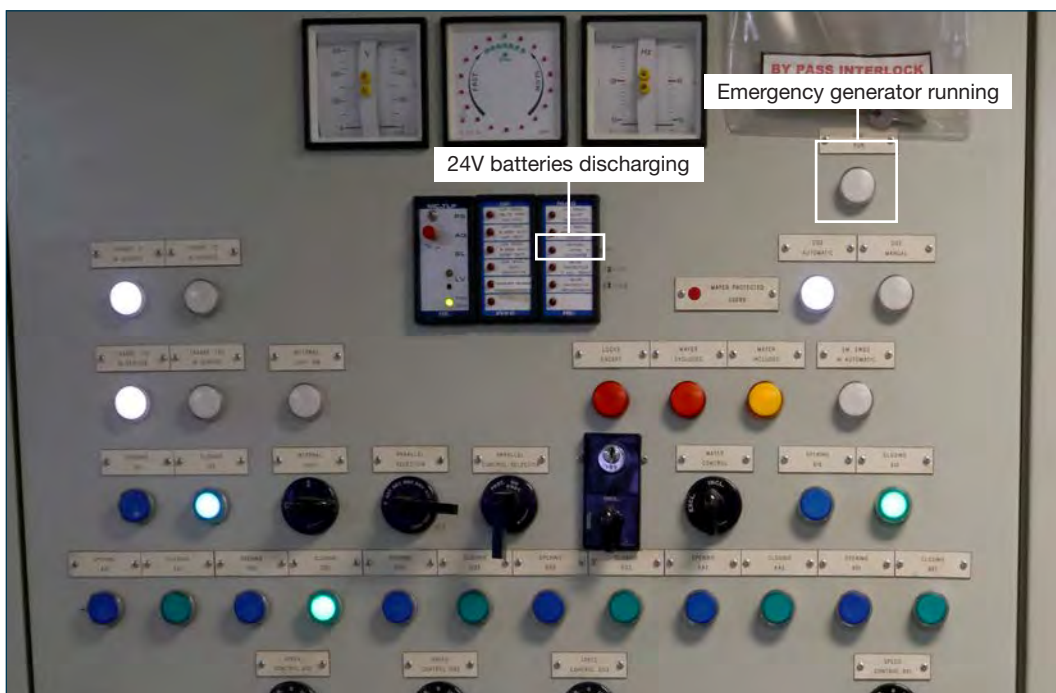

Figure 45: Indicator lamps on main switchboard panel.  
Source: DMAIB

The engine crew then examined the 24V switchboard/UPS in the engine control room and established that the indicator lamps were signalling that the UPS unit was not supplied from the emergency switchboard (Figure 46).

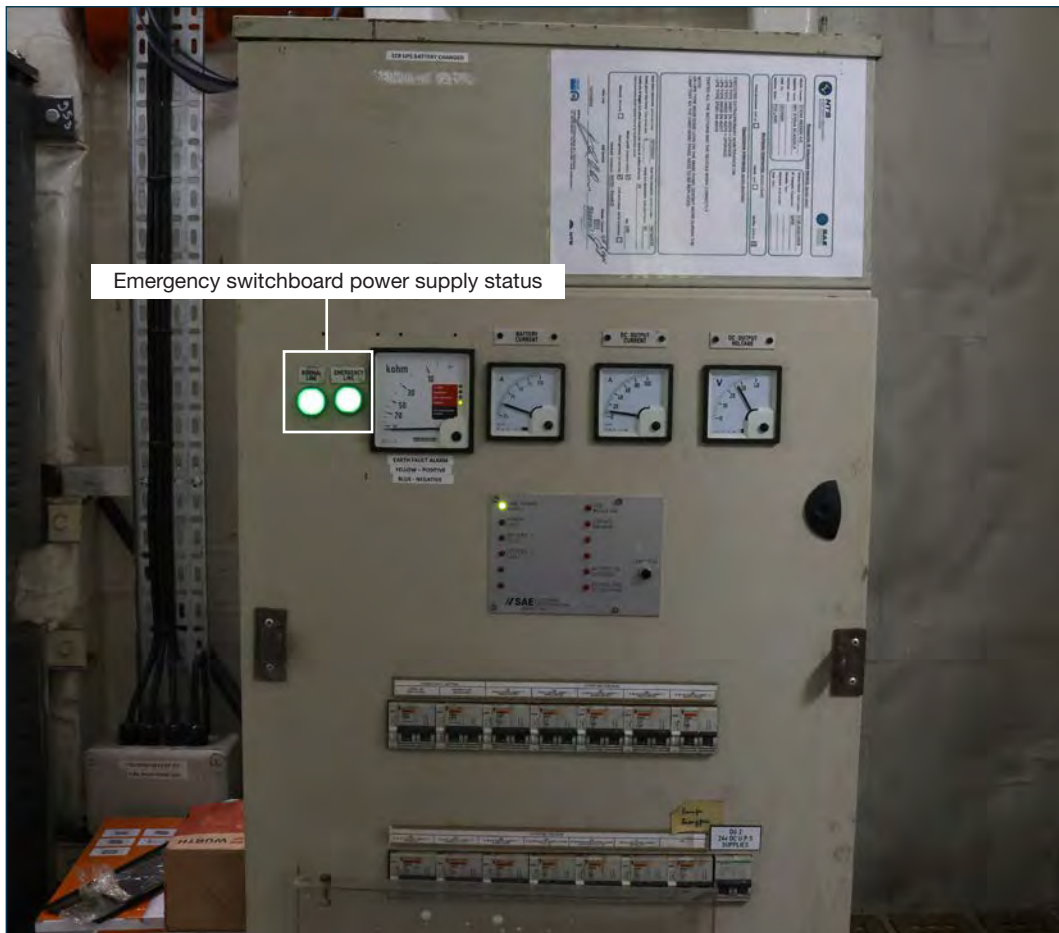

Figure 46: Indicator lamps on 24 V switchboard/UPS located in engine control room.  
Source: DMAIB

When this problem was detected, the chief engineer called the bridge to enquire if it was possible to stop the main engines and was informed that the engines had to keep running. From VDR recordings, it was established that this conversation occurred at 1315. Based on this, it is assessed that the engine crew detected the power supply failure approximately 45 minutes after the first alarm was issued for the 24V switchboard/UPS in the emergency generator room.

The ETO went to investigate why power was not supplied from the emergency switchboard. He quickly scanned the two 220V/UPS panels, where there was a line diagram with indicator lamps signalling that the UPSs were not powered from the emergency main switchboard. He also saw that the breaker for connecting the emergency generator to the emergency switchboard was open, and he attempted several times unsuccessfully to manually close the breaker. He did not have time at this point to investigate further, as firefighters on Deck 4 reported that sparks were still coming from Deck 4. This meant that he had to return to the engine control room to isolate further and discuss the emergency switchboard failure with the chief engineer. When he reached the engine room, the black-out occurred at 1332. By this time, the situation had changed from avoiding a blackout to restoring power from a dead ship condition.

# Restoration of power

## Procedures and checklists for power failure

STENA SCANDICA's ship operating manual (SOM) contained one procedure and one checklist concerning blackouts: "Blackout restart procedure" and "BLACK OUT - and Equipment Restore Check List". The procedure was filed in a section of the SOM comprising engine procedures. The "Blackout restart procedure" presented a list of equipment needing to be restarted or reset following a blackout. The "BLACK OUT - and Equipment Restore Check List" was filed in a different section of the SOM, compiling all checklists. The "BLACK OUT - and Equipment Restore Check List" contained directions on immediate actions to take in the event of a blackout, such as "Call Master to bridge", "Assess traffic situation", "Use emergency telephone to get situation update from ECR", and listed equipment requiring reset or restart.

Additionally, a plastic folder labelled "Blackout procedures" was stuck to a panel in the engine control room (Figure 47).

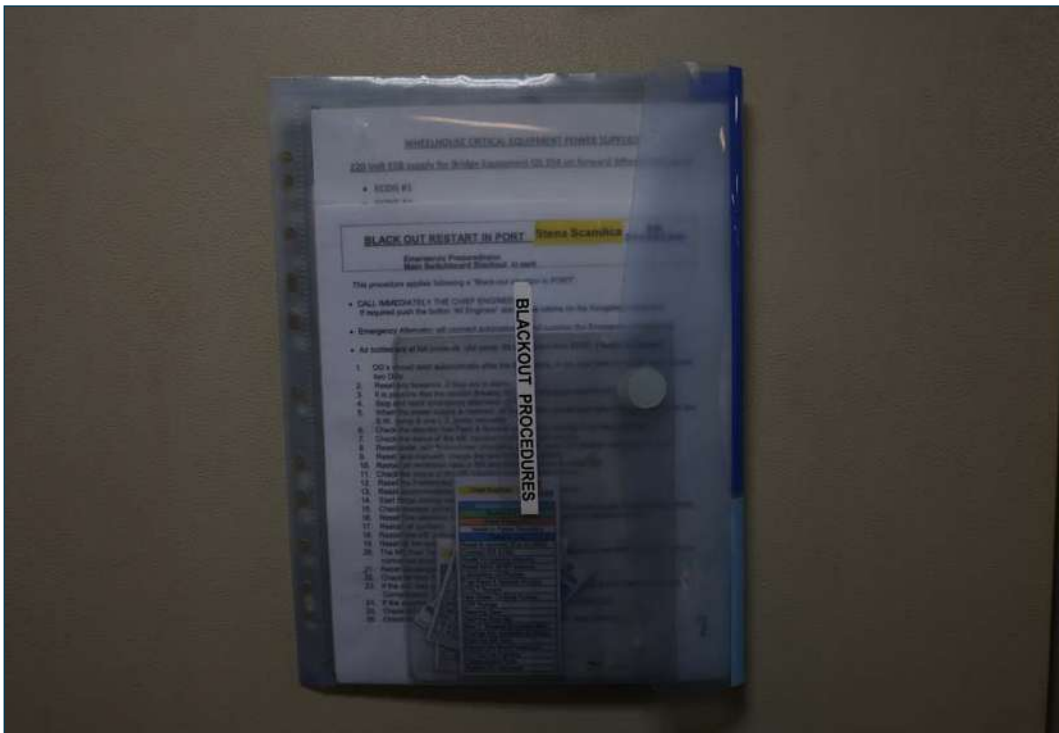

Figure 47: Folder with blackout procedures found in the engine control room.  
Source: DMAIB

These blackout procedures were not included in the ship's operation manual. The folder contained, among other things, a laminated procedure entitled "Black out at Sea". The procedure comprised a list of 29 step-by-step directions of actions to restart the ship.

Common to the blackout procedures and the checklist was that they were written on the assumption that the emergency power supply would be working as intended:





### Response #1

The ETO opened all breakers to isolate the emergency switchboard from all services and ensure that breaker 901 did not trip due to short circuits or overload from burned cables. He then attempted to close the circuit breaker manually by operating the switch for breaker 901 on the emergency switchboard panel (see Figure 49). The breaker kept tripping, and therefore preventing the emergency generator from supplying the switchboard. The ETO realised that, as the cables connecting the emergency switchboard to the equipment and services in the engine room were damaged by the fire, it was impossible to re-establish the power supply from the emergency switchboard to the engine room.

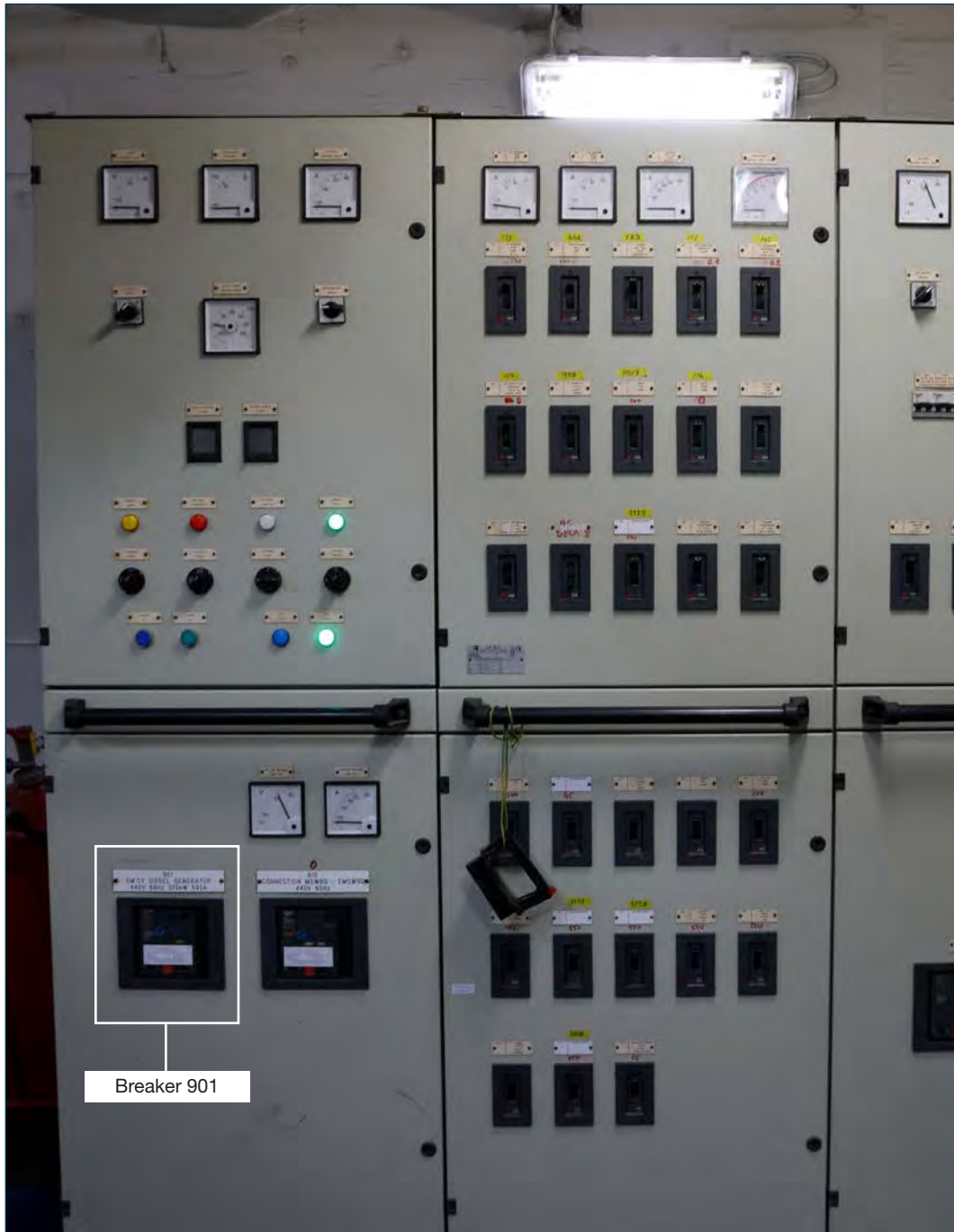

Figure 49: Breaker 901 on the emergency switchboard for emergency diesel generator.  
Source: DMAIB

### *Problem #2*

Restarting the generators in the engine room to recover voltage on the main switchboard required 24V service, which was normally provided from the emergency switchboard. Without power supply from the emergency switchboard, it was not possible to restart the generators.

### *Response #2*

The ETO and the chief engineer decided to jump-start a diesel generator in the engine room by supplying it with 24V using batteries. They went to the battery room, where they assessed that the UPS batteries for the 24V switchboard/UPS most likely had discharged and that the 220V UPS batteries were too dangerous to handle under stressful circumstances. Therefore, they decided the only option was to disconnect the two 12V batteries on the GMDSS. The batteries were then connected in series to provide 24V for the generator.

### *Problem #3*

The ETO and the chief engineer realised that the diesel generator could not be started without air pressure and that they had to restore power supply for a compressor.

### *Response #3*

The only option for starting a compressor was by restoring the 440V power supply for emergency services in the engine room, which included the emergency compressor. The 440V emergency service was supplied from breaker 913 on the emergency switchboard. Therefore, the ETO and the chief engineer realised that voltage on the emergency switchboard had to be restored so they could attempt to only close breaker 913, in the hope that this line was undamaged by the fire and would not short circuit. However, this required them to manage to get the emergency generator online.

### *Problem #4*

Breaker 901 had protection functionalities for reverse power and generator overload. During the ETO's attempt to manually close breaker 901 he observed that the reverse power protection activated and caused breaker 901 to trip, preventing the emergency generator from connecting to the emergency switchboard. The reverse power protection tripped the breaker continuously, though it was reset several times and all consumers were disconnected on emergency switchboard.

### *Response #4*

As there was no voltage on the emergency switchboard, the ETO concluded that the reverse power protection reacted to a faulty signal and decided to deactivate the reverse power protection by cutting the line for the auxiliary relay that put reverse power protection into effect. The reverse power protection logic is presented on the next page (Figure 50), and the line the ETO cut is marked with a red cross. Cabinet containing reverse power protection is shown on Figure 51.

Once the reverse power protection was deactivated, breaker 901 was closed and the voltage on the emergency switchboard was restored. The ETO closed breaker 913 for 440V emergency services and observed that the line was undamaged. The emergency compressor started to build up air and, approximately one hour after, a diesel generator could be started.

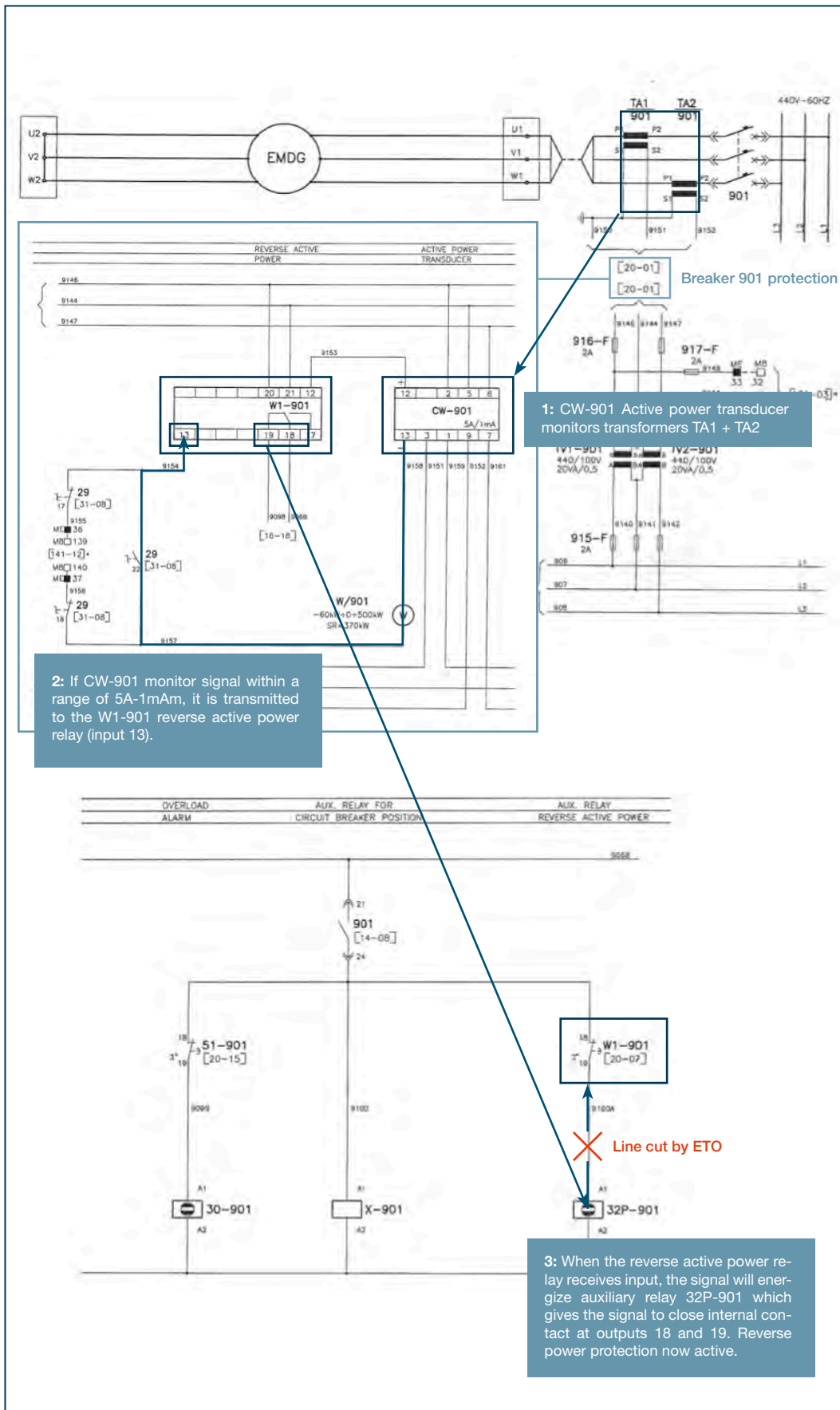

Figure 50: Reverse power protection logic.  
 Source: Stena Rederi A/S, modified by DMAIB

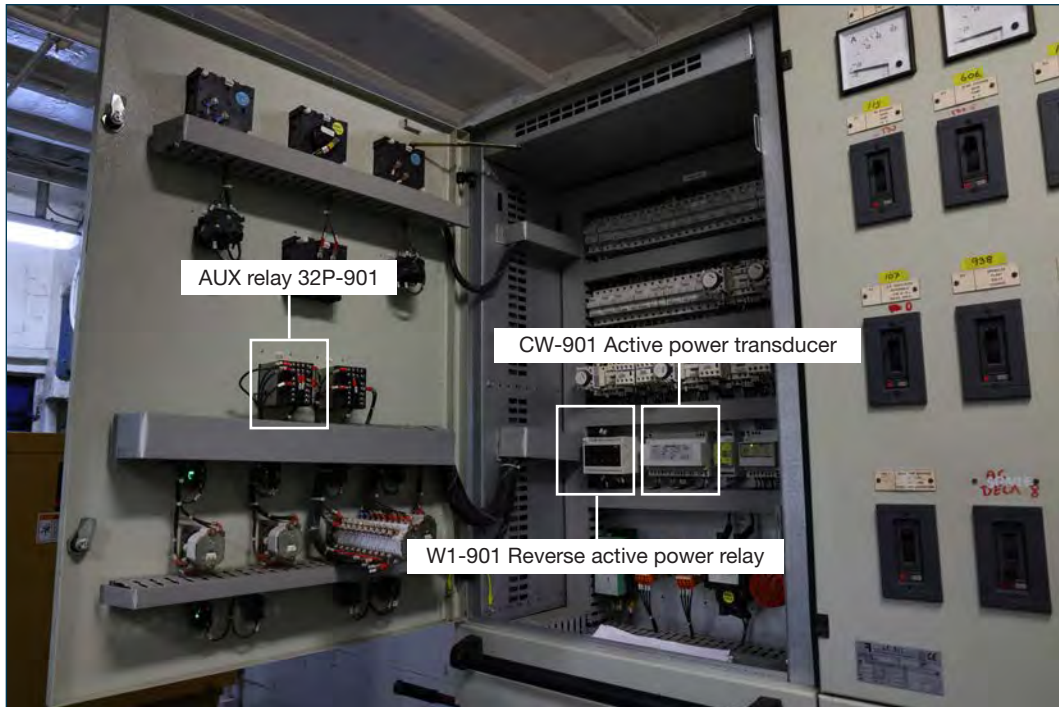

Figure 51: Reverse power protection units in emergency switchboard cabinet.  
Source: DMAIB

#### Problem #5

After the diesel generator was started, the engine crew initiated an attempt to start the port main engines. Restart of the port main engines required 24V service and 220V emergency service from the emergency switchboard. At the emergency switchboard, the ETO concluded that though the cable for 24V service to distribution board 1 was grounded, it was possible to establish power supply on this line. The cable to distribution board 2 short-circuited due to cable damage and was not operational (Figure 52). Also, the cable providing 220V was damaged and not operational.

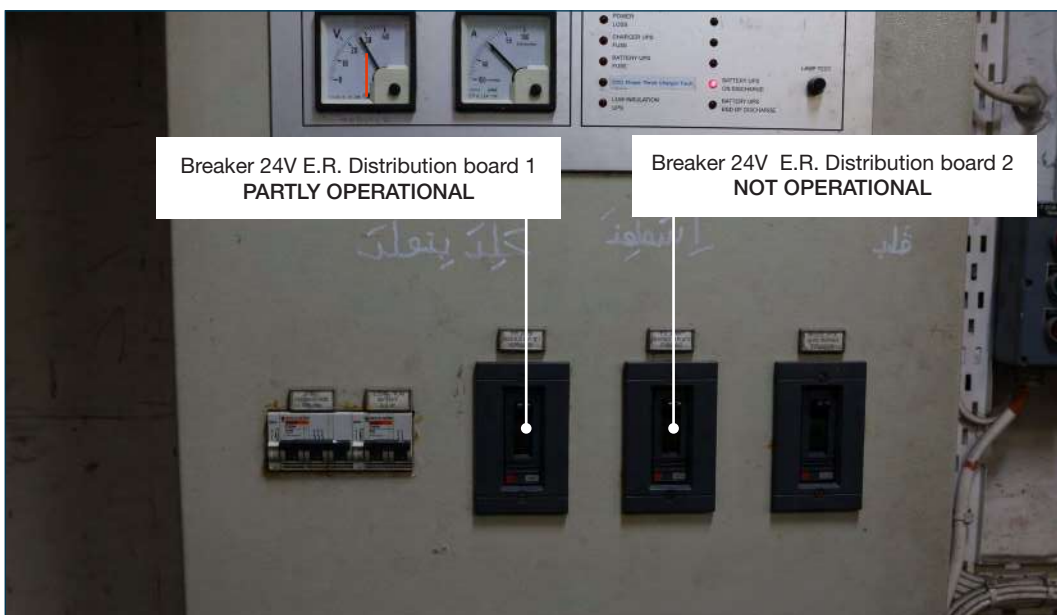

Figure 52: 24V switchboard/UPS in emergency generator room.  
Source: DMAIB

**Response #5**

In the engine room, the ETO bypassed distribution board 2 and connected the services that were necessary for the restart of the engines to distribution board 1 (Figure 53). Furthermore, the distribution board for 220V emergency services was bypassed by supplying the services from adjacent 220V light distribution boards (Figure 54). When 24V and 220V supplies were provided in the engine room, it was possible to restart the main engines and restore power supply to the main switchboard.

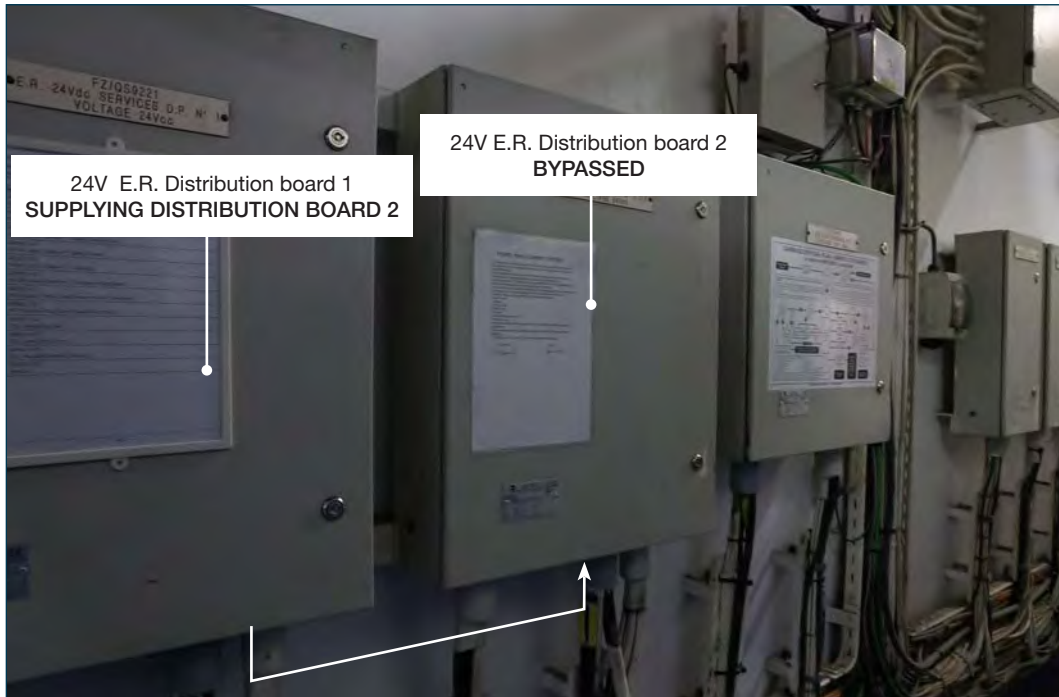

Figure 53: Distribution board for 24 V services in engine room bypassed.  
Source: DMAIB

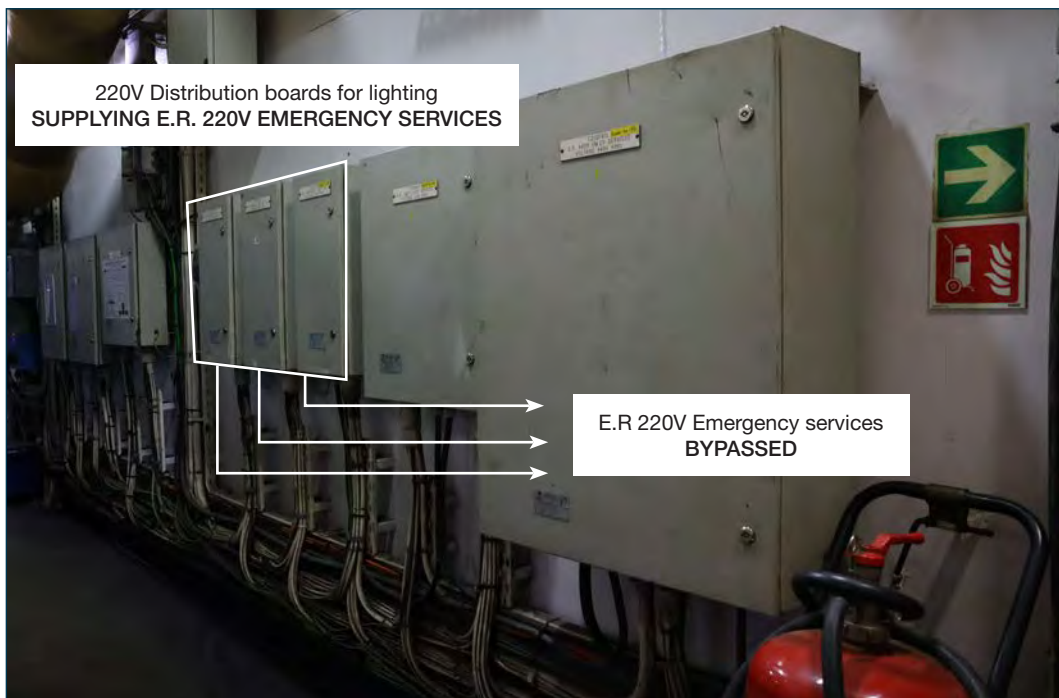

Figure 54: Distribution board for 220V emergency services in engine room bypassed.  
Source: DMAIB

### *Problem #6*

On the bridge, equipment running on 220V was not operational due to a failure on the 220V supply from the emergency switchboard.

### *Response #6*

When the main engines were restarted, the ETO was asked to look into whether it was possible to restore the power supply to the bridge equipment. As the ETO started to investigate the problem on the emergency switchboard by operating the breaker and examining transformers, a second power supply failure occurred on the emergency switchboard, resulting in a second blackout. The ETO and the chief engineer figured that the loss of voltage on the emergency switchboard most likely occurred as a result of the ETO's attempt to restore 220V service to the bridge. It was therefore decided to cancel further attempts to restore equipment and restart generators and main engines, and to head for port using only the most essential services to operate the ship. The bridge crew managed to navigate the vessel using an iPad, GPS and AIS.

# Key points of the blackout investigation

---

- In case of power supply failure from the main switchboard on STENA SCANDICA, the emergency switchboard would automatically isolate from the main switchboard and independently supply consumers essential for the continuation of directional control of the ship and emergency services. However, if a failure arose on the emergency switchboard, only limited backup power supply was provided by UPS batteries. This arrangement was in accordance with the regulations.
- Cables connecting the emergency switchboard with services in the engine room were contained in the cable trays installed on the deckhead above the burning truck on vehicle Deck 4. The cables were unprotected from heat and flame, and, as their insulation burnt away, the cables grounded and short-circuited, resulting in multiple and simultaneous electrical failures within all parts of the power supply system including the emergency switchboard and the 24V switchboard/UPS in the emergency generator room.
- The crew did not notice the failure on the emergency switchboard until approx. 45 minutes after it occurred. This was due to a combination of the crew being occupied with handling the immediate danger of the fire and the fact that the signals indicating the loss of power from the emergency switchboard were easily overlooked, as the multiple failures flooded the alarm monitoring system.
- The procedures and decision support system for blackout and power restoration did not provide guidance for handling a situation of a major power supply failure affecting multiple power sources, and they relied on the emergency switchboard being operational. Therefore, they were unsuitable for the crew to use during this emergency. Instead, the crew had to rely on their experience and resourcefulness to re-establish the power supply to equipment and services that were essential to the restoration of main power and propulsion.
- The multiple failures on the system created an unclear image of the electrical failures. The crew had to troubleshoot the system by a trial-and-error, which although successful in restoring power, also later resulted in a second blackout.



# **Investigation of evacuation**

### Scope of the investigation

The course of events showed that the master, in collaboration with the company's shore-based emergency team, planned to evacuate families with children and elderly or disabled persons by helicopter, and the remaining passengers by means of the ship's on-board lifeboats.

While the airborne evacuation was partially completed, the seaborne evacuation of the remaining passengers was postponed and later cancelled.

In this section, the ship's means of evacuating passengers are described. Additionally, the abandon ship decision-making process is examined, including the ship's decision support system.

## On-board evacuation system

STENA SCANDICA carried two types of appliances for abandoning the ship: a Marine Evacuation System (MES) and a lifeboat/davit system. In this section, the processes and operational requirements for launching these two systems will be described based on operational manuals, specifications provided by the manufacturers, and company procedures.

### Marine Evacuation System (MES)

MES is a lifesaving appliance enabling evacuation directly into inflated life rafts. MES has been introduced as a replacement for traditional lifeboats with davit launch, and is designed for the rapid transfer of passengers from the upper decks of passenger ships and ferries, directly into life rafts in the water.

STENA SCANDICA was equipped with two Viking Evacuation MiniChute (VEMC) 1.6. MESs were located midships on each side of the ship on Deck 5 (Figure 55).

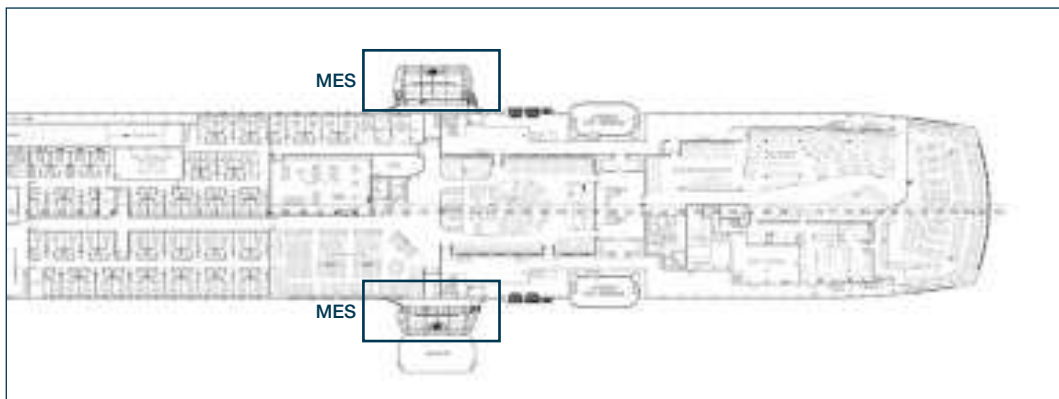

Figure 55: Location of MES on Deck 5.  
Source: Stena Rederi A/S, modified by DMAIB

The MES comprised a life raft, a chute for persons to descend directly into the life raft, and a launch arrangement for releasing and deploying both chute and raft. The chute was a fabric tube formed by a series of funnels with elastic sections to reduce the descent rate during evacuation. The chute was stowed in a container which automatically opened when the life raft was released from the launch arrangement.

The life raft sat on a cradle above the chute container and was released by a crewmember pulling a strap (Figure 56). Once released into the water, the crewmember pulled a painter line to inflate the raft. When fully deployed, the chute would hang vertically along the ship side with the bottom opening connected to the raft (Figure 57). The crewmember operating the system would then position the life raft alongside the ship by winching in a bousing line.



Figure 56: Launch arrangement for MES.  
Source: Viking Life-saving Equipment A/S



Figure 57: Launched MES.  
Source: Viking Life-saving Equipment A/S

The entire system had been tested and certified to meet the requirements of the Life-Saving Appliance (LSA) Code issued by International Maritime Organization (IMO)<sup>6</sup>. According to the certificate, it was possible to launch and inflate the raft, prepare the chute for the descent of evacuees and cut free the life raft within 200 seconds, and to descend 356 persons through the chute within 30 minutes. This was based on tests carried out in port under controlled conditions.

The life raft had a capacity of 101 persons, which meant that additional rafts had to be launched and connected to the chute to utilize the MES's full capacity. Five additional life rafts with capacities of 101, 51 and 25 persons were stowed in an open hold in the ship side near the launch arrangements on starboard and port side. These additional rafts could be connected to the first life raft (Figure 58). In this event, the first raft was used as platform for transferring evacuees to the additional rafts. When deploying the additional life rafts, it was necessary to also deploy the ship's FRB to tow the life raft away from the base raft (Figure 59).



Figure 58: MES with additional raft launched.  
Source: Viking Life-saving Equipment A/S



Figure 59: Additional raft being towed by FRB.  
Source: Viking Life-saving Equipment A/S

The ship's total capacity for evacuation by MES within 30 minutes was 712 persons. The total capacity of the life rafts was 758 persons. The maximum capacity of passengers on STENA SCANDICA was 922, and the maximum number of persons onboard was 1,000. Hence, the capacity of the MES was not sufficient for a fully boarded ship. In that situation, the MES system had to be supplemented by lifeboats.

The LSA Code required that the MES was capable of being deployed from the ship with a trim of up to 10° and list of up to 20° to either side. Furthermore, it should be capable of providing a satisfactory means of evacuation in a sea state associated with a wind of force 6 on the Beaufort scale, which corresponds to a 3 m wave height. The MES certificate or training manual did not present any operational limits for the MES other than a limit of the circumference of evacuees which according to the training manual was not to exceed 2 m, including life jackets. For persons exceeding this limit, an alternative evacuation method had to be used.

A successful launch of the MES required the crew to be familiar with the system. A minimum of two persons were required: a chute leader and a raft operator. If additional rafts were to be deployed, a similar number of additional raft operators were required.

---

<sup>6</sup> International Maritime Organization. Life-Saving Appliances - Including LSA Code. 2017.

The task of the chute leader was to: launch the chute; activate the light signals; operate the bowsing winch to position the inflated raft; prepare the chute for transfer of persons; give orders to the raft operator(s); ensure that the passengers were fit and correctly equipped to descend; ensure that the passengers descended at appropriate intervals; and cut the raft's lines and lashings once the raft was full.

The tasks of the raft operators was to: descend the chute first; connect the chute to the raft with a strap; receive and direct the evacuees; and cut the bowsing lashings. If additional rafts were to be deployed, the additional raft operators were to release the rafts, haul them alongside the base raft, fit a passage sheet between the rafts and help the passengers onboard.

These tasks required the crew to be able to locate and utilise essential equipment and carry out specific actions in a specific order at the right time.

Abandon ship drills were carried out weekly, and it was required that every crewmember participated in at least one of these drills monthly. According to the Muster and Drills procedure (SMM-0243), each abandon ship drill had to include:

- *“summoning of passengers and crew to muster stations with the alarm required by regulation 6.4.2 followed by drill announcement on the public address or other communication system and ensuring that they are made aware of the order to abandon ship;*
- *reporting to stations, incl. MES stations and preparing for the duties described in the muster list;*
- *checking that passengers and crew are suitably dressed;*
- *checking that lifejackets are correctly donned;*
- *lowering of at least one lifeboat after any necessary preparation for launching;*
- *starting and operating the lifeboat engine;*
- *operation of davits used for launching life rafts;*
- *a mock search and rescue of passengers trapped in their staterooms;*  
*and*
- *instruction in the use of radio life-saving appliances.”*

According to the procedure, the part of the abandon ship drill concerning the MES should include *“exercising of the procedures required for the deployment of such a system up to the point immediately preceding actual deployment of the system”*. In practice, this meant that the weekly drills concerning MES were theoretical table-top exercises based on the launch process described in the training manual. MESs are large systems which the crew cannot pack and prepare for use themselves. This had to be done by a certified company. Therefore, exercises with live MES deployment were rare, and crewmembers had few opportunities for hands-on training with deploying the chute and rafts.

The Muster and Drill procedure required that *“Every system party member shall, as far as practicable, be further trained by participation in a full deployment of a similar system into water, at intervals of no longer than two years, but in no case longer than three years”*. On STENA SCANDICA, the port MES was last deployed in February 2018 and the starboard in March 2020. No crewmember had had hands-on experience with launching, operating and potentially troubleshooting the ship's MES during the previous two years.

The training manual comprised 61 pages of instructions. Although the instructions were illustrated to aid the understanding of how the system was operated and the work tasks of specific persons, it would not be feasible to seek guidance in the manual during the launch of the MES in an actual abandon ship situation. Therefore, the correct deployments of the MES mainly depended on the memory of crewmembers and their theoretical knowledge of the launch process.

The ship's training regime with MES was in accordance to the provisions laid out in Order on Notice B from the Danish Maritime Authority, the construction and equipment, etc. of ships<sup>7</sup> D (Notice B, Chapter III, Part B, Requirements for ships and life-saving appliances).

## Lifeboats

STENA SCANDICA was equipped with two lifeboats located in the vicinities of the MES on deck 5 (Figure 60). The lifeboats were stored in a launching appliance which consisted of a davit and a winch (Figure 61). The lifeboats and their launch arrangements were manufactured by Schat-Harding A/S and serviced by Palfinger Marine.

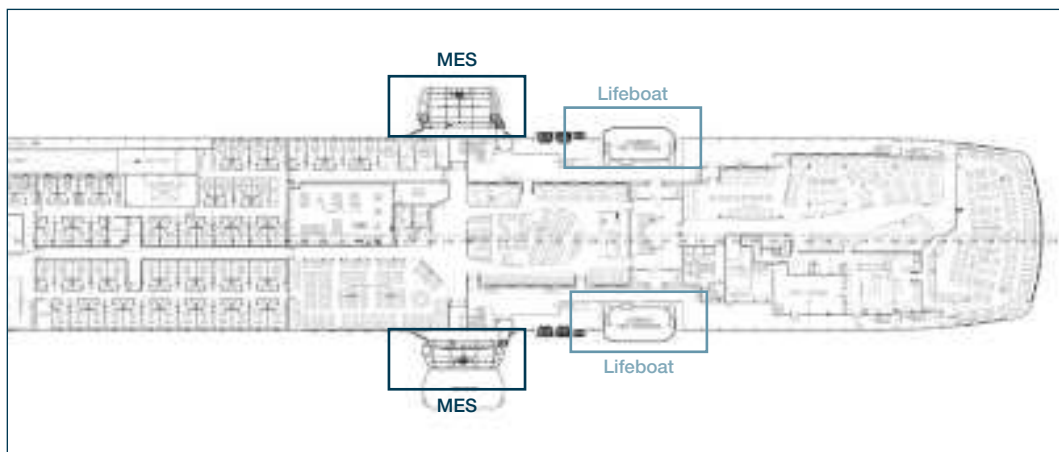

Figure 60: Location of life boats on Deck 5.  
Source: Stena Rederi A/S, modified by DMAIB

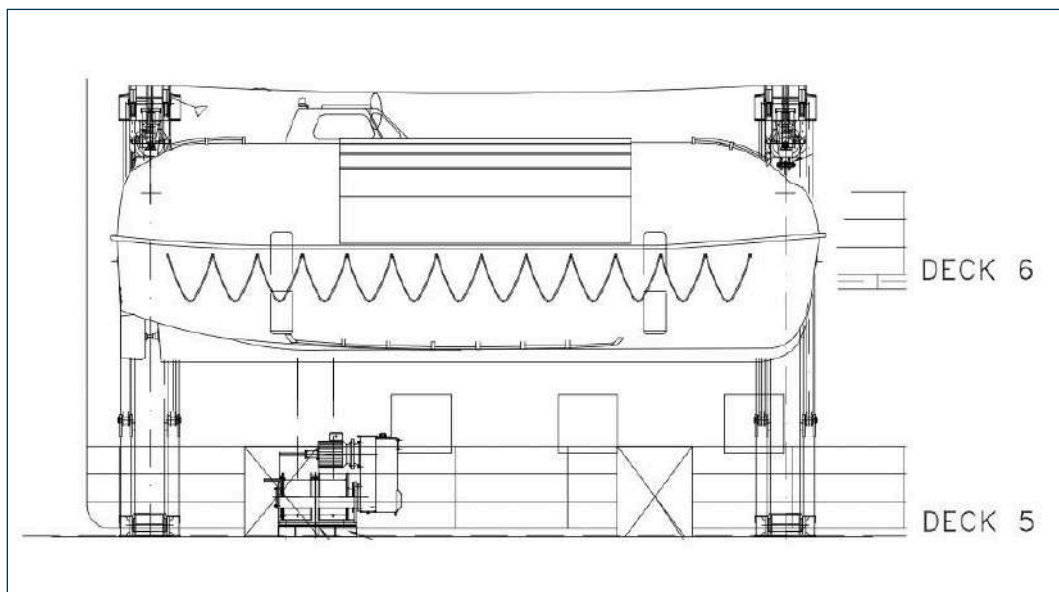

Figure 61: Life boat with davit launch arrangement.  
Source: PALFINGER, modified by DMAIB

<sup>7</sup> Order no. 1512 of 8 December 2016, issued by the Danish Maritime Authority

The lifeboats were of the type MPC32, which was a partially enclosed lifeboat with capacity of 150 persons. The hull construction was of reinforced fiberglass laminate, fabricated and designed to withstand the stresses encountered in an open sea environment, and it was fitted with buoyancy tanks to keep the lifeboat afloat on an even keel in the event of hull damage below the waterline.

Three crewmembers were necessary for launching a lifeboat: One crewmember was to be in charge and manoeuvre the lifeboat, and two crewmembers were to operate bilge pumps, painter lines and hook links. The process of deploying the lifeboat during an abandon ship situation was to use the davit to swing the lifeboat over the ship side and lower it from the stowage position to the embarkation position at deck level (Figure 62).

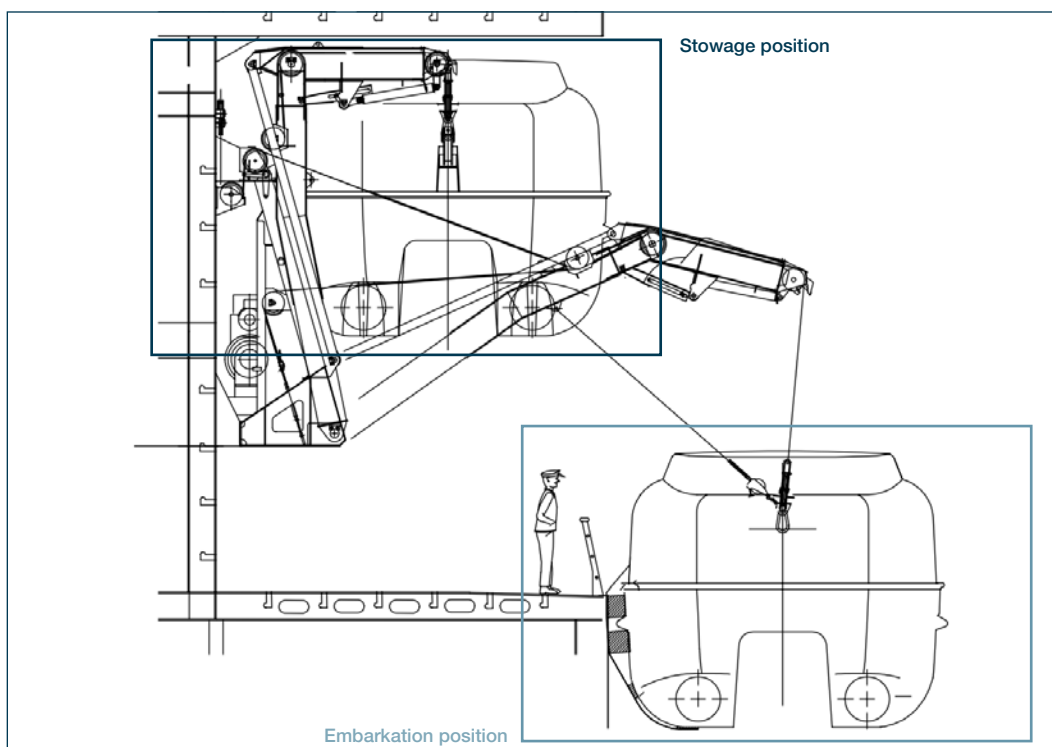

Figure 62: Stowage and embarkation positions.  
Source: PALFINGER, modified by DMAIB

At this position, evacuees and lifeboat operators could board the lifeboat through the side hatch. When fully boarded, all hatches were closed and the lifeboat engine started. Under controlled conditions, the lowering of the lifeboat was carried out from deck level using an electrical motor to winch down the lifeboat. In an emergency, the winch brake could be disengaged from deck level, allowing the lifeboat to be lowered using gravity alone.

When reaching the sea level, the lifeboat crew had to release the hooks connecting the boat to the davit wires. The primary method for releasing the hooks was an off-load release when the lifeboat was fully waterborne (Figure 61). The secondary method, which was only to be used in case of a system failure, was to release the lifeboat while its load was still on the hooks.

The launch process of the lifeboat required the crew to be familiar with operating various lines, lashings, winches and hooks. According to the Muster and Drill procedure, the weekly abandon ship drill had to include: "lowering at least one lifeboat, starting and operating the lifeboat engine, operating the davits used for launching life rafts". This meant that the crew had frequent hands-on experience with operating the launch systems for the lifeboat.

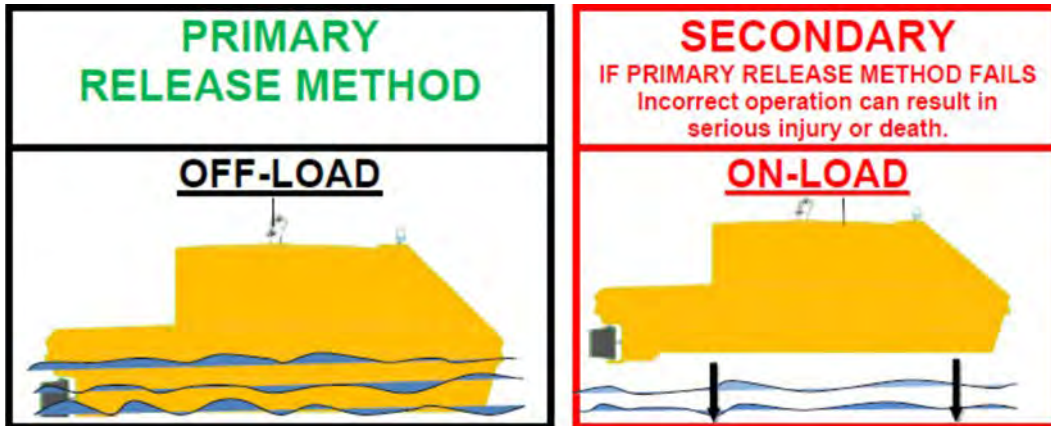

Figure 63: Hook release methods.  
Source: PALFINGER

The launching arrangement was designed to be operated and reset by the crew themselves. However, the operation manuals for the lifeboat and hook emphasise that incorrect operation of the equipment could lead to premature hook release, resulting in the lifeboat dropping from height. The concern about failure of the lifeboat launch system was reflected in the procedure for Life Boat Launch for Drills/Test (SOM-2301), which emphasised that, during drills or tests, the lifeboat had to be lowered without persons on board before repeating the lowering process with persons on board.

As for the MES, the LSA Code requirements stated that the lifeboats had to be capable of being safely launched under all conditions of trim of up to 10° and list of up to 20° to either side.

## Decision to evacuate by onboard evacuation system

---

The company's Abandon Ship Procedure (SMM-0229) stated the following:

*"The decision to abandon the ship is usually a consequence of another emergency and shall only be made when staying on board is thought to be more dangerous than to evacuate. The following shall be taken into consideration:*

- *Status of the ship;*
- *Emergency conditions;*
- *Weather conditions.*

*Based on these considerations, it will be decided whether partial evacuation or abandonment of the ship is required. Abandon ship procedure to commence only on the verbal authority of the Master".*



From the quote above, two observations are made concerning the decision to abandon the ship:

- The procedure acknowledges that abandoning the ship is a safety-critical operation which presents a danger to passengers. The decision to abandon ship entails an assessment of whether staying on board the ship presents more danger to the persons on board than using the MES and lifeboats.
- The master is the only person authorised to set the procedure in motion once the decision has been made.

On STENA SCANDICA, the initiative to start planning for evacuation of the ship was taken by the company's shore-based emergency team. At 1716, they called the master and asked him to decide how to evacuate the ship and set a deadline for when evacuation should be initiated. At this point, the ship had been drifting without propulsion for almost four hours, and it was estimated that the ship was a further four hours away from grounding. At the time, the sea state was rough, with a 2-3 m wave height and winds of between 15-20 m/s. The master decided that the passengers were to be evacuated by means of the lifeboats and that the evacuation procedure was to be initiated at 1900, while there was still daylight.

The decision to use lifeboats was based on the master's assessment of which evacuation system would present the least danger to the passengers and which was most reliable. The master was of the opinion that the two evacuation systems had advantages and disadvantages, which he had to take into account.

MES had the advantage that the descent from deck to sea level by means of the chute protected the passengers from the danger of falls from height, and the launch of the MES was fast if only one raft was to be launched. However, more rafts were needed to accommodate all the passengers and crew, which complicated the launch operation. The master had witnessed and participated in several MES deployments, and his personal experience was that difficulties always arose that complicated the launch, despite taking place in controlled environments. As the crew had little hands-on experience with deploying the MES and with the prospect of having to do it in a stressful situation and in rough seas, the master doubted their ability to conduct a successful launch. Furthermore, the master was concerned about how the rafts would perform in rough seas and whether there might be risk of puncturing the rafts if they made contact with the rescue vessels.

The lifeboats had the advantage that the crew was familiar with the launch operation, and the master believed that the hull construction of the lifeboat would better protect the passengers in the rough sea state. Furthermore, the lifeboats were self-propelled, which reduced the necessity of having to transfer passengers to other ships or helicopters while at sea. The chief concern about using the lifeboats was the danger of falling from heights if the launch operation failed due to either equipment malfunction or incorrect operation. The release of the hook in rough seas, where the wires would continuously shift between being on and off tension and crewmembers could get hit by the hooks when loosened, was a further consideration. The master was also concerned about the lifeboats slamming against the water surface, due to the ship's roll, pitch, heave and yaw, as they were lowered, which could result in damage to the boat and/or injuries to persons on board.

Both evacuation systems presented serious dangers to the passengers, and the master therefore preferred to delay the evacuation as long as possible in the hope that the propulsion was restored.

At the time, when the master was asked to plan for evacuation, the emergency generator was online on the partially operational emergency switchboard, and one diesel generator had been restored.

A decision support system (DSS) was available to the crew for different emergency scenarios, which consisted of checklists in hard copy divided into three sections:

- Initial actions (mandatory and cannot be changed)
- Subsequent actions/considerations (mandatory and cannot be changed)
- Ship-specific actions/considerations (can be used by the vessel if there are ship-specific actions/considerations not covered by the initial/subsequent actions).

The checklists served as aides-memoire of the actions to take, but they did not support decision-making per se. In addition to the checklists, the DSS contained a triage for determining the severity of a given incident (Figure 64).

	Date & Time	No. Persons On Board	No. of injured persons on board
	GREEN	YELLOW	RED
THREAT GENERAL	The vessel (is safe and) can be assumed to remain so.	The vessel is currently safe, but there is a risk that the situation will get worse.	The level of safety aboard has significantly weakened and immediate external action is required to ensure the safety of the people aboard. The vessel is no longer safe.
FLOODING	Flooding affects a limited or contained space and has no effect on the vessel's stability and seaworthiness.	Flooding can be kept under control with pumps and watertight compartments, but the seaworthiness of the vessel is restricted.	Extensive flooding or progressive flooding to undamaged watertight compartments. Flooding cannot be kept under control and poses a direct danger on the entire vessel.
LISTING, DECREASE OF STABILITY	Listing or decrease of stability does not affect the seaworthiness of the vessel. Listing is small (less than 7° for passenger ships) and stability is good.	Seaworthiness of the vessel is restricted due to a decrease of stability or a notable list. Notable listing but sufficient stability. There is still enough time for orderly evacuation and abandonment of the vessel.	Large heel angles. The seaworthiness of the vessel is significantly impaired, its stability is threatened and there is an imminent need to evacuate. Vessel has extensive listing the heel angle is more than 15°.
DECREASE OF MANOEUVRABILITY	Vessel's manoeuvrability is hampered, but the vessel can still proceed on its course.	Vessel has lost its manoeuvrability, but is still capable of emergency anchoring or drifting safely.	Vessel has lost its manoeuvrability and is not capable of emergency anchoring or drifting safely.
BLACK-OUT	Functions important for ship operations are kept running by backup systems while the fault is repaired.	Operational capability of the vessel is limited: backup systems do not work as planned or functions important for ship operations are kept running by backup systems, but the fault cannot be repaired at sea.	A full black-out of long duration that cannot be repaired at sea poses a direct danger on the entire vessel.
FIRE	Fire has been extinguished and there is no danger of reigniting and/or the consequences of the fire do not affect the vessel's safety.	Fire or explosion affects only a limited area and can be brought under control with the vessel's own or external damage control/firefighting resources.	Fire cannot be kept under control or the consequences of an explosion pose a direct danger on the entire vessel or the persons on board.
DANGER POSED BY HAZARDOUS SUBSTANCES/ DANGEROUS GOODS	Release of hazardous substances on board does not pose any danger on the vessel.	Release of hazardous substances on board poses a danger in certain sections of the vessel, but the release can be contained to these sections.	Release of hazardous substances on board poses a direct danger on the entire vessel.

Figure 64: Triage for assessment of incident severity in the ship's decision support system. Source: DMAIB

However, the determination of severity was not combined with a set action to take based on the severity. Therefore, it did not guide decision-making with regard whether to abandon the ship or not.

At 1812, the idea of evacuating vulnerable passengers, such as families with children, elderly people or disabled persons, from the ship by means of helicopter was proposed. It has not been possible to establish who initially put forward this idea, but it was agreed upon by the master, the company shore-based emergency team and Swedish Rescue. At 1852, the first helicopter arrived at STENA SCANDICA and started hoisting passengers off the ship.

Although the deadline for evacuating the passengers by lifeboat was reached soon after, it was not initiated for two main reasons:

- The engine crew was preparing to start the main engines, and
- Swedish Rescue advised against launching the lifeboats due to increasingly deteriorating sea state. No rescue boats or coastguard boats were able to get alongside STENA SCANDICA due to the risk of contact damage.

At 2007, propulsion was confirmed to be working. At this point, the ship was 3.5 nm miles from the shore and approximately 1.5 hours from grounding.

At 2043, the anchors were heaved, and the STENA SCANDICA altered course away from the coast of Fårö. At this point, Swedish Rescue suggested stopping the helicopter evacuation, as propulsion was regained, but also due to darkness and deteriorating weather conditions. The helicopter evacuation was ongoing from 1856 to 2052. 33 out of the planned 69 persons were evacuated within this period. The rate of evacuation by helicopter was 3.5 minutes per evacuee.

## Key points for evacuation investigation

---

- The master's decision to evacuate was based on an assessment of whether it was safer to stay on board given that the evacuation process could expose the passengers to danger.
- The on-board decision support system did not offer guidance for the master in the decision-making process on whether to evacuate or not.
- The crew's little or no hands-on experience with live launch of the MES and the concerns about the rafts' performance in rough seas made the master favour evacuation by lifeboats when planning the possible evacuation. This option was only feasible as the number of persons on board was only one-quarter of the ship's capacity on the day of the accident.
- The master set the deadline for evacuation to ensure that it could be carried out during daylight. The seaborne evacuation was postponed beyond the deadline, due to the prospect of restoring propulsion. Evacuation of vulnerable passengers by helicopter was initiated within the deadline; however, less than half of the planned number of persons were evacuated before darkness.

# Analysis

## The fire on Deck 4

---

The fire was ignited and developed on the left side of the gap between the truck and trailer. In that area were a number of different sources of ignition but the investigation did not conclusively establish the primary cause of ignition. Subsequently, the fire spread to the truck's cab and trailer. The fire was detected by optical fire sensors in the early stages of the fire, and the crew activated the drenchers within 15 minutes to contain the spreading of the fire. While the drenchers were activated, the firefighters searched to locate and extinguish the fire. Few vehicles were stowed in the area of the burning truck, which offered optimal conditions for the firefighters to move around on the vehicle deck with pressurised fire hoses and to establish new connections to fire hydrants near the truck. Therefore, the crew managed to locate and extinguish the fire approximately 30 minutes after it was detected and before it spread to other vehicles or adjacent compartments.

Ro-Ro passenger ships in trade resembling STENA SCANDICA's carry various types of vehicles, e.g., private cars, electric cars, motorcycles and camper vans, which all contain different components that under specific circumstances, such as faults or wear, can constitute fire hazards. It is not possible for the crew to take preventive measures against these fire hazards, which means that fires will occur occasionally. These uncontrollable fire hazards are mitigated by having systems in place to ensure early detection of fires and by having technically reliable fire-extinguishing capacities. However, the fire on STENA SCANDICA brought the reliability of the firefighting systems into question.

While cooling was ongoing, the power supply for both the main fire pump and the emergency fire pump ceased due to a complete blackout, as critical electrical cabling was damaged by the fire. The failure in the power supply did not affect the outcome of the firefighting because the fire was extinguished shortly before. But the effects of the damage to the electrical cabling on Deck 4 posed a vulnerability to the functioning of the ship as a whole. This vulnerability was a result of how the electrical infrastructure was designed.

## Vulnerabilities in electrical infrastructure

---

STENA SCANDICA's power system was designed in accordance with Danish and international regulation, which required an emergency power source, a transitional power source and an emergency switchboard to distribute emergency power in case the main power supply system failed. This meant that the power sources had to have redundancies.

During normal operation, the power supply system located in the emergency generator room was part of the main power supply system and delivered, for example, 24V power supply, which was essential for the operation of the engine room machinery and the bridge equipment. The power supply system was therefore vulnerable to faults on the emergency switchboard and/or the cabling, as the main switchboard was not able to perform independently of the emergency switchboard.

The cabling connecting the main switchboard with the emergency switchboard was thus a critical part of the electrical infrastructure but was not designed with a redundant system.

The cabling connecting the emergency switchboard with the engine room machinery and services was assembled in cable trays that crossed Deck 4, where it sat unprotected below the deckhead. This meant that part of the critical electrical infrastructure was placed in an area where fire could be expected. When the fire broke out on Deck 4, cabling was directly exposed to the fire plume. The cable insulation was not able to withstand the heat impact, and multiple short circuits occurred as the wires were laid bare by the fire and exposed to direct contact with each other, fire and water spray. This resulted in faults on the emergency switchboard and some UPS units, and subsequently a complete blackout as the main engine room lost 24V power supply.

As the cabling was damaged, the possibility to restore power by using the emergency generator was literally cut off until the crew was able to find alternative solutions. Due to the vulnerability of the critical electrical infrastructure, all the ship's safety critical systems, such as steering and propulsion systems, fire-extinguishing systems and deployment of anchors, were immobilised and the ship drifted uncontrollably. These events show that having a redundant power source such as an emergency generator will not suffice to ensure continuous power supply when the power distribution system does not also have redundancy and/or structural protection, particularly in areas where there is significant fire risk such as vehicle decks.

## Troubleshooting and crisis management

---

It is acknowledged that the mental stress load in emergency situations challenges the ability to maintain an overview of the situation and to respond expediently. This has led to mandatory requirements for ships to have emergency procedures in place for different emergency scenarios which are subject to training during drills and exercises. A decision support system is also required to aid masters on what actions to take. The emergency procedures and decision support systems on STENA SCANDICA were standardised documents which target different emergency scenarios on a general level and relied on the emergency systems being in working order. Such standardised documents cannot cover all possible permutations of events and scenarios, and therefore they often fall short in dynamic emergency situations and become less useful for the crew when making critical decisions.

The blackout procedures on board STENA SCANDICA relied on the emergency power system being intact and therefore did not provide support for the ETO and the chief engineer in the troubleshooting process. The restoration of the ship's power and propulsion was therefore entirely reliant on their knowledge of the electrical system, the ability to think up creative solutions in a stressful environment, and the willingness to take bold decisions on removing safety-critical equipment and using them for other purposes, by dismantling protective mechanisms and creating new electrical connections while the events unfolded.

The abandon ship procedure advised the master that the decision to evacuate the passengers had to be based on which scenario presented the least danger to the passengers and crew. The decision support system included a triage for determining the seriousness of emergency situation.

Making a decision based on comparing the dangers of different scenarios is unproblematic in situations where the outcome seems evident, such as an out-of-control fire or an apparent loss of stability.

On STENA SCANDICA, it was not evident what the outcome of the blackout would be. It was uncertain whether the crew would be able to restore propulsion and directional control of the ship before the ship reached the shallow waters surrounding Fårö. On the other hand, the outcome of an evacuation was also uncertain. The decision to evacuate was hence the choice between two uncertain scenarios, and the decision support system could not determine which option would produce the better outcome.

As the engine team worked on restoring equipment in the engine room, the ship was drifting closer to shore. This made the decision to evacuate difficult. The ship was stable while drifting, and the passengers were considered to be safe on board, but, if the ship grounded, the situation could quickly change. Therefore the evacuation had to be made in advance of impact, leaving sufficient time to embark passengers into the lifeboats and launch them. The master was, however, reluctant to transfer the passengers to the lifeboats because the evacuation process could cause serious injuries to persons, as the sea was rough. Consequently, the evacuation by means of lifeboat was postponed beyond the deadline, thereby reducing the possibility of evacuating the ship successfully. Evacuation of vulnerable persons by helicopter was initiated within the deadline, but fewer than half of the persons to be evacuated by helicopter were hoisted off the ship before darkness fell, which was the planned deadline for the evacuation.

The engine team managed to restore propulsion and steering approximately 1.5 hours before a potential grounding. Thirty-three persons were evacuated from the ship and the remaining 198 passengers brought back to Nynäshamn, all unharmed. This was the result of the efforts and bold decisions of the engine team and the master, which are easy to appreciate due to the positive outcome. This outcome was not a given in the critical environment they were operating in.

# Conclusion



# Accident causation

---

On 29 August 2022, a fire broke out in a truck on STENA SCANDICA's Deck 4 due to a fire ignited and developed on the left side of the gap between the truck and trailer. In that area a number of different sources of ignition were observed, but the investigation could not conclusively establish the primary cause of ignition. The fire was quickly detected by the crew, and the fire was extinguished before it spread to other vehicles or compartments. Electrical cables essential for the operation of the ship were damaged by the fire, which resulted in a major failure on the power supply system and caused a complete blackout. The crew was unable to manoeuvre the ship and fully deploy the anchors, and the ship drifted uncontrollably for 6.5 hours towards the shallow waters off the island of Fårö.

While the crew were making efforts to restore power and propulsion, it was planned to evacuate passengers by means of helicopter and lifeboat. Evacuation of vulnerable passengers by helicopter was initiated, while evacuation by lifeboat was postponed as the restoration of power was progressing, and it was deemed safer for the passengers to stay on board. Thirty-three passengers were evacuated by helicopter before power was restored, and the ship returned to port. No passengers or crewmembers were injured.

The investigation found that the fire on the vehicle deck was quickly brought under control and extinguished. However, critical electrical infrastructure with no structural fire protection, or redundancy, was installed below the deckhead above the vehicles and was thereby directly exposed to the fire hazard. The fire therefore resulted in power cables essential to the operation of the ship being damaged. The damaged cables created a cascading effect of major power supply failures, leading to a loss of directional control and immobilisation of safety critical equipment such as fire-extinguishing systems and anchors.

The emergency procedures and decision support system available to the crew were standardised documents that relied on all the emergency systems being in working order. They did not cover the situation experienced on board with multiple system failures, including failure on power backup systems, and did not aid the crew in resolving the situation and taking decisions. The restoration of power therefore relied solely on the crew's skills and their ability to apply their resourcefulness in stressful circumstances and to make difficult decisions based on imperfect information.

## Learning from the accident

---

- Utility of backup emergency power sources depends on an intact power distribution system. To ensure distribution of emergency power, it is important to look at the power system as a whole and identify critical electrical infrastructure such as cabling. To enhance the robustness of the system, critical parts of the electrical infrastructure must be structurally protected or designed with redundancy.
- For many years, accident investigation focused on the shortcomings in human performance as a safety-critical issue. The fire and blackout on STENA SCANDICA highlight the opposite: human skill and adaptability can remedy failures and shortcomings of the ships' systems. This occurs on a daily basis during normal ship operation on a small scale and goes unnoticed. When a major system failure occurs, such as the power supply failure on STENA SCANDICA, where none of the ship's systems are operational, including the emergency system, it becomes apparent that crew members' adaptive capacities in emergency situations are essential for ensuring the safety of the ship.

# Preventive measures

# Preventive measures by Stena Rederi A/S

---

DMAIB has received the following information on preventive measures taken by Stena Rederi A/S following the fire on STENA SCANDICA:

## QUOTE

*“The learnings from this unfortunate incident have been analysed at all levels within our organisation. The senior management has taken a proactive role in order to address the main concerns.*

*Preventive measures implemented:*

- *Identify critical infrastructure such as cabling. Now protected with fire resistant compound application over the cables running through the cargo space on deck 4.*
- *Improved the CCTV system on the vehicle decks.*
- *Refer socket low insulation alarm installed.*
- *Fire detection system upgraded, drencher zone indication added.*
- *Regular drencher pipes thickness measurements with some NDT methods implemented and controlled by the planned Maintenance system.*
- *Update of the Decision Support System.*
- *Review and update od SMS procedures.”*

*Stena Rederi A/S*

# Appendix

## SHIP'S DATA

---

Name:	STENA SCANDICA
Ship type:	Passenger/Ro-Ro Ship
Nationality:	Denmark
Port of registry:	Hellerup
Call sign:	OZNO2
IMO number:	9329849
Year built:	2005
Shipyard/shipyard number:	Cantiere Navale Visentini Srl – Porto Viro/no. 212
Classification Society:	Lloyd's Register
Length overall:	222.08 m
Breadth overall:	25.6 m
Maximum draught:	9.15 m
Gross tonnage:	35,456
Deadweight:	9,670 t
Engine rating:	23,760 kW
Service speed:	23.5 knots
Hull material:	Steel

## VOYAGE DATA

---

Port of departure:	Nynäshamn, Sweden
Port of arrival:	Ventspils, Latvia
Voyage type:	International
Information about the cargo:	Vehicles and passengers
Manning:	58
Number of passengers:	241
Pilot on board:	No

## WEATHER

---

Wind:	14-17 m/s - Northeast
Wave height:	2-3 m
Visibility:	Good
Weather conditions:	Overcast
Light/dark:	Light

## INFORMATION ABOUT THE ACCIDENT

---

Type of marine casualty:	Fire
IMO Classification:	Serious casualty
Date and time:	29 August 2022, 1215 UTC+2
Location:	Baltic Sea
Ship operation:	In passage, mid-water
Place on board:	Vehicle Deck 4
Human factors:	Yes
Consequences:	The ship suffered blackout and drifted uncontrollably.

## **ASSISTANCE FROM AUTHORITIES ON LAND AND EMERGENCY SERVICES**

---

**Parties involved:** JRCC Sweden, Swedish Coastguard.  
**Resources used:** Rescue helicopters and rescue boats.  
**Actions taken:** 33 passengers evacuated from the ship.

## **RELEVANT CREW MEMBERS**

---

**Master:** 40 years old. 22 years at sea in total. 1 year on STENA SCANDICA.  
**Chief officer:** 35 years old. 15 years at sea in total. 26 days on STENA SCANDICA.  
**Chief engineer:** 42 years old. 23 years at sea in total. 6 months on STENA SCANDICA.  
**Electro technical officer:** 29 years old. 4.5 years at sea in total. 1 year on STENA SCANDICA.  
**Bosun:** 34 years old. 14 years at sea in total. 2 years on STENA SCANDICA.

