



# POTENTIAL OF HYDROGEN AS FUEL FOR SHIPPING

BY ABS, CE DELFT & ARCSILEA

EMSA/Hydrogen - 2022/2023 - 4837444

Date: 31/08/2023

### About this study:

This report was commissioned by the European Maritime Safety Agency (EMSA) under framework contract [EMSA/OP/43/2020](#)

### Authors:

Laursen, R.; Patel, H.; Dowling, M.; Sofiadi, D. ; Ji, C.; Nelissen, D.; Király, J.; van der Veen, R.; Pang, E., (2023). Potential of Hydrogen as Fuel for Shipping, American Bureau of Shipping, CE Delft and Arcsilea

### Recommended citation:

European Maritime Safety Agency (2023), *Potential of Hydrogen as Fuel for Shipping*, EMSA, Lisbon

### Legal notice:

Neither the European Maritime Safety Agency (EMSA) nor any third party acting on behalf of the Agency is responsible for the use that may be made of the information contained in this report

### Copyright notice:

The contents of this report may be reproduced, adapted and/or distributed, totally or in part, irrespective of the means and/or the formats used, provided that EMSA is always acknowledged as the original source of the material. Such acknowledgement must be included in each copy of the material.

Citations may be made from such material without prior permission, provided the source is always acknowledged. The copyright policy of EMSA is compatible with the CC BY 4.0 license.

The above-mentioned permissions do not apply to elements within this report where the copyright lies with a third party. In such cases, permission for reproduction must be obtained from the copyright holder.

This report and any associated materials are available online at [www.emsa.europa.eu](http://www.emsa.europa.eu)

© European Maritime Safety Agency 2023

## Executive Summary

The maritime industry faces substantive challenges, many of which are driven by increasingly stricter air emissions and climate legislation as its practitioners navigate a course towards decarbonisation. Among the broad spectrum of technologies and fuel solutions being considered, hydrogen that is produced with renewable energy (green hydrogen) has been identified as a fuel that could offer a 'near-zero' carbon solution on a well-to-wake basis.

While shipping has limited experience using hydrogen as a fuel and some of the key technologies (such as engines) remain under development, there is sufficient land-based experience with its production and use that would serve as a sound basis for the transition to a marine fuel.

There are some barriers, such as hydrogen's low energy density (which would increase the storage needs onboard a ship), the cost of the equipment and significant need to expand the global capacity to distribute and produce green hydrogen. In the end, hydrogen-fuelled vessels may prove to be a more appropriate solution for short-sea shipping rather than deep-sea.

By examining the current production capacity for hydrogen, the existing regulatory landscape, fuel storage options, supply and power generation technologies – along with techno-economic analyses and risk-based case studies – this study has identified the potential for adopting hydrogen as a marine fuel.

### Production

Currently, hydrogen is produced using fossil energy carriers, mostly natural gas. In the future, hydrogen can be expected to be produced on larger scale, using renewable energy. There are four production pathways for green hydrogen: electrolysis (using renewable electricity), direct solar hydrogen production, biomass fermentation and thermochemical biomass conversion. Based on the technological development and the limited amounts of sustainable biomass, the electrolyser technologies are currently considered to be the most suitable, as they produce hydrogen by splitting pure water using renewable electricity. For this reason, this production pathway is seen as having potential to decarbonise multiple industrial sectors. Currently, the global production of green hydrogen is less than 0.1 million tonnes per year. Comparatively, the current global energy demand of international shipping is estimated to be about the equivalent of 95 million tonnes hydrogen per year.

### Sustainability

Well-to-tank GHG emissions of green hydrogen produced by means of water electrolysis are expected to be close to zero, with a small amount coming from the production of electricity generation units and electrolysers. Additionally, the combustion of green hydrogen in marine ships does not directly generate greenhouse gas (GHG) emissions. GHGs are only emitted from the combustion of pilot fuels. However, in case a net zero carbon fuel is used as a pilot fuel, the emissions can be eliminated on well to wake basis. In some cases, burning hydrogen can, however, lead to hydrogen slip. This unburned hydrogen, if released into the atmosphere, is an indirect GHG. Hydrogen may leak from pipelines, from storage tanks during boil-off and venting practices during start-up and shutdown, and during operations to remove fuel impurities. The result of these operational processes may contribute to global warming; however, there are studies showing that the inherent reduction in GHG emissions (from less fossil fuel use) from a switch to a green hydrogen economy would have a net positive impact on the climate, even if hydrogen losses into the air during the production/combustion processes reached as high as 10% of the volume burned.

Using hydrogen in an internal combustion engine, does not emit sulphur dioxide, carbon monoxide, heavy metals, hydrocarbons, polycyclic aromatic hydrocarbons (PAHs) and limited particulate matter (PM). PM will however still be produced from the cylinder lube oil. However, the combustion of hydrogen can lead to the thermal formation of nitrogen oxides (NOx). This can be controlled if the combustion conditions are optimised. In addition, using selective catalytic reduction (SCR) or exhaust

gas recirculation EGR will reduce NO<sub>x</sub> emissions, although some emissions are also expected from the use of pilot fuel.

When a hydrogen fuel cell system is used, the emissions of NO<sub>x</sub>, sulphur oxides (SO<sub>x</sub>), or PM can be fully eliminated, since the fuel cells have no incomplete combustion products, and no pilot fuel is needed. If a carbon fuel is reformed inside the fuel cell into hydrogen, a low amount of NO<sub>x</sub> emissions may be formed in the subsequent heat and energy recovery systems. Hydrogen leakage or unreacted hydrogen from fuel cells during operation can also add to GHG emissions.

### **Availability**

To ensure the large-scale production of green hydrogen for the maritime industry, the production capacity of renewable electricity needs to be enhanced. While there is a limit at which economies can increase the renewable electricity based on available solar and wind farms, worldwide production of renewable electricity would be adequate to produce enough green hydrogen for the global fleet by 2040, not considering the demand from other sectors. The shortage is expected to be in the electrolyzers. At the same time, competition from the industrial sectors for renewable electricity and green hydrogen can also be expected to worsen shortages for shipping if pending supply issues are not addressed. It should be noted that the regulatory environment and government policies will play a crucial role in encouraging or discouraging investments in renewable energy. Favourable policies such as tax incentives, subsidies, and feed-in tariffs can significantly increase the return on investment and reduce the overall risks. Capital cost is a major consideration for investors in renewable energy, since installation costs can include a significant upfront expense. After the plant has been installed, the operational cost is marginal, so the capital investment cost corresponds to the cost of the hydrogen being produced in the lifetime of the plant. Therefore, the availability of financing options, like cost of capital, and the overall financial market conditions may affect both the viability of the project and the willingness to invest in facilities.

### **Suitability**

Hydrogen is currently not used by ocean-going ships and is used by only very few coastal ships for propulsion purposes. However, it is considered as a fuel of the future for short-sea shipping. Reviews of storage and distribution on land, combustion in internal combustion engine or use of fuel cells have not revealed insurmountable barriers to its use as a fuel. However, storing hydrogen seems to be an obstacle, with compressed gas storage suffering from low storage densities even at high pressures and liquid hydrogen needing to be stored in specialised, highly insulated or vacuum-insulated tanks.

While transporting hydrogen over longer routes, liquid organic hydrogen carriers (LOHC) and ammonia as hydrogen carriers appear to be less costly solutions. In merchant ships the technical details relating to loading and offloading of hydrogen into a LOHC for onboard could be a potential solution to reduce cost and optimise the storage system, but onboard installation for marine use still needs to be developed. Onboard tanks have been applied in LOHC carriers; however, the design needs to be revisited and the design needs specifically to be made for merchant ships. This investigation could begin after large-bore engines become available for hydrogen operations.

Cost and storage issues notwithstanding, it is acknowledged that, when combusted, hydrogen offers low emissions and high combustion efficiencies. The development of precombustion carbon-capture solutions such as Thermo-Catalytic Decomposition (TCD) rely on having hydrogen engines and fuel cells available, and the advantage is that they do not require hydrogen storage since hydrogen-carriers other than hydrogen are stored onboard ships. Even though the technology readiness level (TRL) of this technology is rather low, the initial test results are promising. Since this technology produces solid carbon from the decomposer instead of liquid CO<sub>2</sub> and given the huge demand for graphite and other materials produced from solid carbon in today's market, this can be turned into potential income. So, this type of technology may pave the way for the development of 2-stroke, large-bore hydrogen engines.

## Techno-Economic Aspects

The storage capacity of hydrogen, in either liquid or compressed states, will be a challenge for certain ship types. Vessels plying short-sea routes – primarily coastal vessels – have the potential to adopt hydrogen- as a fuel because their frequency of port calls and bunkering would support lower bunker capacities once hydrogen-bunkering infrastructure becomes available.

In long-range shipping, the total cost of ownership (TCO) for hydrogen-fuelled vessels in principle remains as a barrier, though this may evolve in time. The example cases of ferry Ro-Pax and Ro-Ro vessels presents a TCO for green hydrogen that is about 3 times higher than vessels powered by conventional (fossil) fuels in 2030, and about 20-30% higher TCO in 2050.

For vessels powered with blue hydrogen (i.e., during the process of converting the natural gas into hydrogen, CO<sub>2</sub> emissions are captured and stored), the TCO in 2030 is about 2 times higher and the TCO may even reach cost parity in 2050. Regarding green hydrogen, however, this is only feasible if the price for marine fossil fuels is high and/or carbon costs are high (e.g. European Trading Scheme). In case no carbon costs apply, the TCO for the green hydrogen-powered vessels analysed might, in a scenario with relatively high hydrogen prices, remain up to four times higher than the TCO of the conventional vessels.

## Regulations

While there is experience from other industries with the use, generation and handling of hydrogen, there are very limited regulations for its use as a marine fuel. While this may be seen as a barrier to its adoption, there are also established methods for approving ship designs using the risk-based 'alternative design' approval process.

Also, in order to facilitate the adoption of hydrogen, classification societies have introduced rules and guidelines. Concurrently, GHG regulations are being put in place in the EU via the 'Fit-for-55' package of measures and these should provide a regional framework to incentivise the transition to low- and zero-carbon fuels. At the IMO, in MEPC 80, Marine Fuel Life Cycle GHG Guidelines have been adopted, while it has been acknowledged that there is still work to be done. Mid-term measures are expected to be decided in the following years, including technical and economic element are expected to provide additional stimulus for alternative fuels, such as hydrogen.

## Risk and Safety

This study assesses several possible designs for hydrogen-fuelled ships from the risk and safety perspective. In particular, three ship types have been analysed:

- H<sub>2</sub>-Fuelled Ro-Pax Vessel (with a compressed H<sub>2</sub> tank and fuel supply system)
- H<sub>2</sub>-Fuelled Product Carrier (with a compressed H<sub>2</sub> system)
- CH<sub>4</sub>-to-H<sub>2</sub> conversion and H<sub>2</sub> use onboard Product Carrier, Ferry, and Very Large Crude Carrier (VLCC)

Regarding risk and safety, the analysis demonstrated that there are some major concerns to hydrogen as marine fuel related to hydrogen flammability range, leakage, flame speed, and detonation/deflagration issues. These issues require further detailed studies to better understand the risks and additional safeguards that will need to be implemented to prevent or mitigate the major hazards.

The HAZID studies identified preventive and mitigative safeguards and recommendations for various ship types. While some safeguards stemmed from the IGF Code for methane as marine fuel, a large number of safeguards identified in the studies are considered additional safeguards due to the inherent risks of hydrogen.

It is important to note that not all safeguards and recommendations listed in HAZID registers will be applicable to all ship types and need to be carefully considered. However, they are all listed for consideration and may help to inform prescriptive requirements and develop inherently safer designs and arrangements. Importantly, the additional safeguards and recommendations will contribute to further risk reduction.

To conclude, for the shipping industry, hydrogen is a new fuel to shipping and not commonly transported as cargo. However, it has been produced and used in other industries, such as the petrochemical and automotive industry. Therefore, as a first step, it would be valuable to evaluate and possibly adopt the existing practices for marine application.

# Table of Contents

<b>Executive Summary</b> .....	<b>2</b>
<b>1. Introduction</b> .....	<b>13</b>
1.1 Background .....	13
1.2 Scope and Objectives .....	13
1.3 Acronym List.....	14
<b>2. Using Hydrogen in the shipping sector</b> .....	<b>15</b>
2.1 Hydrogen Properties and Production Technologies .....	15
2.1.1 Properties of Hydrogen .....	15
2.1.2 Production Pathways .....	16
2.1.3 Level of Maturity of Technologies .....	21
2.1.4 Developments in the Production Capacity of Green Hydrogen .....	22
2.1.5 Production Conclusions .....	27
2.2 Sustainability .....	28
2.2.1 GHG Performance .....	28
2.2.2 Air Pollution .....	31
2.2.3 Other Environmental Impacts.....	32
2.2.4 Sustainability Conclusions .....	34
2.3 Availability.....	36
2.3.1 European Availability.....	37
2.3.2 Worldwide Availability .....	37
2.3.3 Link with Other Sectors .....	39
2.3.4 Availability Conclusions.....	40
2.4 Suitability .....	40
2.4.1 Storage, Distribution and Production .....	40
2.4.2 Material-Based Storage Options .....	43
2.4.3 Onboard Fuel Supply .....	44
2.4.4 Internal Combustion Engines .....	46
2.4.5 Thermo-Catalytic Decomposition (TCD) process .....	51
2.4.6 Fuel Cells .....	52
2.4.7 Suitability Conclusions .....	53
2.5 Cost Developments and Techno-Economic Analysis .....	54
2.5.1 General Considerations .....	54
2.5.2 CAPEX .....	56
2.5.3 OPEX .....	60
2.5.4 TCO Retrofit .....	63
2.5.5 TCO New Building Estimation.....	65
2.5.6 Techno-Economic Conclusions.....	69
<b>3. Safety and Environmental Regulations, Standards and Guidelines</b> .....	<b>71</b>
3.1 Introduction: Bunkering, On-board Storage, Handling and Use of Hydrogen .....	71
3.2 International.....	71
3.2.1 International Organization for Standardization (ISO).....	71
3.2.2 International Maritime Organization (IMO) Requirements .....	75
3.2.2.1 SOLAS .....	75
3.2.2.2 MARPOL .....	83
3.2.3 International Bunker Industry Association.....	88
3.2.4 The Society of International Tanker and Terminal Owners (SIGTTO) .....	88
3.2.5 Society for Gas as a Marine Fuel (SGMF).....	90
3.2.6 International Electrotechnical Commission .....	91
3.2.7 Society of Automotive Engineers International (SAE) .....	91
3.2.8 International Council on Combustion Engines (CIMAC).....	92

3.2.9	International Association of Classification Societies (IACS) .....	92
3.3	Regulations for EU Member States .....	97
3.4	Other National Regulations .....	100
3.4.1	United States .....	100
3.4.2	Australia .....	101
3.4.3	United Kingdom .....	102
3.4.4	Japan .....	102
3.4.5	China .....	103
3.5	Gap Analysis .....	104
3.6	Marine Regulation Conclusions .....	115
<b>4.</b>	<b>Risk Assessment Using Hydrogen as Marine Fuel in Merchant ships .....</b>	<b>117</b>
4.1	Hydrogen Safety .....	117
4.1.1	Physical and Thermodynamic Properties of H <sub>2</sub> .....	118
4.1.2	Safety Considerations for the Use of Gaseous and Liquid Hydrogen .....	121
4.1.3	Combustion Property .....	122
4.1.3.1	Ignition .....	122
4.1.3.2	Ignition Energy .....	122
4.1.3.3	Flammability Limit .....	123
4.1.3.4	Flame Propagation .....	123
4.1.4	Dispersion .....	123
4.1.5	Viscosity .....	123
4.1.6	Gaseous Heat Capacity, Thermal Conductivity and the Joule-Thomson Coefficient .....	123
4.1.7	Hydrogen Embrittlement and Attack .....	124
4.2	HAZID Objectives, Process, Scope and Assumption .....	124
4.2.1	Objectives .....	124
4.2.2	Common Scope .....	124
4.2.3	HAZID Workshop Methodology .....	125
4.2.4	Limitations .....	126
4.2.5	Risk Ranking .....	127
4.2.5.1	Grouping Systems/Areas for HAZID .....	127
4.2.5.2	Modes of Operation .....	128
4.2.6	Hazards .....	128
4.2.6.1	General Compressed H <sub>2</sub> Related Hazards .....	128
4.2.6.2	System Hazards .....	128
4.2.6.3	External Hazards .....	129
4.2.6.4	Ship-Applicable Hazards .....	129
4.2.6.5	Common Failure Causes .....	129
4.2.7	General Assumptions – Applicable to all HAZID Studies .....	130
4.3	HAZID Results – Findings and Recommendations .....	130
4.3.1	Summary of Important Recommendations: .....	130
4.4	Hydrogen-Fuelled Ro-Ro Passenger Ship .....	132
4.4.1	Principal Particulars .....	132
4.4.2	Assumptions – Ro-Ro Passenger Ship .....	134
4.4.3	Results and Recommendations .....	134
4.5	Hydrogen-Fuelled Product Carrier .....	136
4.5.1	Assumptions – Product Carrier .....	137
4.5.2	Results and Recommendations .....	137
4.6	Hydrogen-Fuelled Ship Using CH <sub>4</sub> to H <sub>2</sub> Conversion Technology .....	139
4.6.1	Process Description .....	140
4.6.2	Assumptions .....	143
4.6.3	Results and Recommendations .....	144



4.7	Hydrogen HAZIDs Conclusions.....	146
<b>5.</b>	<b>Overall Conclusions of Hydrogen Study .....</b>	<b>152</b>
	<b>References.....</b>	<b>158</b>
	<b>Appendix I – Symbols, Abbreviations and Acronyms .....</b>	<b>168</b>
	<b>Appendix II – Impact of H<sub>2</sub> Auxiliary Engines and Fuel Cells in CII.....</b>	<b>172</b>
	<b>Appendix III – Hydrogen Safety Data Sheet (SDS) .....</b>	<b>181</b>
	<b>Appendix IV – Pilots and other Projects with Hydrogen-Fuelled Ships.....</b>	<b>182</b>
	<b>Appendix V – Additional Details of the TCO Modelling for Hydrogen-Fuelled ships .....</b>	<b>184</b>
	<b>Appendix VI – H<sub>2</sub> Classification per GHS and ECHA .....</b>	<b>188</b>
	<b>Appendix VII – HAZID Risk Matrix.....</b>	<b>189</b>
	<b>Appendix VIII – List of Recommendations Ro-Pax .....</b>	<b>191</b>
	<b>Appendix IX – HAZID Register Ro-Pax .....</b>	<b>200</b>
	<b>Appendix X – List of Recommendations Product Carrier .....</b>	<b>381</b>
	<b>Appendix XI – HAZID Register Product Carrier .....</b>	<b>387</b>
	<b>Appendix XII – List of Recommendations CH<sub>4</sub> to H<sub>2</sub> Technology .....</b>	<b>455</b>
	<b>Appendix XIII – HAZID Register CH<sub>4</sub> to H<sub>2</sub> Technology .....</b>	<b>477</b>
	<b>Appendix XIV – Detailed Regulatory Gap Analysis.....</b>	<b>552</b>

## List of Tables

Table 1. Key properties of hydrogen in comparison to MGO .....	15
Table 2. Summary comparing different types of electrolyzers .....	19
Table 3. TRL of green hydrogen-production technologies .....	21
Table 4. Large green hydrogen projects worldwide.....	23
Table 5. Summary of green hydrogen production pathways.....	27
Table 6. Lifecycle GHG emission factors for green hydrogen vs. fossil marine fuels .....	29
Table 7. GHG impact of hydrogen emissions.....	31
Table 8. Lifecycle GHG emissions and air-pollutant emissions from green hydrogen vs fossil marine fuels .....	35
Table 9. Projections of global renewable electricity production from various scenarios (TWh/year) (CE Delft & RH DHV, 2020) .....	38
Table 10. Availability of green hydrogen, renewable electricity and electrolyser capacity for global maritime shipping in 2040 .....	39
Table 11. Materials Compatible with Hydrogen.....	42
Table 12. Key properties, required storage capacity and supply conditions of alternative fuels.....	45
Table 13. Comparison between Low-Pressure and High-Pressure DF engines.....	47
Table 14. Marine engines in service and under development, as per the different alternative fuels .....	49
Table 15. Types of Fuel Cells and their Applications .....	52
Table 16. Uncontained and contained volumetric energy density for HFO, liquid hydrogen and compressed gaseous H <sub>2</sub> .....	55
Table 17. Storage tank and FSS cost.....	60
Table 18. Comparison of annual CAPEX for retrofitting and newly built hydrogen combustion systems .....	65
Table 19. Main characteristics and attributes of IMO fuel containment systems .....	77
Table 20. Requirements for fuel tank material specifications.....	78
Table 21. Excerpts from IGF Code, Adoption of the International Code of Safety for Ships using Gases or Other Low-Flashpoint Fuels (MSC.391(95)).....	80
Table 22. Tank-to-Wake Carbon Factors for different types of fuels (MEPC.364(79)) .....	87
Table 23. IACS URs .....	93
Table 24. IACS Recommendations .....	95
Table 25. Gap Analysis Legend.....	104
Table 26. Synopsis on Regulatory Gap Analysis for Hydrogen .....	105
Table 27. Selected safety related physical and thermophysical properties of H <sub>2</sub> .....	118
Table 28. Safety related combustion property of Hydrogen .....	119
Table 29. Comparison with Other Common Gas.....	119
Table 30. Property comparison Hydrogen and Methane.....	120
Table 31. Potential Ignition Sources .....	122
Table 32. Ro-Ro Vessel HAZID Risk Ranking Summary .....	135
Table 33. Product Carrier HAZID Risk Ranking Summary.....	138
Table 34. CH <sub>4</sub> to H <sub>2</sub> - HAZID Risk Ranking Summary.....	145
Table 35. Summary of hazards and causes from HAZID studies .....	150
Table 36. Summary of the Observations .....	154
Table 37. Running Hours per annum .....	172

Table 38. Main Engine Operational Data .....	172
Table 39. Auxiliary Engine Data** .....	172
Table 40. Consumption per year .....	173
Table 41. Distance Travelled nm .....	173
Table 42. Carbon Factors .....	173
Table 43. AER uncorrected values .....	173
Table 44. Estimated CII Rating .....	173
Table 45. Correction based on MEPC.335(78) .....	174
Table 46. AER Corrected values .....	174
Table 47. Estimated CII Rating .....	174
Table 48. Consumption .....	174
Table 49. AER Corrected values .....	174
Table 50. Estimated CII Rating .....	174
Table 51. Auxiliary Engine's Operational Data with 1 H2 A/E** .....	175
Table 52. Consumption per year .....	175
Table 53. AER Uncorrected data .....	175
Table 54. Estimated CII Rating .....	175
Table 55. AER Corrected data .....	176
Table 56. Estimated CII Rating .....	176
Table 57. AER Corrected data .....	176
Table 58. Estimated CII Rating .....	176
Table 59. Operational data .....	176
Table 60. Main Machinery Operational Data .....	177
Table 61. Reliquefaction System consumption .....	177
Table 62. Boil Off Gas Amount .....	177
Table 63. Annual totals (tonnes) .....	178
Table 64. Carbon factors .....	178
Table 65. Operational data .....	178
Table 66. AER .....	178
Table 67. Estimated CII Rating .....	179
Table 68. CCS data .....	179
Table 69. Fuel Cell and CCS sizing .....	179
Table 70. Annual Totals .....	179
Table 71. AER .....	180
Table 72. Estimated CII Rating .....	180
Table 73. Pilots and other projects .....	182
Table 74. Engine cost input .....	184
Table 75. Fuel cell system cost development assumptions .....	184
Table 76. Propulsion system cost .....	185
Table 77. Battery pack cost development assumptions .....	185

Table 78. Fuel cost ranges for reference fuel and hydrogen variants in the years 2022, 2030 and 2050 per tonne of fuel .....	185
Table 79. Carbon cost per tCO <sub>2</sub> and tonne VLSFO .....	186

## List of Figures

Figure 1. Production pathways for green hydrogen.....	17
Figure 2. Electrolyser technologies currently available or under development (ABS, SETTING THE COURSE TO LOW CARBON SHIPPING).....	18
Figure 3. Hydrogen emissions along the hydrogen supply chain, based on estimations from Frazer-Nash Consultancy (2022). This supply chain examines the import of hydrogen by ship in the form of liquid hydrogen (LH <sub>2</sub> ).....	30
Figure 4. The relationship between the electrolyser's load factor and excess renewable electricity, given the sizes of the system and wind/solar park (IEA, 2017) .....	36
Figure 5. Illustration of hydrogen embrittlement (ABS, Sustainability Whitepaper, Hydrogen as Marine Fuel, 2021) .....	41
Figure 6. Example showing the process flow of the LOHC value chain by Hydrogenious LOHC Technologies. A plus refers to bonded hydrogen, a minus refers to hydrogen that is not bonded in the LOHC molecules.....	44
Figure 7. Schematic onboard hydrogen installation of the FSS for a 2-stroke Diesel-cycle hydrogen engine .....	46
Figure 8. Schematic integration of the FSS for a 4-stroke Otto-cycle hydrogen engine .....	46
Figure 9. Main engine design for the ABC BeHydro <sup>®</sup> engine, the dual-fuel hydrogen 4-stroke engine; it is available with up to 16 cylinders and delivers 2.6MW. ....	49
Figure 10. The flammability ranges for different fuels in % volume with air (ABS, Sustainability Whitepaper, Hydrogen as Marine Fuel, 2021) .....	51
Figure 11. A typical Proton Exchange Membrane (PEM) Fuel Cell (ABS, Sustainability Whitepaper, Hydrogen as Marine Fuel, 2021).....	53
Figure 12. Energy Density of Sustainable Alternative Energy Carriers and Price per Energy Unit .....	56
Figure 13. Cost range of fuel oil and hydrogen ICE systems per kW.....	57
Figure 14. Fuel cell stack cost developments and electric motor costs, the latter depending on engine power.....	58
Figure 15. Battery system cost development .....	59
Figure 16. Carbon cost per tonne of VLSFO .....	61
Figure 17. Development of fuel costs including carbon costs .....	62
Figure 18. Total cost of retrofitting (million EUR) conventional fuel to hydrogen ICE system.....	64
Figure 19. Additional yearly TCO for hydrogen-powered Ferry Ro-Pax vessels (2,000-4,999 GT).....	66
Figure 20. Additional yearly TCO for hydrogen powered Ro-Ro cargo vessel (5,000-9,999 DWT) .....	67
Figure 21. Additional annual costs/benefits if a NG to H <sub>2</sub> decomposer system is installed and used on an LNG carrier .....	69
Figure 22. Typical operating range for Liquefied Gas Carriers .....	78
Figure 23. MARPOL 73/78 Annex VI Reg 13 – NO <sub>x</sub> emission limits with respect to engine speed .....	84
Figure 24. MARPOL 73/78 Annex VI Reg 14 – SO <sub>x</sub> emission limits .....	85
Figure 25. The European Commission 'Fit-for-55' package.....	97
Figure 26. EU policies related to maritime transport .....	97
Figure 27. HAZID Process.....	125
Figure 28: RO-RO Vessel General Arrangement.....	133
Figure 29: Hydrogen Bunkering.....	134

Figure 30. General Arrangement of Product Carrier .....	137
Figure 31. System Isometric Diagram .....	140
Figure 32. System General Arrangement.....	140
Figure 33. Simplified Process Diagram .....	141
Figure 34. Chemical Carrier Application.....	142
Figure 35. Passenger Ferry Application (New construction).....	143
Figure 36. VLCC Application .....	143
Figure 37. Overview of the production cost of liquefied hydrogen in several production countries .....	186
Figure 38. TCO estimation of Ferry Ro-Pax (2000-4999 dwt) in the high fuel price scenario.....	187
Figure 39. TCO estimation of Ro-Ro vessel (5000-9999 dwt) in the high fuel price scenario .....	187

# Introduction

## 1.1 Background

The marine industry is facing significant challenges. Stringent environmental regulations, uncertainties about the impact of globalisation, geopolitical influences, digitalisation and cyber risks are multiplying an already complex operating landscape. At the same time, shipping stakeholders are trying to identify and deploy the most suitable decarbonisation strategies by investigating propulsion efficiencies and fuel options.

However, the most important threat to the planet is the increase of global temperatures, caused mainly by anthropogenic emissions. The shipping industry is responsible for approximately 3% of the world's carbon-dioxide (CO<sub>2</sub>) emissions caused by human activities; prompt actions are required for a more sustainable future.

In April 2018, the IMO agreed to align its regulation with the goals of the UN's Paris Agreement and reduce GHG emissions from shipping. The IMO Initial GHG-reduction strategy (Resolution MEPC.304(72)), included ambition to reduce annual emissions by at least 50% by or around 2050 (compared to 2008), signalling to the shipping industry the beginning of a massive and international shift towards the uptake of zero-carbon and low-carbon fuels. This strategy has been revised in 2023 during MEPC 80, increasing significantly the levels of ambition, towards reaching net-zero GHG emissions by or around 2050.

With the average commercial ship having a lifetime of more than 20 years, owner uncertainty about what investments to make, have put a hold on many decisions for new buildings. Pressure is building for the transition to begin as soon as possible and regulatory developments in the European Union indicate that a quicker response may be needed from the industry.

Hydrogen fuel is a new renewable feedstock for production of other types of fuels and chemicals, and it can be used directly as a fuel or clean-energy source. Currently, designers, builders, owners and operators are looking into hydrogen (H<sub>2</sub>) as an environmentally friendly alternative source of energy to the use of conventional fossil fuels.

This study provides information on the properties, production, suitability and sustainability of using hydrogen as a marine fuel to all stakeholders and regulators. Moreover, it offers an extensive analysis of the current regulatory frameworks, techno-economic assessments and a series of detailed risk-based case studies highlighting the commercial and safety implications of using hydrogen as a marine fuel.

## 1.2 Scope and Objectives

The scope and objectives of this study examine the technical issues, regulatory frameworks and state of play for application of hydrogen as a fuel. They address the potential for Hydrogen to be used as fuel in shipping, which was part of EMSA tender EMSA/OP/43/2020 for 'Studies on Alternative Fuels/Power for shipping' and which was detailed in the ABS, CE Delft and Arcsilea proposal of 27 January 2021.

The scope specifically addresses the tasks of the EMSA tender by:

- Providing a state of play on the use of alternative fuel/power in the shipping sector. (See Section 2 of this report for the findings under this task.)
- Providing a detailed description of the existing safety and environmental standards/regulations/guidelines on the production, transport, and distribution, bunkering and onboard storage, handling and use of alternative fuels/power for shipping, as well as those currently under development. (See Section 3 of this report for the findings under this task.)
- Providing a safety assessment of the fuelled/powered cargo and passenger ships, engaged in the short-sea (coastal) or deep-sea trades. In total, four safety assessments are offered. If a ship can accommodate cargo and passengers (for example, a Ro-Pax ship), only one safety assessment is needed (for short-sea), without prejudice of conducting two remaining assessments for a cargo ship. Consideration should be given whenever simultaneous transport and usage of the fuel (or energy carrier). (See Section 4 of this report for the findings under this task.)

### 1.3 Acronym List

Refer to Appendix I – Symbols, Abbreviations and Acronyms.

## 2. Using Hydrogen in the shipping sector

This section provides an overview of the state of play for using hydrogen as a fuel in the shipping sector. It is divided into the following sections:

- An overview of hydrogen's properties with descriptions of the production pathways, level of maturity and further developments.
- Sustainability details, including an overview of GHG performance, air pollution and other effects.
- Availability details, including an overview of current and future supply in the EU and worldwide, and in connection to other sectors.
- Suitability details, including storage and production, onboard fuel supply, internal combustion engines, machinery spaces and fuel cells.
- Cost and development of hydrogen systems for marine applications, including a techno-economic analysis on the Total Cost of Ownership (TCO) for several vessel categories.

### 2.1 Hydrogen Properties and Production Technologies

Hydrogen is a widely used, commercially available chemical. It is a building block for many chemical and pharmaceutical products, notably for the ammonia used as a fertiliser in food crops.

The global production of hydrogen in 2021 was approximately 94 million tonnes (Mt), of which only 0.04% (35,000t) was 'green' hydrogen produced from electrolysis (IEA, 2022). Broadly, the hydrogen was used in refineries, for fertiliser production, and in other industrial areas. For comparison, the annual consumption of conventional residual and distillate fuels by international shipping is about 285 Mt per year, or equivalent to about 95 Mt/year of hydrogen, based on its lower heating value (see Table 1).

This section of the study examines the properties of hydrogen (subsection 2.1.1), its production pathways (subsection 2.1.2), the maturity levels of the production technologies (subsection 2.1.3) and ongoing pilot projects (subsection 2.1.4). The conclusions of this section are presented in subsection 2.1.5.

#### 2.1.1 Properties of Hydrogen

At atmospheric temperature and pressure, hydrogen is a colourless gas without a smell. Its main properties are displayed in Table 1.

Table 1. Key properties of hydrogen in comparison to MGO

Item	Hydrogen	MGO
Energy density (MJ/L)*	8.51	35.95
Lower heating value (MJ/kg)	120	42.8
Heat of vapourisation (kJ/kg)	449	250-450
Auto-ignition temperature (°C)	585	250
Liquid density (kg/m <sup>3</sup> )	70.8 (at -253 °C)	840 (at 15 °C)
Adiabatic flame temperature at 1 bar (°C)	2127	2000
Molecular weight (g/mol)	1.007825	54
Melting point (°C)	-259	-26
Boiling point (°C)	-253	154
Flash point (°C)	N/A	60
Critical temperature (°C)	-239.8	654.9
Critical pressure (bar)	1.30	30
Flammable range in dry air (%)	4 to 75	0.7 - 5



Item	Hydrogen	MGO
Minimum ignition energy (mJ)	0.017	0.23
Cetane number	N/A	40
Octane number	>130	15-25

\* Liquid hydrogen is considered

## 2.1.2 Production Pathways

Currently, hydrogen is mostly produced by steam methane reforming (SMR) or autothermal reforming (ATR) of natural gas (Yusef Bicer, 2017). In 2021, 62% of the hydrogen was produced from natural gas, 19% from coal, 0.7% from oil, 0.04% from electricity (water electrolysis) and 18% as a by-product of naphtha reforming at refineries (IEA, 2022).

Hydrogen made from fossil sources is called 'grey' hydrogen. When the CO<sub>2</sub> emissions from the process of converting natural gas are captured and stored, it is typically referred to as 'blue' hydrogen. Only 0.7% of global hydrogen production in 2021 was blue hydrogen (IEA, 2022).

Blue hydrogen production still results in greenhouse gas (GHG) emissions. Methane (which is a much more potent GHG than CO<sub>2</sub> – 82.5 times that of CO<sub>2</sub> on a 20-year global warming potential (GWP) basis and 29.8 times on a 100-year basis, according to the Intergovernmental Panel on Climate Change's AR6 report)- has the potential to leak at the production plant level or at any point along the natural gas-distribution chain. Also, the efficiency of CO<sub>2</sub> capture from the reforming processes (SMR and ATR) is lower than 95%. Moreover, the production of blue hydrogen is dependent on fossil fuels.

Considering the above, green hydrogen, which is made from renewable-energy sources<sup>1</sup>, is generally considered to be the end-solution for decarbonising the production and use of hydrogen. Conversely, blue hydrogen is considered to be a transitional solution. Therefore, this study focuses on green hydrogen.

Four production pathways for green hydrogen have been identified (see Figure 1), which are separately described below.

<sup>1</sup> The Renewable Energy Directive of the European Union (RED II) defines 'renewable energy' as "energy from renewable non-fossil sources, namely wind, solar (solar thermal and solar photovoltaic) and geothermal energy, ambient energy, tide, wave and other ocean energy, hydropower, biomass, landfill gas, sewage treatment plant gas, and biogas" (EU, 2018).

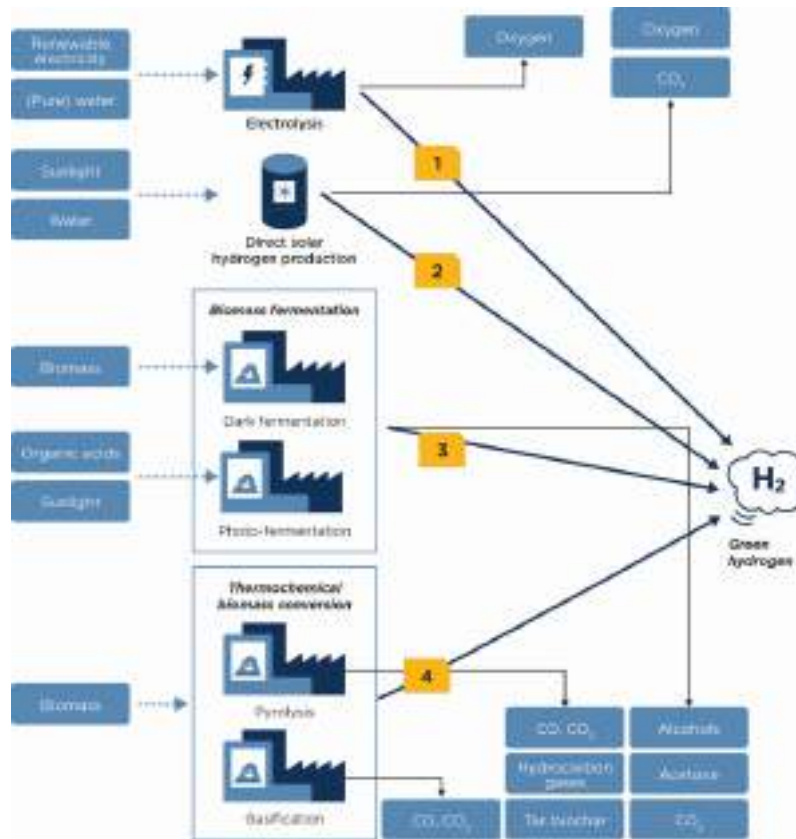

Figure 1. Production pathways for green hydrogen.

### **Electrolysis (pathway 1)**

In the first pathway, green hydrogen is produced through water electrolysis using renewable electricity. This form can be also called ‘e-hydrogen’ and, in the context of the EU’s Renewable Energy Directive (RED), it is considered a renewable fuel of non-biological origin (RFNBO). It has the potential to become the main pathway for scaling up the production of green hydrogen, with new and bigger electrolyser projects being announced continuously (subsection 2.1.4). The use of electrolysis for green hydrogen production is not new. Until the 1960s, most fertilisers sold in Europe were based on hydrogen produced with hydropower-based electrolysis for ammonia production in Norway.

Currently, there are two main electrolyser technologies to consider: alkaline and proton exchange membrane (PEM). The alkaline technology is currently the most advanced and cheapest option and has a relatively high electricity-to-hydrogen efficiency of 63-70% (IEA, 2019). The PEM electrolyser is less developed, more expensive and has a lower efficiency (56-60% (IEA, 2019)). However, this type of electrolyser is expected to be more operationally flexible (i.e., its load factor can be better adjusted to fluctuating power output from wind and solar parks) than the alkaline version.

The solid-oxide electrolyser cell (SOEC) is another technology, which is not commercially available at this point of time and far from being implemented on a large scale. This technology works at a high temperature and has the potential to offer a greater energy efficiency than alkaline and PEM (74-81%, according to the IEA (2019)), especially when integrated with concentrated solar plants, which enable heat utilisation (IEA, 2017). These three electrolyser technologies are illustrated in Figure 2 and summarised and compared in Table 2.

PEM electrolyzers use a proton-exchange membrane and a solid polymer electrolyte (hence, they are also referred to as polymer electrolyte membrane electrolyzers). When electric current is applied, the water splits into hydrogen and oxygen and the hydrogen protons pass through the membrane to form gas on the cathode side. Increasing the density of the current enables a more rapid system response to fluctuations in energy input, which can be a great benefit when working with renewable-energy sources that are intermittent.

PEM electrolyzers operate at temperatures between 50-80°C, but at higher pressures than alkaline electrolyzers. Typical PEM electrolyzers are constructed using more rare earth metals than alkaline electrolyzers and require more

precise construction techniques for their catalysts, which makes them more expensive to produce and maintain. In 2021, about 25% of the installed electrolyser capacity worldwide was based on PEM technology (IEA, 2022).

Alkaline electrolysers use a liquid-electrolyte solution, such as potassium hydroxide or sodium hydroxide and water. When current is applied, the hydroxide ions move through the electrolyte from the cathode to the anode of each cell, generating hydrogen-gas bubbles on the cathode side of the electrolyser and oxygen gas at the anode, as represented in Figure 2.

Alkaline electrolysers can be unipolar or bipolar in design. Unipolar designs, also known as monopolar or tank designs, have their electrodes suspended, in parallel, in alternating tanks separated by thin membranes that allow the ions to be transferred, but restrict the movement of the gases that are produced. Bipolar designs position the electrodes very close to each other, separated by a thin non-conductive membrane. Unipolar designs have the advantage of being cheaper and easier to build and maintain. Nevertheless, they are typically less efficient than bipolar designs.

Alkaline electrolysers operate best near their design loads; they experience a drop in efficiency when operating under lower loads. Both designs for alkaline electrolysers are more durable and contain fewer expensive rare-earth metals than PEM and solid oxide electrolysers. In 2021, almost 70% of the installed electrolyser capacity was based on alkaline technology (IEA, 2022).

Solid-oxide electrolysers use solid ceramic material for the electrolyte. Electrons from the external circuit combine with water at the cathode to form hydrogen gas and to negatively charge ions. Oxygen then passes through the solid ceramic membrane and reacts at the anode to form oxygen gas and generate electrons for the external circuit. Solid-oxide electrolysers, being in an early stage of development and requiring temperatures of more than 700°C to operate, are less likely to be used anytime soon.

All electrolyser technologies require pure, deionised water to be split into hydrogen and oxygen. To produce this kind of water, freshwater can be purified, using filtration, deionisation or reverse-osmosis processes. If access to freshwater is a challenge, seawater can be desalinated and then purified. Water-purification technologies such as mechanical vapour compression and reverse osmosis are available commercially. Water desalination and purification typically represent less than 1-2% of the total cost of hydrogen production. It is important to purify the water to demineralized water quality before it is used by the electrolysers, as their lifetime and performance are severely affected by the water impurities. For example, a PEM electrolyser (possibly the most stringent when it comes to water purity) requires water with a resistivity of minimum 1MΩ-cm.

During the electrolysis process, impurities that need to be removed may appear. Typically, oxygenates (oxygen and water) need to be removed from the hydrogen, as these can have detrimental effects on the synthesis catalyst if hydrogen is used for production of other chemicals. Deoxidisers are required for this task. The purity of the hydrogen that is produced could be further increased by removing argon, which will improve downstream production efficiency. However, this is only a minor improvement. No further impurities are expected.

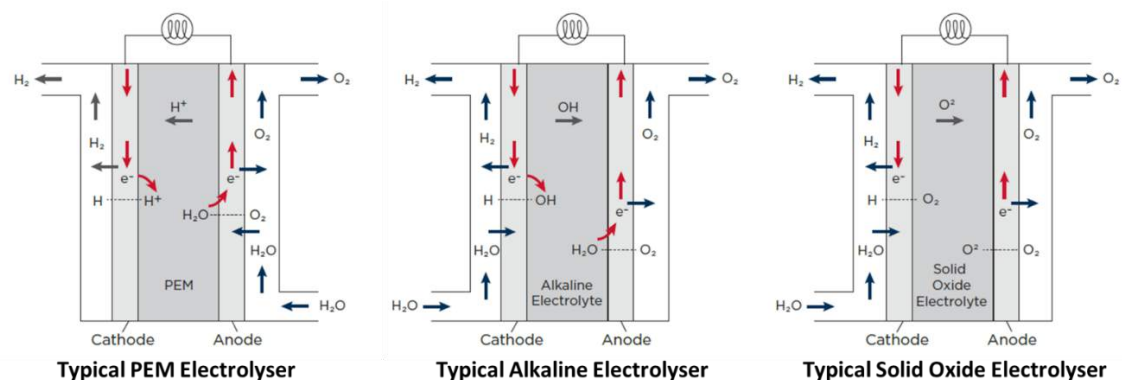

Figure 2. Electrolyser technologies currently available or under development (ABS, SETTING THE COURSE TO LOW CARBON SHIPPING)

Table 2. Summary comparing different types of electrolyzers

Name	PEM Electrolyser	Alkaline Electrolyser	Solid Oxide Electrolyser
Electrolyte	Solid Polymer	Aqueous Alkaline Solution (KOH or NaOH)	Solid Oxide, Yttria-stabilised Zirconium Oxide
Electrical efficiency (based on lower heating value)	56-60%	63-70%	74-81%
Current Density [A/m <sup>2</sup> ]	10,000-20,000	2,000-4,000	3,500-5,500
Operating Temperature [°C]	50-80	60-90	500-850
Input Component(s)	Deionised Water	Deionised Water and Alkali Material	Deionised Water (Steam)

## **Direct solar hydrogen production (pathway 2)**

An alternative way to produce renewable hydrogen is through ‘direct solar hydrogen’, in which energy from sunlight is used to split water into hydrogen and oxygen without using a solar electricity generation unit and electrolyser. There are three possible processes: photo-electrolysis, thermolysis and biophotolysis, as further described below.

### *Photo-electrolysis*

Photo-electrolysis, also called photoelectrochemical hydrogen, is a process that makes use of a photoelectrochemical cell, which drives water-splitting redox (reduction-oxidation) reactions. The electrical energy for this process could be generated using concentrated solar power (which bundles sunlight using mirrors or lenses) (IEA, 2017), photovoltaic cells (Bellini, 2021), or photoactive material (Radowitz, 2021). This technology is in the research-and-development phase and promises to have the highest hydrogen yield in geographical areas with high solar-irradiation factors and clear skies. The solar-to-hydrogen energy efficiency that has been reported varies across literature. In a techno-economic review, (Grimm, de Jong, & Kramer, 2020) settled with an efficiency of 10%.

### *Thermolysis*

In thermolysis, also called thermochemical water splitting, water is heated to a very high temperature until it decomposes into hydrogen and oxygen. In a simple process configuration, a temperature of 2,500 °C would be necessary to split the water. Several thermochemical water-splitting cycles have been proposed by researchers to reduce the required temperature and improve the efficiency of the process; these include a multi-stage Cu-Cl cycle (with temperatures up to 500°C) and a two-step SnO<sub>2</sub>/SnO cycle (with temperatures up to 1,600°C). These temperatures could be generated by solar-heat collectors. A higher solar light intensity improves the hydrogen yield and the energy efficiency of the process. The energy efficiency is estimated at 20-45% (Nikolaidis & Poullikkas, 2017).

### *Biophotolysis*

In the process of biophotolysis, bacteria or algae split water into hydrogen and oxygen using energy from sunlight, through their hydrogenase- or nitrogenase-enzyme systems. A distinction can be made between *direct* and *indirect* biophotolysis. In the process of *direct* biophotolysis, green algae split water molecules into oxygen and hydrogen ions through photosynthesis, after which the hydrogen ions are converted to hydrogen gas by hydrogenase enzyme. In *indirect* biophotolysis, cyanobacteria or blue-green algae produce a hydrocarbon from water, CO<sub>2</sub> and sunlight as an in-between step, after which the hydrocarbon reacts with water to form hydrogen and CO<sub>2</sub>.

The technological challenges that will need to be overcome are the low energy efficiency of biophotolysis (which ranges from 3-16% (Melitos, Voukopoulos, & Zabaniotou, 2021), the large surface area required to collect sufficient

sunlight, the short duration of the process and the high cost of photobioreactors. Biophotolysis has been demonstrated at laboratory scale. Nonetheless, operation over long periods and at large scale has yet to be developed. *Indirect* biophotolysis is still in a conceptual stage (Tamburic, Dechatiwongse, Zemichael, Maitland, & Hellgardt, 2013) (Nikolaidis & Poullikkas, 2017).

### **Biomass fermentation (pathway 3)**

Biomass fermentation is a biochemical process in which bacteria are used to convert biomass to alcohols, acetone, hydrogen and CO<sub>2</sub>. Again, here there are three potential processes: dark fermentation, photo-fermentation and 'multi-stage fermentation', which are detailed below.

#### *Dark fermentation*

Dark fermentation is an anaerobic process (in the absence of oxygen) in which biomass is decomposed into hydrogen, CO<sub>2</sub> and other intermediate products using bacteria. A wide range of bacterium types, which may be active at different temperature ranges could be used. Anaerobic bacteria that are active between 25-70°C can be used to convert biomass compounds such as sucrose, cellulose, glucose and starches. The technology of dark fermentation is still in an early stage of development and the main challenge is the low hydrogen concentration (40-60%) of the product gas. One area of research looks at improving the hydrogen yield by coupling the dark-fermentation process with other processes and technologies, such as photo-fermentation, methanogenesis, microbial electrolysis cells and microbial fuel cells (Ghavam, Vahdati, Wilson, & Styring, 2021). The energy efficiency of dark fermentation is estimated at 60-80% (Nikolaidis & Poullikkas, 2017).

#### *Photo-fermentation*

In photo-fermentation, photo-synthetic bacteria convert organic acids (acetic, lactic and butyric) and water into hydrogen and CO<sub>2</sub> using sunlight under deficient nitrogen conditions. A higher light intensity increases the hydrogen yield. At the same time, it reduces the light-conversion efficiency. Two problems with the use of industrial wastewater as an input is that the colour of the wastewater could reduce the penetration of light and that the presence of toxic matter may require a pre-treatment step. Key barriers to the breakthrough of photo-fermentation are the low conversion efficiency of solarenergy (about 0.1%), the need for large reactors covering large land areas and the limited availability of organic acids (Nikolaidis & Poullikkas, 2017).

#### *Multi-stage fermentation*

With 'multi-stage fermentation', a combination of different fermentation processes is applied, using both non-photosynthetic and photosynthetic bacteria. In a first stage, dark fermentation could be used to convert biomass feedstock to hydrogen and by-products, while in a second stage the by-product of organic acids could be converted to hydrogen using photo-fermentation. This sequential process increases the hydrogen output and reduces the energy demand from sunlight. Higher operating temperatures may further increase the hydrogen output (Nikolaidis & Poullikkas, 2017).

Biomass fermentation is less energy intensive, more environmentally benign and more technologically advanced than thermochemical biomass conversion (see Pathway 4). However, the hydrogen yield is generally lower (Nikolaidis & Poullikkas, 2017).

### **Thermochemical biomass conversion (Pathway 4)**

For thermochemical biomass conversion, the two main processes are pyrolysis and gasification, as explained below.

#### *Pyrolysis*

Pyrolysis is the thermal decomposition of biomass at a temperature of 380-530 °C at 1-5 bar in an environment without oxygen (except when the biomass is partially combusted to provide the process heat). Biomass is converted into a gas mixture of hydrogen, carbon monoxide (CO), CO<sub>2</sub> and hydrocarbon gases, tar (a viscous liquid of

hydrocarbons) and biochar (a carbon-rich solid residue). Methane and other hydrocarbon gas products can be converted by means of steam reforming to improve the hydrogen yield of the overall process. The hydrogen yield depends on the type of biomass feedstock type, the catalyst, temperature and residence time. An energy efficiency of 35-50% can be obtained with pyrolysis (Nikolaidis & Poullikkas, 2017).

### Gasification

With thermal biomass gasification technology, woody biomass is decomposed into syngas (a gas mixture of mainly hydrogen and CO), after which the hydrogen can be separated from the gas mixture using a method such as membrane separation. The hydrogen yield can be improved through the water-gas shift reaction, in which CO and water react to form CO<sub>2</sub> and hydrogen. The reaction takes place at temperatures between 500-1,400°C and pressures between 1-33 bar, depending on plant size and the type of reactor. There are three reactor types: fixed-bed, fluidised bed, and indirect gasifiers. The hydrogen yield, which is much higher than for pyrolysis, depends on biomass feedstock, particle size, temperature, steam-to-biomass ratio and the type of catalyst. The thermal energy-to-hydrogen efficiency can reach 52% (Nikolaidis & Poullikkas, 2017). Whereas thermal gasification has been demonstrated commercially, this is not yet done on a large scale.

With supercritical water gasification, wet biomass feedstocks such as organic waste and sewage sludge, can be 'gasified' to form hydrogen and methane. The methane that is produced can be converted into hydrogen in an additional step of steam reforming. According to (Yakaboylu, Harinck, Smit, & De Jong, 2015) the carbon-conversion efficiency can be 80-100%. The biomass-to-hydrogen energy efficiency will be lower, because not all the methane produced can be reformed to hydrogen. This efficiency is estimated at 80%. Supercritical water gasification has yet to be demonstrated in the market.

Two other thermochemical processes are combustion and liquefaction, but these have low hydrogen yields. Moreover, combustion creates air pollutants and liquefaction has difficult operating conditions (50-200 bar in the absence of air) (Nikolaidis & Poullikkas, 2017).

## 2.1.3 Level of Maturity of Technologies

### Hydrogen-production technology

Scientific literature and market information regarding the technology readiness levels (TRL) of the different technologies required to produce green hydrogen suggest that the alkaline and PEM electrolyzers are currently the most mature. Alkaline electrolyzers are fully proven in an operational environment. The PEM electrolyser is also close to this stage. On the other hand, as mentioned earlier, the SOEC electrolyser has yet to be tested in an industrial environment. Most hydrogen production technologies related to the pathways of direct solar hydrogen production, biomass fermentation and thermochemical biomass conversion have yet to leave the laboratory stage, except for thermal gasification and pyrolysis pathways. The TRLs of the different technologies are shown in Table 3.

Table 3. TRL of green hydrogen-production technologies

Production pathway	Technologies	Remarks	Technology readiness level (TRL)	Sources
1. Electrolysis	Alkaline electrolyser	Alternative technologies to split pure water into hydrogen and oxygen using electricity	9	(Rouwenhorst, Van der Ham, Mul, & Kersten, 2019), (Smith, Hill, & Torrente-Murciano, 2020)
	PEM electrolyser		8-9	(Smith, Hill, & Torrente-Murciano, 2020)
	SOEC electrolyser		3-5	(Rouwenhorst, Van der Ham, Mul, & Kersten, 2019), (Smith, Hill, &

Production pathway	Technologies	Remarks	Technology readiness level (TRL)	Sources
				Torrente-Murciano, 2020)
2. Direct solar hydrogen production	Photo-electrolysis	Direct production from water using solar energy, without using electrolysis	1-3	(Smith, Hill, & Torrente-Murciano, 2020)
	Thermolysis		3-4	(Parkinson, 2019)
	Biophotolysis		1-3	(Smith, Hill, & Torrente-Murciano, 2020)
3. Biomass fermentation	Dark fermentation	Biochemical process, using bacteria.	4	(LBST and Hinicio, 2015)
	Photo-fermentation		1-3	Concluded from Nikolaidis & Poullikkas (2017)
4. Thermochemical biomass conversion	Pyrolysis	Thermochemical decomposition of biomass.	6	Concluded from Papadokonstantakis (2019)
	Thermal gasification		5-8	(LBST and Hinicio, 2015), (Parkinson, 2019)
	Supercritical water gasification		4	

Note: TRL 1 = Basic principles observed; TRL 2 = Concept formulated; TRL 3 = Experimental proof of concept; TRL 4 = Validated in lab; TRL 5 = Validated in relevant environment; TRL 6 = Demonstrated in relevant environment; TRL 7 = System prototype demonstration in operational environment; TRL 8 = System complete and qualified; TRL 9 = System proven in operational environment.

## Vessel technology

Only recently has the maritime industry begun to test and operate hydrogen-powered engines and fuel cell systems for vessels. The first project of this kind was developed (by Sandia National Laboratories) in 2016 and involved a small passenger ferry powered by a fuel cell system and operating in the bay of San Francisco. At the time of writing, five hydrogen-powered demonstration vessels have sailed, and several shipping-related consortia have initiated projects that should lead to hydrogen-powered vessels entering service by 2023/2024. A list of these projects is presented in Appendix IV – Pilots and other Projects with Hydrogen-Fuelled Ships.

### 2.1.4 Developments in the Production Capacity of Green Hydrogen

Most of the 94 Mt of hydrogen globally produced in 2021 was 'grey hydrogen' (IEA, 2022) and used in refineries for fertiliser production. For comparison, the annual consumption of conventional residual and distillate fuels by international shipping is currently estimated at 285 Mt per year, or equivalent to about 95 Mt/year of hydrogen, based on the lower heating value figures in Table 1.

Although the existing global electrolyser capacity dedicated to producing green hydrogen currently is only about 0.3 GW, the announced plans add up to a global capacity of 260 GW (IEA, 2021). It is expected that it will continue to grow rapidly, with about 460 electrolyser projects currently under development, of which about 175 are already under construction or have passed final investment decisions. Moreover, the capacity per electrolyser unit is expected to increase rapidly over time, potentially reaching 260 MW in 2025 and around 1 GW in 2030, whereas the average unit size in 2021 was 5 MW (IEA, 2022).

A non-exhaustive overview of large green hydrogen projects is presented in Table 4 (below), illustrating the global interest in increasing the green hydrogen production capacity based on electrolysis.

Hydrogen can be used to generate green electricity, e.g., during periods when sunlight and wind are less available. Hydrogen may also be used for heating in the construction industry, in the production of green cement and green steel, and as a fuel for heavy-duty vehicles and vessels (possibly in the form of hydrogen-based fuels).

Table 4. Large green hydrogen projects worldwide

Project	Stakeholders	Country	Electrolyser capacity	Hydrogen production volume (kt/year)	Project stage	Start of operation (year)	Remarks
Pampas plant (IEA, 2022) (Politi, 2021)	Fortescue Future Industries	Argentina	15 GW	2,250	Announced	2030 (start of export in 2024)	Patagonian Rio Negro province. Use of wind energy.
Asia Renewable Energy Hub (FuelCellsWorks, 2022) (HyResource, 2022)	NW Interconnected Power Pty Ltd.	Australia	14 GW	1,600	Under development	2027-2028	
Western Green Energy Hub (FuelCellsWorks, 2022) (HyResource, 2022)	InterContinental Energy, CWP Global, Mining Green Energy Ltd.	Australia	28 GW	Over 3,000	Under development	2028	
HyEnergy Project (Province Resources Limited, 2022) (HyResource, 2022) (Statista, 2021)	Total Eren, Province Resources Ltd.	Australia	8 GW	550	Announced	Unknown	In a document from Province Resources Ltd, a completion in Q1 2023 is mentioned.
Murchison Hydrogen Renewables Project (Statista, 2021) (HyResource, 2022)	Murchison Hydrogen Renewables Pty Ltd. (Parent company: Copenhagen Infrastructure Partners)	Australia	5 GW	Unknown	Announced	Unknown	
Pacific Solar Hydrogen (Austrom Hydrogen, sd)	Austrom Hydrogen	Australia	3.6 GW	200	Announced	2025- 2030	Construction is planned for 2024 and should run at full capacity in 2030.
H2-Hub Gladstone (Queensland Government, 2022) (HyResource, 2022)	The Hydrogen Utility	Australia	3 GW	Unknown	Announced	2023	Up to 5,000 tonnes per day in ammonia will be produced from the hydrogen.
Unnamed (Geraldton) (Wong, 2022)	BP	Australia	Unknown	Unknown	Announced	Unknown	1 million tonnes/yr of green ammonia, based on 4 GW wind/solar generation capacity.



Project	Stakeholders	Country	Electrolyser capacity	Hydrogen production volume (kt/year)	Project stage	Start of operation (year)	Remarks
Base One (Collins L. , 2020)	Energix Energy, Enerwind, Black & Veatch, Ceará state government	Brazil	Not stated	600	Announced	2025	Use of 3.4 GW of combined baseload wind and solar power.
HyEx (Djunisic, 2022)	Engie Latam SA, Enaex SA	Chile	0.026 GW	Unknown	Announced	2024	Enaex proposed to build a green ammonia plant with a capacity of 18,000 t/year, using Engie's green hydrogen.
HNH (Collins L. , 2020)	AustriaEnergy, Ökowind EE, CIP	Chile	1.4 GW	150-175 (800-1,000 kton NH <sub>3</sub> )	Announced	2026	1.8 to 2 GW of onshore wind power, Haber-Bosch ammonia production.
Sinopec Xinjiang Kuqa green hydrogen pilot project (Balkan Green Energy News, 2022) (NS Energy Business, 2021)	Sinopec, China Petroleum	China	0.3 GW	20	Under development (started in Dec. 2021)	2023	
Beijing Jingneng Inner Mongolia (Collins L. , 2020) (Brown & Grünberg, 2022)	Beijing Jingneng	China	< 5 GW	400-500	Under construction	Before 2025	Use of onshore wind and solar.
Unnamed (Greater Copenhagen) (S&P Global, 2021) (World-Energy, 2020)	Orsted, A P Moller-Maersk, DSV Panalpina, DFDS, SAS and Copenhagen Airports	Denmark	1.3 GW	250	Announced (feasibility study underway)	2023	First phase 2023: 10-MW electrolyzer. By 2027: 250 MW. By 2030: 1.3 GW.
Unnamed (Collins L. , 2020) (State of Green, 2021)	CIP, Moller-Maersk, DFDS, Arla, Danish Crown, DLG	Denmark	1 GW	160 (900 kton NH <sub>3</sub> )	Under development	2025-2027	Located in Esbjerg. The intended final product is green ammonia for fertiliser production and shipping.
Unnamed (H2 Energy Europe, 2021)	H2 Energy Europe	Denmark	1 GW	90	Under development	2024 (earliest)	Located in Esbjerg. The hydrogen will be used as a truck fuel.
Fortescue project (PV Magazine, 2022) (Scully, 2022)	Fortescue Future Industries, Egyptian Government	Egypt	3.6 GW	500	Announced	Unknown	Plans to develop a 9.2 GW wind and solar facility.

Project	Stakeholders	Country	Electrolyser capacity	Hydrogen production volume (kt/year)	Project stage	Start of operation (year)	Remarks
HyDeal Ambition (McPhy, 2021)	DH2/Dhamma Energy, McPhy Energy, Enagás, Gazel Energie, Cube, EIB, among others	Europe (Spain, France, Germany)	67 GW	3,600	Under development	2022-2030	Includes various market players and locations in Europe. The production of green hydrogen in Spain is planned to start in 2025.
AquaVentus (FuelCellsWorks, 2022) (AquaVentus, 2022)	Consortium incl. RWE, Vattenfall, Shell, E.ON, Siemens Energy, Vestas	Germany	10 GW	1,000	Announced	2025	Planning to generate at full capacity in 2035.
HyTech Hafen Rostock (RWE, sd)	Rostock EnergyPort cooperation GmbH, RWE Generation, EnBW Neue Energien GmbH, RheinEnergie AG and Rostock Port GmbH	Germany	0.1 GW	6.5	Announced	2026	
White Dragon (Collins L., 2020) (Polychroniou, 2022)	Among others: DEPA, DESFA, Hellenic Petroleum, Terna Energy, Damco Energy	Greece	5 GW	283	Announced	2029	Use of solar power.
Unnamed (Collins L., 2020)	EI-H2, Zenith Energy	Ireland	< 3.2 GW	240 (own estimate)	Feasibility study	2028	Use of 3.2 GW of offshore wind. A 500 MW green ammonia facility is planned.
Reckaz (FuelCellsWorks, 2022) (Rec-kaz, 2021)	SVEVIND group, ILF Consulting Engineers, Kazakh Government	Kazakhstan	30 GW	3,000	Announced	2028	At the end of 2021, a concept study for this facility was announced. Since then, no further news has been posted on the project website.
Aman (FuelCellsWorks, 2022) (Hollands, 2022)	Mauritania government, CWP Global	Mauritania	16-20 GW	1,700	Announced	Unknown	Unknown when it will start, but next steps in this project have been announced.

Project	Stakeholders	Country	Electrolyser capacity	Hydrogen production volume (kt/year)	Project stage	Start of operation (year)	Remarks
Nour Project (IEA, 2022) (Collins L., 2021)	Chariot	Mauritania	10 GW	1,730	MoU signed	Unknown	Offshore wind and solar power in desert regions.
Beijing Jingneng Inner Mongolia (Statista, 2021) (Brown & Grünberg, 2022) (World-Energy, 2020)	Beijing Jingneng Clean Energy Co.	Mongolia	5 GW	400	Under construction	Unknown (2021 was planned)	
NorthH2 (FuelCellsWorks, 2022) (NorthH2, 2022)	Groningen Seaports, Eneco, RWE, Equinor, Shell, Gasunie, OCI, Province of Groningen	Netherlands	>10 GW	1,000	Announced (Feasibility studies underway)	2027	Planning to generate at full capacity in 2040.
SeaH2Land (Collins L., 2020)	Orsted, ArcelorMittal, Yara, Dow Benelux, Zeeland Refinery	Netherlands and Belgium	1 GW	Not stated	Announced	2030	Use of a 2-GW offshore wind farm in the Dutch North Sea.
Green Energy Oman (FuelCellsWorks, 2022) (OQ, 2022)	OQ (Oman Oil Company), InterContinental Energy and EnerTech	Oman	14 GW	1,800	Announced	2038	
GreenH <sub>2</sub> Atlantic (Green H <sub>2</sub> Atlantic, 2022) (ENGIE, 2021)	Axelera, Bondalti, CEA, DLR< EDP, Efacec, ENGIE, Galp, ISQ, Inescotec, Martifer Group, McPhy and Vestas	Portugal	0.1 GW	10	Announced	2025	Located at the port of Sines. Start of construction planned in 2023 and completion expected in 2025.
MadoquaPower 2X (Klevstrand, 2022)	CIP, Madoqua Renewables, Power2X	Portugal	0.5 GW	50 + 90 (500 kton NH <sub>3</sub> )	Announced	Not stated	Located at the port of Sines.
Unnamed (Klevstrand, 2022)	NeoGreen, Frequent Summer	Portugal	> 0.5	Not stated	Announced	Not stated	Located at the port of Sines.
H2 Sines (Collins L., 2020)	EDP, Galp, Martifer, REN, Vestas	Portugal	1 GW	Not stated	Feasibility study	2030	Located at the port of Sines.
Neom Green Hydrogen	NEOM, Air Products,	Saudi Arabia	4 GW	Unknown	Under developmen	2026	1.2 million tonnes of green ammonia are produced from the

Project	Stakeholders	Country	Electrolyser capacity	Hydrogen production volume (kt/year)	Project stage	Start of operation (year)	Remarks
Project (ACWA Power, 2022) (FuelCellsWorks, 2022)	ACWA Power, ThussenKrupp				t (started in May 2022)		hydrogen to transport overseas.
Hydrogen City Project (Collins L. , 2022)	Green Hydrogen International, SpaceX	United States	60 GW	2,500	Announced	2026 (first 2 GW phase)	

Note: This table provides a non-exhaustive overview.

### 2.1.5 Production Conclusions

Currently, hydrogen is predominantly produced from fossil fuels (mostly natural gas). Four production pathways for green hydrogen have been identified: electrolysis (using renewable electricity), direct solar hydrogen production, biomass fermentation and thermochemical biomass conversion. Each pathway uses different conversion technologies, with energy efficiency and TRL varying widely (see Table 5). Considering these characteristics, electrolysis (with alkaline or PEM electrolyzers) and thermochemical biomass conversion (via thermal gasification) are the most promising green hydrogen production technologies in the short term.

In terms of availability, the electrolyser technology appears the most suitable solution, since the availability of sustainable biomass is limited. Hydrogen can be produced with renewable electricity by splitting pure water and then used to produce a wide variety of chemicals, plastics, and fuels (hydrocarbons). As such, this production method could help to decarbonise many industrial sectors, including national, regional and intercontinental transportation. However, with the current global production of green hydrogen being less than 0.1 Mt per year and the global fuel energy demand of international shipping near 95 Mt (equivalent) of hydrogen per year, the production capacity would need to increase significantly. Additionally, the demand from other industries needs to be considered.

Table 5. Summary of green hydrogen production pathways

Production pathway	Technology	Energy efficiency	Technology readiness level (TRL)
1. Electrolysis	Alkaline electrolyser	63-70% *	9
	PEM electrolyser	56-60% *	8-9
	SOEC electrolyser	74-81% *	3-5
2. Direct solar hydrogen production	Photo-electrolysis	10% **	1-3
	Thermolysis	20-45% **	3-4
	Biophotolysis	3-16% **	1-3
3. Biomass fermentation	Dark fermentation	60-80% ***	4
	Photo-fermentation	0.1% **	1-3
4. Thermochemical biomass conversion	Pyrolysis	35-50% ***	6
	Thermal gasification	52% ***	5-8
	Supercritical water gasification	80% ***	4

\*: Electricity-to-hydrogen  
 \*\*: Solar energy-to-hydrogen  
 \*\*\*: Biomass-to-hydrogen

## 2.2 Sustainability

In this section, the sustainability of green hydrogen production (using grey hydrogen as a reference to estimate GHG emissions reduction) and its use as a fuel in maritime ships is analysed. GHG emissions (subsection 2.2.1), air pollutant emissions (subsection 0) and other environmental impacts (subsection 2.2.3) are also examined. The sustainability aspects of hydrogen are summarised in subsection 2.2.4.

### 2.2.1 GHG Performance

#### *Life-cycle GHG emissions of hydrogen*

Since hydrogen does not contain carbon, it does not create any GHG emissions when combusted. Hydrogen-powered vessels using internal combustion engines only emit a small amount of GHG emissions in case a carbon-based pilot fuel<sup>2</sup> is used. It must be noted that, if a net zero carbon fuel is used as pilot fuel, these emissions can be eliminated. Pilot fuel is not needed when fuel cells are used.

The processes of hydrogen production and transportation are also associated with GHG emissions. The GHG emission volumes are much higher for grey hydrogen than for green hydrogen since natural gas is used as a feedstock to produce the former.

On the other hand, green hydrogen produced with water electrolysis and renewable electricity creates almost no GHG emissions. If electricity is obtained from the grid, the process is not considered fully renewable and the associated GHG emissions will depend on the mix of electricity generated during the operating hours of the electrolyser(s).

The provision of heat for a high temperature electrolyser may also contribute to the GHG emissions of green hydrogen. Sometimes, the GHG emissions associated with the production of electricity-generation units and electrolysers are included in the GHG emissions from green hydrogen. These emissions are spread out over the lifetime of the associated installations.

In case hydrogen is transported in the form of a hydrogen carrier (see as an example Liquid Organic Hydrogen Carriers in subsection 2.4.2), the energy needed to convert, store and reconvert the carrier into hydrogen may also cause GHG emissions, depending on the energy sources used to produce this energy. For example, transportation-related emissions may result from the onboard storage of hydrogen as a fuel. If hydrogen is transported in the form of liquid hydrogen, it needs to be cooled to -253°C. This process requires energy. In case this energy is produced through the combustion of fossil fuel, GHG emissions are associated with hydrogen storage. These emissions could be eliminated if renewable energy is used.

In case a carbon fuel is internally reformed into hydrogen in a fuel cell, CO<sub>2</sub> emissions are released during fuel cell operations (DNV GL, 2017). However, if hydrogen is the fuel that is bunkered and fed into the fuel cell, no CO<sub>2</sub> emissions are formed during the operational stage (ship propulsion).

In literature, the lifecycle GHG emission factors of renewable electricity and green hydrogen often include the emissions associated with the manufacturing and construction of wind turbines and/or solar panels. Since there are no emissions related to the generation of renewable electricity itself, the most significant contributions come from the manufacturing and construction of wind turbines and/or solar panels.

The lifecycle GHG emission factor of a fuel includes direct and indirect GHG emissions as well as any emissions of CO<sub>2</sub>, CH<sub>4</sub> and N<sub>2</sub>O which are converted to CO<sub>2</sub>-equivalents using global warming potential (GWP) factors. In Table 6, the GHG performance of green hydrogen is summarized, in comparison to grey and blue hydrogen and conventional marine fuels. It should be noted that Resolution MEPC.376(80), which contains the Marine Fuel Life Cycle GHG Guideline, includes different hydrogen production pathways (see rows 104-113 of Appendix I). As of today, these pathways have not been colour-coded, i.e., the hydrogen is not labelled as “grey”, “blue” or “green” hydrogen, depending on the pathway.

---

<sup>2</sup> Pilot fuel refers to the small amount of liquid fuel needed when operating a gas engine, for the safe ignition of the gaseous fuel.

Table 6. Lifecycle GHG emission factors for green hydrogen vs. fossil marine fuels

Fuel	Production pathway	GHG emission factor (g/MJ)	Source	Remarks
Grey hydrogen	Natural gas (SMR/ATR)	71-120	(Atilhan, et al., 2021) (Cetinkaya, Dincer, & Naterer, 2012) (Parkinson, 2019)	Upper and lower value from (Parkinson, 2019)
Blue hydrogen	Natural gas (SMR/ATR and CCS)	18-63	(Parkinson, 2019) (Atilhan, et al., 2021)	Lower value from (Atilhan, et al., 2021); higher value from (Parkinson, 2019).
Green hydrogen	Wind energy (electrolysis)	4-10		Lower value from (Parkinson, 2019); higher value from (Atilhan, et al., 2021).
	Solar energy (electrolysis)	9.3-30		Lower value from (Parkinson, 2019); higher value from (Atilhan, et al., 2021)
	Biomass (gasification)	2.1-61		Upper and lower value from (Parkinson, 2019)
VLSFO	-	92	(CE Delft, 2021) FuelEU Maritime proposal	Upstream emissions depend on crude oil source and refinery
MGO	-	91		

Note: SMR = steam methane reforming; ATR = autothermal reforming; CCS = carbon capture and storage; VLSFO = very low sulphur fuel oil; MGO = marine gasoil.

The liquefaction process for hydrogen, which is not included in the table above, can consume up to about 30% of its energy content (Atilhan, et al., 2021) due to the demand for electricity. Although, theoretically, hydrogen could be converted to electricity in a local turbine or fuel cell, it is more practical to use electricity from local renewable sources (other than hydrogen) or from the grid. Thus, the amount of GHG emissions produced depends on the electricity generation mix during the liquefaction process. The GHG output from using various forms of electricity have been reported as: 4.6g CO<sub>2</sub> eq/MJ hydrogen for wind; 11.7g for solar and 43.3g for electricity sourced from the grid, respectively (Atilhan, et al., 2021).

### GHG impact of hydrogen emissions

The lifecycle GHG impact discussed above does not consider the indirect GHG from hydrogen itself.

The Intergovernmental Panel on Climate Change (IPCC) has yet to quantify the indirect global warming effect of hydrogen emissions. However, it acknowledges the existence of this effect in its Sixth Assessment Report. Until now, only a few studies have addressed this topic. Therefore, a high level of uncertainty remains.

Hydrogen is the smallest chemical molecule in existence. Consequently, it could leak relatively easily from natural gas pipelines (if these were used to carry hydrogen) and other systems in the hydrogen supply chain. In addition, hydrogen may be emitted intentionally for multiple reasons. To remove impurities, for example, electrolysis uses venting during start-up, shutdown and purging during operations. In the worst-case scenario, this may lead to hydrogen emissions up to 9.2% of the volume produced.

Assuming that all the purged and vented hydrogen is captured and used (preventing its release into the atmosphere), hydrogen emissions from electrolysis would be less than 0.52%. For liquid hydrogen, the main leakage mechanism is boil-off, i.e., the vapourisation of liquid hydrogen. The boil-off rate (BOR) of hydrogen varies from 0.1-5% per day, with a typical rate of 1% per day. For larger applications, such as maritime vessels, it may be possible to reduce the hydrogen emissions by making use of reliquefaction plants onboard (such as with LNG) or by using it to generate heat or electricity.

The use of hydrogen in fuel cells may also result in releases through venting and purging, potentially adding up to 2.9%. The hydrogen emissions from combustion in internal combustion engines are likely to be negligible (Frazer-Nash Consultancy, 2022). The estimations of hydrogen emissions at different points in the hydrogen supply chain are summarised in Figure 3.

Air Liquide, a company that supplies industrial gases, has estimated that the future hydrogen losses from the supply chain when hydrogen is delivered by road to refuelling stations will be 3% of the delivered volume for gaseous hydrogen and 4-5% for liquefied hydrogen by 2030. A supply chain using pipelines to transport hydrogen could be expected to see losses in 2030 of less than 1% (JRC, 2022).

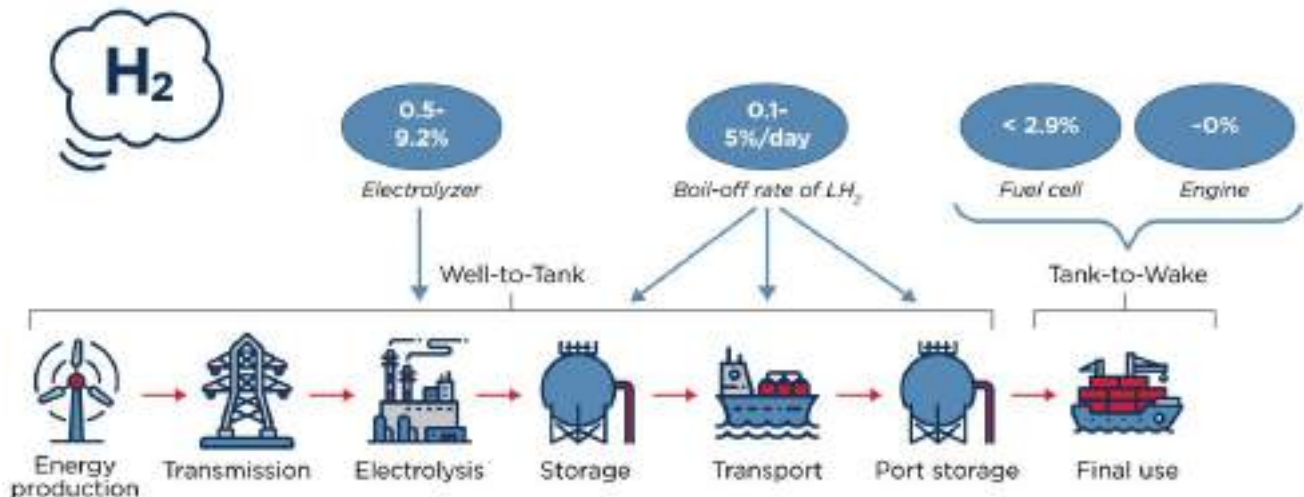

Figure 3. Hydrogen emissions along the hydrogen supply chain, based on estimations from Frazer-Nash Consultancy (2022). This supply chain examines the import of hydrogen by ship in the form of liquid hydrogen (LH<sub>2</sub>).

Primarily, atmospheric hydrogen is removed when absorbed in soils, but the proportion is highly uncertain. It is also removed by hydroxy radicals (OH) in the atmosphere. OH plays a vital role in the budget of tropospheric ozone. An important effect of any increase in atmospheric hydrogen -- and the subsequent decrease in OH -- is the increase of the lifetime of CH<sub>4</sub>, which is largely controlled by the reaction with OH. Lengthening the lifetime of CH<sub>4</sub> increases its radiative force and global-warming potential. Therefore, hydrogen can be considered an indirect GHG.

However, the increased use of hydrogen as a replacement of fossil fuels also will reduce the CH<sub>4</sub> emissions from fossil supply chains. The same holds for another hydrogen emission effect: more hydrogen in the atmosphere will lead to an increase in tropospheric ozone (another GHG); but reductions in the NO<sub>x</sub>, CO and VOCs emissions caused by fossil-fuel replacement will reduce the formation of tropospheric ozone.

A third indirect effect of atmospheric hydrogen on GHG emissions is that it will likely lead to an increase in stratospheric water vapour, which according to recent scientific insights (Warwick, et al., 2022) has an important indirect climate effect. Recent studies on the global-warming potential (GWP) of hydrogen over a period of 100 years (GWP<sub>100</sub>), published by Derwent et al. (2020) and Field & Derwent (2021), obtained values of  $5 \pm 1$  and  $3.3 \pm 1.4$  respectively, based on changes to the troposphere only.

Warwick et al (2022) obtained a total GWP<sub>100</sub> for hydrogen of  $11 \pm 5$ , partly due to the inclusion of the stratosphere in their study, which accounts for approximately 30% of the GWP. (For reference: the GWP<sub>100</sub> is 1 for CO<sub>2</sub>,  $29.8 \pm 11$  for fossil CH<sub>4</sub> and 27 for non-fossil CH<sub>4</sub> (IPCC, 2021).) One future global hydrogen economy scenario (in which 40% of final fossil energy consumption is replaced by hydrogen and in which a hydrogen leakage rate of 1% and 10% is assumed) found that the increase in GHG emissions from leakage would offset approximately 0.4% and 4% of the total GHG emissions reductions, respectively. Thus, the study by Warwick et al (2022) shows that the benefits from GHG emission reductions clearly outweigh the adverse effects from hydrogen emissions. Also, it emphasizes the importance of controlling hydrogen leakage in a hydrogen economy.

The GHG impact of hydrogen emissions is summarised in Table 7.

Table 7. GHG impact of hydrogen emissions

Aspect	Value	Source	Remarks
Global warming potential of hydrogen over a period of 100 years (GWP <sub>100</sub> )	5 ± 1	Derwent et al. (2020)	Based on changes to the troposphere.
	3.3 ± 1.4	Field & Derwent (2021)	
	11 ± 5	Warwick et al (2022)	Based on changes to the troposphere and stratosphere.
Share of GHG emissions reduction that is offset by hydrogen leakage.	0.4% (assuming a H <sub>2</sub> leaking rate of 1%)	Warwick et al (2022)	In a scenario in which 40% of final fossil energy consumption is replaced by hydrogen.
	4% (assuming a H <sub>2</sub> leaking rate of 10%)		

A recent summary report from the EC's Joint Research Centre highlighting the results of a Clean Hydrogen Joint Undertaking Expert Workshop (JRC, 2022) found that hydrogen is quite abundant in the atmosphere, and has an average lifespan of about two years. There are multiple natural and anthropogenic sources of hydrogen (emitters) and two natural sinks, of which soil uptake is the most important.

Air Liquide has estimated that a global hydrogen economy with a demand of 660 Mt in 2050 would lead to an increase of roughly 10% of overall hydrogen emissions into the atmosphere. Based on the estimation that the production of each kilogram of green hydrogen would save 10.9kg of CO<sub>2</sub> equivalents, the scenarios from workshop indicated that the switch to green hydrogen would reduce the climate impact from fossil fuels from 6095+% in the first decade. Over a period of 100 years, the climate impact from fossil fuels would be reduced by more than 80%, even if hydrogen losses were as high as 10%. This outcome is in line with (Warwick, et al., 2022). However, the report warns that a switch to blue hydrogen may have a negative climate impact and increase global temperatures (JRC, 2022).

Ocko & Hamburg, 2022 warn that the leakage of hydrogen emissions “can considerably undermine the climate benefits of decarbonisation strategies that involve clean hydrogen”. The authors conclude that more research needs to be done to quantify the indirect global-warming effects of hydrogen emissions and hydrogen leakage rates; they warned that mitigation measures to protect against leaks must be identified and prepared for before the hydrogen economy is developed on a large scale.

Based on the above literature review, it is concluded that the switch to a hydrogen economy can be expected to lead to a net reduction in GHG emissions.

## 2.2.2 Air Pollution

Burning conventional fossil fuels on ships results in the emission of air pollutants, which can be damaging to the health of the crew and/or the local environment. The volume of air pollutant emissions released by hydrogen-powered vessels depends on the engine system, design features and the amount and type of pilot fuels used.

### *Internal combustion engines*

In case hydrogen is used in a marine internal combustion engine, no emissions of sulphur dioxide, carbon monoxide, heavy metals, hydrocarbons, polycyclic aromatic hydrocarbons (PAHs) and particulate matter (PM) arise from the combustion itself. The reason is that hydrogen fuel contains no carbon, sulphur and other contaminants, which are typically seen in conventional residual or distillate fuels. However, some sulphate, hydrocarbon and PM emissions are expected to arise from the combustion of pilot fuel and from the cylinder oil applicable to specific engine designs. Pilot fuels are needed as an ignition source in case the hydrogen is burned in an internal combustion engine. Pilot fuel could take the form of fossil diesel, e-diesel or biodiesel, the total amount of which is limited to 1 to 3% of total fuel use (HyMethShip, 2019). Furthermore, the burning of hydrogen can lead to the thermal formation of nitrogen oxides (NO<sub>x</sub>) via a mechanism that also applies to the combustion of fossil fuels.

By careful control of the conditions for combustion, the NO<sub>x</sub> emissions may be reduced. However, this may lead to reduced power output and performance. Aftertreatment for the removal of NO<sub>x</sub> is another possibility onboard ships, which increases the cost and complexity of the appliances. With good control of the combustion conditions and SCR



aftertreatment, the NO<sub>x</sub> emissions from hydrogen combustion in marine engines becomes insignificant (McKinsey & Company, 2021). According to Lewis (2021), hydrogen in internal combustion engines is “likely to outperform heavy fuel oil equivalents” regarding NO<sub>x</sub> emissions.

It must be noted that the control of NO<sub>x</sub> emissions from international shipping is regulated through Annex VI Regulation 13. See subsection 3.2.2.2 for the international regulations for air pollution under MARPOL Annex VI.

### *Fuel cells*

Using hydrogen as a fuel in an onboard fuel cell system would reduce the air pollutant emissions even further than hydrogen use in an internal combustion engine because fuel cells have no incomplete combustion products; they also have a higher efficiency than internal combustion engines and no pilot fuel is needed. With this propulsion technology, the emissions of NO<sub>x</sub>, SO<sub>x</sub> or PM can be eliminated.

For the Molten Carbonate Fuel Cell (MCFC), Phosphoric Acid Fuel Cell (PAFC), Solid Oxide Fuel Cell (SOFC) and High-Temperature Proton Exchange Membrane Fuel Cell (HT-PEMFC), a low amount of NO<sub>x</sub> emissions may form in their heat and energy-recovery systems if a carbon fuel is used to internally reform into hydrogen. If hydrogen is used as a fuel, no NO<sub>x</sub> emissions are formed (DNV GL, 2017).

Sandia National Laboratories conducted a feasibility study on a high-speed passenger ferry powered by hydrogen fuel cells and determined that, by using fuel cells and renewable hydrogen, NO<sub>x</sub> emissions would be reduced by 99.2% and PM emissions by 98.6%, compared to a diesel-powered ferry (AccessScience, 2019).

In general, the emission levels of gaseous and particulate air pollutants arising from the use of hydrogen as a shipping fuel are lower than those from conventional fossil fuels (see Table 8 in subsection 2.2.4).

For more details on fuel cells, see subsection 2.4.6.

## **2.2.3 Other Environmental Impacts**

### *Renewable electricity generation*

Generating renewable electricity to produce green hydrogen requires significant land or sea surface areas. The amount varies widely across regions, depending on the incoming solar radiation and prevailing wind speeds. To realise large-scale green hydrogen production, solar-energy plants and wind farms also would need to be built on a large scale. If solar energy parks and onshore wind parks are located where the cultivation of food crops is not possible, their creation will not interfere with food production, preventing indirect changes in land use and the related environmental damage. There are arid regions around the world where this is the case (e.g., northern Chile, western Australia, northeast Brazil, northern Africa, parts of the U.S. and China). Some regions (e.g., northern Europe, the eastern US and western Africa) have seas that are suitable for offshore wind farms. However, these may have an impact on marine ecosystems.

### *Wind parks*

Chowdhury et al (2022) have examined the environmental impacts of wind parks. Manufacturing is the main source of environmental impact from wind turbines; operation has the lowest impact. The impact of the end-of-life stage (decommissioning) can be significantly reduced by recycling steel and fibreglass from the turbines.

Residual copper, which is a main element in the wind turbine generator, can accumulate in plants and animals and create metabolic disturbances and inhibit plant growth.

During operations, wind turbines can harm birds and bats. However, there is not enough evidence on the full impact on those species. Moreover, during the construction phase for wind turbines, wildlife may be harmed, and the breeding of birds and bats may be hampered. The noise from the construction and the operation of wind turbines may cause birds and bats to relocate their habitats. To reduce these negative impacts, the location of bird and bat habitats should be considered when selecting a location for a wind park.

Offshore wind turbines may also affect marine mammals. For example, there is evidence that Minke whales have been stranded due to noise from wind turbines. Additionally, the noise at wind turbine sites could cause residents and wind turbine workers to suffer from sleep disorders. Also, the change in landscape may influence residents' mental health.

Finally, wind parks have the potential to reduce the kinetic energy of local winds so dramatically that it may cause local impact similar to the greenhouse effects caused by increased moisture evaporation, although research suggests that spatial and temporal impacts such as these are relatively minor (Chowdhury, et al., 2022).

### *Solar parks*

For solar parks, there are negative environmental effects associated with the manufacturing, construction and disposal of photovoltaic panels and other technologies used to generate solar electricity, but the negative effects from operations are less prevalent than for wind parks.

In one study (Armstrong, Ostle, & Whitaker, 2016), the impact of photovoltaic arrays at a solar park in the UK sited in species-rich grassland was analysed. It was found that the photovoltaic arrays caused seasonal and diurnal variation to air and soil microclimates, including plant diversity and fluxes in CO<sub>2</sub> within the ecosystem. During the summer, a cooling of up to 5.2°C was observed and the diurnal variation in temperature and humidity was reduced under the photovoltaic arrays. Photosynthesis and net ecosystem exchange in spring and winter also were lower under the photovoltaic arrays. More research is needed to better understand the environmental effects. The authors concluded that by optimising the design and management of the solar park, environmental costs could be minimised.

### *Electrolysers*

Although there is limited information on the environmental impact of large-scale electrolysers used to produce green hydrogen, a recent study by Delpierre, Quist, Mertens, Prieur-Vernat, & Cucurachi (2021) shed some light on this topic. The authors compared the environmental performance of green hydrogen production using alkaline electrolysers, PEM electrolysers and SMR, using ex-ante Life Cycle Assessment (LCA) for a 2050 scenario in the Netherlands.

The contribution of the electrolyser to the environmental impact was limited to 10% in all categories of impact, including acidification, climate change, land use, eutrophication, resource depletion, ozone depletion and photochemical ozone formation). More than 80% of the environmental impact came from the production of electricity in the Dutch system.

Secondly, when the electricity used by the electrolysers came from wind energy, SMR performs better than large-scale electrolysers for water-resource depletion and mineral, fossil and renewable-resource depletion, but worse for the other categories.

The production of green hydrogen by means of electrolysis requires pure, deionised water. The amount of water needed to produce green hydrogen can increase water scarcity if freshwater is used. On the other hand, if seawater is used to produce deionised water, the intake of seawater and the rejection of brines can be detrimental to ocean biodiversity and marine life (Ghavam, Vahdati, Grant Wilson, & Styring, 2021).

### *Fuel cells*

In a lifecycle analysis of a 1 kW PEM fuel cell system, Stropnik, Lotrič, Bernad Montenegro, Sekavčnik, & Mori, 2019) found the environmental impact of the manufacturing phase to be larger than the operating phase for eight of 11 environmental impact indicators when fuel cells use green hydrogen produced from electrolysis.

The major environmental impact from the manufacturing phase is related to the fuel cell stack, where most of the critical materials are used. Here, platinum has the largest impact: Although the 1 kW PEM fuel cells require only 0.75 grams of platinum, this amounts on average to 60% of the total environmental impact of the manufacturing phase. In the balance-of-plant system, the highest impact comes from chromium steel, aluminum and high-density polyethylene (HDPE).

If proper recycling measures are taken for each of the materials, the environmental impact of 1 kW PEM fuel cell system could be reduced by 37.3% for the manufacturing phase and by 23.7% over the entire life cycle. In the

manufacturing phase, recycling on this level also could reduce the acidification potential of the fuel cell system by 70.7% (Stropnik, Lotrič, Bernad Montenegro, Sekavčnik, & Mori, 2019) due to the smaller use of virgin platinum; the extraction of platinum causes large emissions of sulphur oxide (Garraín & Lechón, 2014) (Garraín & Lechón, 2014).

Furthermore, if research and development improve the duration of the fuel cells used in maritime applications, their environmental impact will diminish accordingly. Finally, the replacement of conventional marine engines with fuel cells will contribute to noise reduction from marine ships (DNV GL, 2017).

### *Production pathways using biomass*

A large part of the environmental impact from the production pathways that use biomass (pathways 3 and 4, as described in 2.1.2) is linked to the cultivation of biomass. This is most relevant for bio-energy crops, but it also could be significant for residual biomass feedstock (although the way any environmental impacts are allocated to different output streams plays a role). The type of biomass feedstock that is used has a large influence on the nature and size of the lifecycle environmental impacts for the bio-based production pathways for hydrogen.

The technology used for biomass gasification is the most advanced. Any adverse environmental effects may be linked to contaminants in the biomass feedstock that is used, and emissions to air and water. Substantial adverse effects are the generation of fly ash, dust, gaseous emissions and water pollution. The wastewater from cooling and cleaning syngas may include contaminants such as phenolic and tarry components, which may damage ecosystems. The ash that remains after gasification can react with other substances in landfills. Also, fire, gas leaks and carbon monoxide poisoning are considered primary hazards of gasifier use (Barahmand & Eikeland, 2022).

No specific information has been found on the biomass pyrolysis pathway for green hydrogen production<sup>3</sup>. Nevertheless, as the pyrolysis process is similar to the gasification process, similar environmental risks are likely to exist.

In a dark fermentation case study based on a feedstock mix of sewage sludge and wine vinasse (a by-product of wine distillation), the largest lifecycle impact was found to be marine eutrophication, which originates when nitrogen-based fertilisers are used in vineyards. In another dark-fermentation case study based on sugar beet molasses (a byproduct of sugar production), large environmental impacts were found from marine eutrophication, terrestrial acidification, terrestrial eco-toxicity and water consumption. Most of these relate to the life-cycle phase of biomass cultivation, but the eco-toxicity effect is related to emissions from electricity production and fuel consumption (Camacho, Estévez, Conde, Feijoo, & Moreira, 2022).

### *Direct solar hydrogen pathways*

Since the production processes in the direct solar hydrogen pathway (production pathway 2 as described in subsection 2.1.2) are in an early stage of development, there is not much public information about the associated environmental impacts. On the photo-electrolysis route, photoelectrochemical cells are used with, for example, photovoltaic cells to generate electrical energy.

In case of the thermolysis route, solar heat collectors or other renewable energy production units must be manufactured and installed to generate the very high process temperatures. Metals and other earth resources are needed to manufacture these units; the associated mining processes may have negative effects such as erosion, terrestrial eco-toxicity and water pollution.

## **2.2.4 Sustainability Conclusions**

In the well-to-tank phase of the green hydrogen lifecycle, the GHG emissions are close to zero. Only building the electricity-generation units and electrolyzers contribute to the well-to-tank GHG emissions.

In case hydrogen gas is released into the atmosphere, it has an indirect GHG impact. It may leak from any natural-gas pipelines used to transport it, from storage tanks, during boil-off processes, via any venting that is conducted

---

<sup>3</sup> Biomass pyrolysis is mainly developed to produce biofuels, not hydrogen, which complicates the gathering of environmental impact data on this pathway.

during start-up and shutdown and from purging during operations to remove impurities. However, Warwick et al (2022) have estimated that any increase in GHG emissions from leakage offsets approximately 0.4% of the emissions reduced when conventional fuels are replaced with hydrogen if a leakage rate of 1% is assumed. Clearly, the lower GHG emissions created when hydrogen replaces conventional fuels outweighs the adverse effects of hydrogen leaks.

When hydrogen is used in an internal combustion engine for shipping no GHG emissions are generated beyond those created from the combustion of pilot fuels. If a net zero carbon fuel is used as pilot fuel, then the fuel-related well to wake GHG emission can be eliminated. Furthermore, no emissions of sulphur dioxide, carbon monoxide, heavy metals, hydrocarbons, polycyclic aromatic hydrocarbons and particulate matter arise from the hydrogen combustion itself. The combustion of hydrogen can lead to thermal formation of NO<sub>x</sub>, which will be insignificant if there is adequate control of the combustion conditions and an SCR aftertreatment system is installed.

Using a hydrogen fuel cell system can eliminate the emission of NO<sub>x</sub>, SO<sub>x</sub> or PM, since fuel cells have no incomplete combustion products, and since no pilot fuel is needed. In cases where carbon fuel is used and reformed to hydrogen inside the fuel cell, a low amount of NO<sub>x</sub> emissions may be formed in the heat and energy recovery systems.

Another point is that the regulatory framework could be further enhanced: Limits for fugitive hydrogen emissions from internal combustion engines and fuel cells could be introduced in the NO<sub>x</sub> technical code, as indicated in Chapter 3.

Table 8 below summarises the level of lifecycle GHG and air-pollutant emissions generated by using hydrogen as a marine fuel and compares this to using fossil marine fuels.

Table 8. Lifecycle GHG emissions and air-pollutant emissions from green hydrogen vs fossil marine fuels

	HFO, MGO*	LNG*	Green hydrogen - combusted in engines	Green hydrogen – used in fuel cells
<b>Lifecycle GHG emissions</b>				
N <sub>2</sub> O	Present	Present	Not present	Not present
CH <sub>4</sub>	Low	Present at Otto engines	Not present	Not present
CO <sub>2</sub>	Present	Present	From manufacturing wind turbines and solar panels	From manufacturing wind turbines and solar panels
H <sub>2</sub> (indirect)	Not present	Not present	From venting, purging and boil-off	From venting, purging and boil-off
<b>Air pollutant emissions</b>				
SO <sub>2</sub> and metals	Present	Not present	Not present	Not present
Carbon monoxide and hydrocarbons	Present	Present or increased	Not present	Not present
VOCs and PAHs	Present	Reduced	Not present	Not present
NO <sub>x</sub>	Needs SCR for Emission Control Area	Otto engines meet Emission Control Area without SCR	No significant NO <sub>x</sub> emissions with SCR	Not present
Direct particulate matter	Present	Reduced	Not present	Not present

Notes: HFO = heavy fuel oil; LNG = liquefied natural gas; MGO = marine gas oil; SCR = selective catalytic reduction.

\*: Adapted from (Ash & Scarbrough, 2019). Pilot fuel is not considered in this table.

To produce green hydrogen on a significant scale, large amounts of land are needed for wind and solar parks. It is becoming increasingly challenging to find enough land for onshore wind and solar energy projects. Eligible land is often useful for agriculture and biodiversity conservation as well (McKinsey and Company, 2023). Thus, indirect land

use change and related environmental damage such as biodiversity loss may occur if wind and solar capacity is expanded at the expense of agriculture or nature conservation.

Manufacturing wind and solar parks, electrolysers and fuel cells all generate negative environmental impacts. The construction and operation of wind farms may affect the habitats of birds and bats.

The environmental impact of building solar parks has not received a significant amount of study as yet. However, research by Armstrong, Ostle & Whitaker (2016) indicated that photovoltaic arrays can cause seasonal and diurnal variation in air and soil microclimates. The contribution of the electrolyser manufacturing to the total environmental impact of green hydrogen production is limited to 10%, while more than 80% of environmental impact comes from the production of electricity (Delpierre, Quist, Mertens, Prieur-Vernat, & Cucurachi, 2021)

To manufacture a 1 kW PEM fuel cell system, the use of platinum generates on average about 60% of the total environmental impact. Recycling materials could reduce the environmental impact of the manufacturing phase by about 37% (Stropnik, Lotrič, Bernad Montenegro, Sekavčnik, & Mori, 2019).

## 2.3 Availability

To produce enough green hydrogen to power maritime shipping, its production capacity -- and that of renewable electricity -- would both need to undergo tremendous growth. The current global capacity of wind and solar parks is relatively low; this holds even more true for global electrolyser capacity<sup>4</sup>. It should also be taken into account that the demand for renewable electricity and green hydrogen is expected to rise across virtually all economic sectors (see subsection 2.3.3), so the associated production capacity would need to increase far beyond the levels required for the maritime sector.

The size of global electrolyser capacity relative to the capacity of wind and solar parks will have an impact on the operational scheme and profitability of the overall power system. In case the electrolyser is directly connected to a wind or solar park, for example, customising it to the maximum power output of the wind/solar park would create a system with a low load factor and hydrogen output.

However, by connecting the electrolyser to the grid and using the grid's electricity when winds and solar irradiation are low, the electrolyser's load factor can be increased, reducing the capacity required to obtain the same amount of hydrogen. An alternative way to increase the load factor is to 'over dimension' the wind/solar park and feed excess electricity into the grid. This is illustrated in Figure 4.

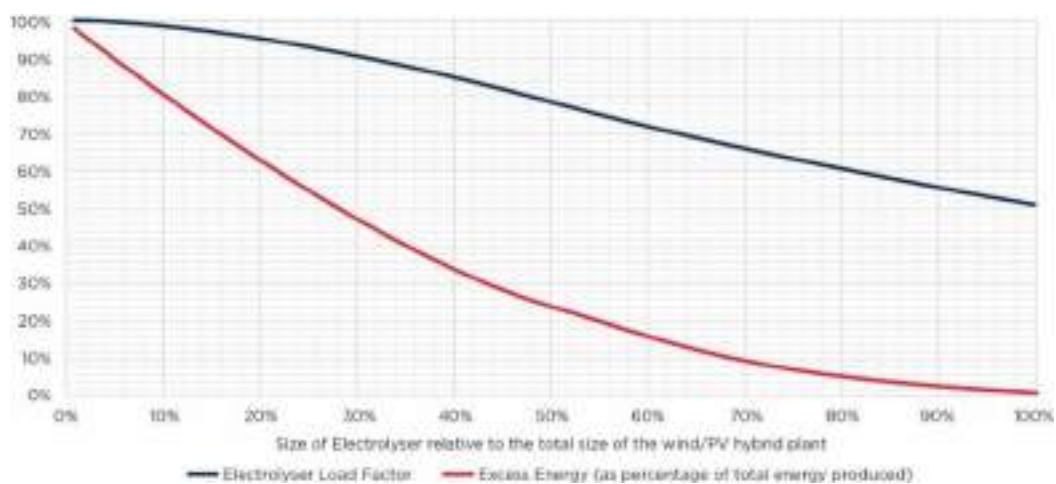

Figure 4. The relationship between the electrolyser's load factor and excess renewable electricity, given the sizes of the system and wind/solar park (IEA, 2017)

<sup>4</sup> The installed global renewable electricity capacity in 2020 was 2,800 GW (with more than 1,200 GW from hydropower), and the current installed global electrolyser capacity is about 200 MW (Aurora, 2021).

The need for grid connectivity to achieve competitive price levels for e-fuels was demonstrated in a recent study by (Nami, Butera, Campion, Frandsen, & Hendriksen, 2021; Münster, 2021). According to Nami et al. (2021), the electrolyser needs to be continuously operating at maximum capacity to encourage a profitable business case (although profitability will largely depend on the electrolyser operator's electricity costs and the market price for green hydrogen).

The use of grid-connected electrolysers creates the need for reliable certification schemes to ensure that the electricity used, and hydrogen produced can be considered 'green'. The European Commission published a draft Delegated Act in May 2022, which includes rules on when hydrogen produced via electrolysis can be called 'green'. The CertifHy initiative developed a green and low-carbon hydrogen certification system, which aims to enable cross-border trade of green hydrogen within the EU.

Furthermore, a continuous electrolyser operation would require hydrogen-storage facilities to be developed. When the hydrogen produced cannot be distributed, storage facilities will be needed to support continuous production. From a systems perspective, the development of a national hydrogen pipeline network and underground storage (for example, in empty salt caverns) probably would be the cheapest option.

### 2.3.1 European Availability

It is theoretically possible to develop the capacity to produce green hydrogen all over the world. Renewable electricity could be produced at most locations with favourable conditions for wind and solar irradiation. The cost savings from production at these locations would easily outweigh the additional costs associated with the intercontinental transport of renewable energy carriers. In this light, it is better to examine the potential worldwide capacity for green-hydrogen production than to look solely at the availability in Europe.

Nonetheless, in 2019, Europe had a capacity of 475GW for renewable electricity, with wind, solar and hydro each having a large share (Errard, Diaz-Alonso, & Goll, 2021). Given the EC's proposal in the 'Fit for 55' package to raise the EU's renewable energy target from 32% to 40% by 2030, the development of wind and solar power will need to be accelerated. Also, as explained in Section 3, FuelEU Maritime incentivises the use of renewable fuels of non-biological origin, requiring member States to ensure that the required bunker infrastructure is available in ports.

In addition, the EU has the ambition to develop 40GW of electrolyser capacity by 2030. So far, its member states have pledged 34GW by 2030 (Aurora, 2021).

A non-exhaustive list of large production projects for green hydrogen worldwide is given in Table 4.

### 2.3.2 Worldwide Availability

The amount of green hydrogen that may become available for the global maritime shipping industry is difficult to estimate, because it is subject to market developments, such as industry investment plans, changes in demand for renewable electricity and hydrogen and technological advances in wind and solar parks and electrolysers.

Some insight, however, arises from calculating the global capacity needed to supply enough green hydrogen to meet the final energy demands of maritime shipping in 2040 and comparing that to projected developments in production capacity. This exercise is described below and summarised in Table 10.

The final energy demand of global maritime shipping is projected to be 12.1-14.2 EJ in 2030, and 10.2-23.2 EJ by 2050 (IMO, 2020) (CE Delft & RH DHV, 2020). If hydrogen is assumed to be the only fuel used in maritime shipping and a linear development of demand is assumed, global hydrogen demand from shipping will reach 93-156 Mt/year by 2040. This is at least five times more than what could be produced by all announced electrolyser projects worldwide. Announced global electrolyser production capacity reached 260 GW by October 2021 according to the IEA (2021). However, first years of operation are not shown, and the final investment decision has yet to be taken in most of the electrolyser projects.

In comparison, a report from Aurora (May 2021) estimated that about 213.5 GW of electrolyser capacity would be delivered globally by 2040, 85% of which was in Europe (Aurora, 2021). With an electrolyser capacity of 213.5-260 GW, 17-30 Mt/year of green hydrogen could be produced, assuming an annual electrolyser load factor of 4,000-6,000 hours.

The 260 GW of announced electrolyser capacity is much higher than the worldwide capacity in 2020, which was 0.3 GW. It is also higher than the sum of the electrolyser projects planned for the 2021-2026 period, which is 16.7 GW. About 85% of these projects are in China, Chile, Spain and Australia. However, the largest part of the announced 260 GW in electrolyser projects is in Europe, a result of the EU's ambitions and policies aimed at reducing GHG emissions (IEA, 2021).

To estimate the electrolyser capacity required to enable a complete switch of maritime shipping to green hydrogen, an energy efficiency of 65% (based on lower heating value) and 4,000-6,000 full-load hours of the electrolysers is assumed. Under those conditions, 1,190-1,330 GW of electrolyser capacity would be needed to produce enough green hydrogen to supply the entire maritime sector.

Similar calculations can be made to make projections of the supply and demand for renewable energy. Assuming an electrolyser efficiency of 65% (based on lower heating value), 4,760-7,990 terawatt hours (TWh) of renewable electricity would be needed in 2040 to enable shipping's global switch to green hydrogen. This level of demand is in the same range as the current global production of renewable electricity: The worldwide production of renewable electricity in 2018 was about 6,600TWh, 63% of which was from hydropower, 19% from wind, 8% from bioenergy, 9% from solar and 1% from geothermal (IRENA, 2020).

However, renewable electricity would be mainly used to satisfy electricity demand. Therefore, its production would need to more than double to enable a complete switch of maritime shipping to green hydrogen. This doubling of renewable energy capacity is a big challenge as it needs to go hand in hand with the upgrade of renewable electricity production for other industries.

Some projections for the global production of renewable energy in 2030 and 2050 are listed in Table 9. Summarising these volumes into a range and interpolating between the projected years produces a projected global renewable electricity production of 15,000-30,000 TWh in 2040<sup>5</sup>, indicating that production would need to increase by a factor of 2-5 between 2018 and 2040. In theory, these volumes would enable the complete switch to green hydrogen in the maritime sector. In practice, a large share of the renewable electricity that is produced will feed into the power grids to supply worldwide demand for renewable electricity.

Table 9. Projections of global renewable electricity production from various scenarios (TWh/year) (CE Delft & RH DHV, 2020)

Scenario	2030		2050	
	Min	Max	Min	Max
IEA, 2°C Scenario	14,500		28,700	
IPCC RCP2.6 scenarios	6,300	13,100	22,200	28,100
IRENA REmap Case	20,400		47,400	
IEA, Beyond 2°C Scenario	14,500		31,800	
IPCC RCP 1.9 scenarios	8,100	14,700	31,200	49,100

<sup>5</sup> When assuming that the renewable electricity generation produces 40% of the time (which is representative for wind power), this translates to 4.3 to 8.6 TW of generation capacity.

Table 10. Availability of green hydrogen, renewable electricity and electrolyser capacity for global maritime shipping in 2040

Item/Aspect	Required*		Available in 2040		Unit	Remarks
	Min	Max	Min	Max		
Renewable electricity	4,760	7,990	15,000	30,000	TWh/year	Available volume estimated using global scenario values shown in Table 9 (interpolated from 2030 and 2050).
Electrolyser capacity	1,190	1,330	213.5	260	GW	Required volume calculated assuming 4,000-6,000 full-load hours. 213.5 GW is planned for delivery by 2040, globally (Aurora, 2021). When the 260 GW given by IEA (2021) is fully operational is not indicated.
Green hydrogen	93	156	17	30	Mt/year	Required volume calculated using CE Delft & RH DHV (Bio-Scope. Use and availability of sustainable biomass, 2020).

Note: 'Required' refers to the quantity needed to supply 100% of global maritime shipping in 2040 with green hydrogen.

Recently, IMO (MEPC) decided to include into the levels of ambition of the Revised GHG Strategy that at least 5% of the energy used by international shipping has zero or near-zero GHG emissions by 2030, and that a share of 10% should be pursued. This is expected to incentivise governments worldwide to facilitate the development of production capacity of green hydrogen and hydrogen-based fuels and of port infrastructure.

### 2.3.3 Link with Other Sectors

Maritime shipping's share of global energy consumption is limited (about 1.6% in 2019); its global energy demand is about 10 EJ/year (IRENA, 2021), whereas global primary energy consumption was 624 EJ/year (Roser, 2017).

If only global oil consumption is considered, the maritime sector has a higher share: in 2018, 6.8% of global final consumption was from navigation (IEA, 2020)

Industry (petrochemical, iron and steel, minerals, etc.), the residential sector, agriculture and fishing, the commercial and public services sectors and road transportation all had higher shares of global energy consumption than the maritime sector.

All sectors are facing the challenging task of moving towards net zero GHG emissions by 2050, with renewable electricity from wind, solar, hydro and geothermal energy being attractive alternatives to fossil fuels.

Renewable electricity could be directly used, for example, by electric road vehicles or electric boilers and furnaces in the industry; or indirectly, it could be used to produce e-fuels such as ammonia, methane, methanol, diesel and kerosene. Therefore, it is certain that shipping will face fierce competition with these other sectors for the use of renewable electricity and green hydrogen.

Theoretically, there are more than enough suitable locations to produce renewable electricity to meet global energy consumption. However, there is a limit to the speed at which economies can build solar and wind parks, conversion systems and transport and distribution infrastructure. Workforces, construction equipment, available capital and the minimum duration for permitting and project development processes, all presently constrain the speed at which the capacity can be increased.

In case the growth of renewable electricity production does not keep pace with the increasing demand for renewable electricity, scarcity will raise electricity prices, potentially making the production of green hydrogen too expensive to be a viable alternative to fossil marine fuels, especially if other sectors are willing to pay more.

To secure the availability of renewable electricity, the maritime shipping sector could develop dedicated wind and solar projects to guarantee a share of renewable electricity. Some initiatives are being put forward in that direction (Seroff, 2020; Maersk, 2022), which demonstrate the shipping industry's increasing awareness of the challenges ahead.



### 2.3.4 Availability Conclusions

To enable the large-scale production of green hydrogen for the maritime industry, the production capacity of renewable electricity -- and especially the installed capacity of electrolyzers -- will need to grow tremendously.

Whereas the anticipated worldwide availability of renewable electricity in 2040 appears to be sufficiently large to produce green hydrogen (using electrolysis) to cover the energy needs of the entire global maritime fleet, the worldwide electrolyzer capacity in 2040 is not expected to be sufficient to produce the amount of hydrogen required. There is a limit to the speed at which economies can build solar and wind parks and electrolyzers, which will restrict the availability of green hydrogen, especially in the short to medium terms.

Furthermore, it should be noted that the shipping sector will need to compete with all other sectors for renewable electricity and green hydrogen.

## 2.4 Suitability

Hydrogen has the potential to be a fuel for the shipping sector in the longer term due to its zero-carbon content and its potential to be produced from renewable sources.

This section will highlight some of the principal technologies and systems presently used to carry and consume hydrogen as fuel in the marine sector, the technologies deployed for burning other low-flashpoint fuels and gases and how those can be applied to support hydrogen's use as a marine fuel.

### 2.4.1 Storage, Distribution and Production

While the economic feasibility of using hydrogen in fuel cells, internal combustion engines and turbines is comparatively straightforward, the storage and distribution of hydrogen in either gaseous form via pipelines or in liquefied form and transported in LH<sub>2</sub> carriers is expected to be the most challenging part in a hydrogen economy. The distribution and storage costs will need to be lowered before they become drivers for hydrogen's adoption. Therefore, when production facilities for renewable fuels are being planned (similar to wind and solar parks needing to be located near suitable solar and wind conditions) their proximity to ports or pipeline grid connections will be critical to their commercial success. This would lower demand for intermediate storage and contribute to lower production costs, as this phase of storage could prove to be a relatively high component of the fuel's total cost. This strategy should help to ensure a rapid distribution of fuels, i.e., ammonia, methanol or hydrogen, at lower costs.

In most applications, storage of hydrogen fuel is in gaseous phase using pressurised tanks at 200-700 bar, or a two-to-three times higher pressure level than used in industrial hydrogen storage (which is typically less than 200 bar). Density of gas hydrogen at pressurised conditions of 700 bar and under ambient temperature is approximately 50 kg/m<sup>3</sup>. At liquid phase, under atmospheric pressure and boiling point (-253°C) it reaches approximately 71 kg/m<sup>3</sup>.

Hydrogen stored in insulated pressure vessels is also known as 'cryo-compressed' hydrogen. Liquefied hydrogen tanks at low pressures can be susceptible to pressure build-up when temperature rises, and the liquid hydrogen begins to vapourise and boil off. For this reason, protection from pressure build-up -- such as pressure-relief valves and/or arrangements using Thermal Pressure Release Devices (TPRD) -- should be in place for gaseous and liquefied hydrogen tanks.

Pressurised tanks made of steel can become rather heavy; for this reason, they are mostly designed using composite materials, which offer significantly reduced weights. For hydrogen, composite materials of polymeric matrix with fibre reinforcements are mostly used due to their excellent mechanical properties. These fibres are typically made of carbon, metal, ceramic and glass, or natural fibres such as sisal, hemp or flax. While fibres are used to reinforce the tank system and reduce the overall weight, the availability of these composite tanks is limited and small in capacity compared to the volumes needed for the shipping industry, especially those installed onboard vessels engaged in longer routes. As a result, the tanks will need to be combined in batches to store sufficient fuel capacities, increasing the risk of leaks through their valves and pipes.

In 2021 the very first voyage carrying liquid hydrogen was completed, demonstrating long distance liquid hydrogen transportation including loading and offloading processes. The ship, *Suiso Frontier*, is an LH<sub>2</sub> carrier capable of carrying 8,000 tonnes/1,250 m<sup>3</sup> of hydrogen; the design was created by Kawasaki Heavy Industries as part of the joint venture, called [HySTRA](#).

Liquid hydrogen is stored at  $-253^{\circ}\text{C}$  under atmospheric pressure, conditions that correspond to the best volume efficiency. However, the tanks may require significantly thicker insulation layers, two or three times the thickness of the thermal insulations used for Type C LNG tanks. Spherical shaped tanks are preferred as they have a low boil-off rate (best surface to volume ratio among other tanks) and reduce the power required to perform the reliquefaction that turns the hydrogen vapours into liquid hydrogen.

Aside from thermal insulation, vacuum-insulated Type C tanks could be considered to store liquefied hydrogen. A liquid hydrogen tank was developed for the *Suiso Frontier* as part of the [HESC](#) project. According to HESC (2023), the liquid hydrogen tank had a double-shell structure with vacuum insulation between overlapping inner and outer layers supported by high-strength plastic, reinforced by glass fibres. The ship was equipped with a gas combustion unit to burn excess boil-off gas from the liquid hydrogen tank (Australian Transport Safety Bureau, 2022).

Prior to admitting liquid hydrogen into any system, the entire system would need to be purged with air, oxygen and/or other oxidisers. The system also must be purged from hydrogen (gas-free) before exposing it to the atmosphere. This avoids the formation of flammable gas mixtures.

There are also challenges associated with liquid hydrogen's cryogenic temperature: a potential leakage on steel plate would cause brittle fracture. There is an increased risk of ice formation, either indirectly from low wall temperatures in the enclosure or directly when hydrogen is released. Ordinary atmospheric gases such as oxygen and nitrogen will liquefy or solidify upon contact with cryogenic liquid hydrogen, potentially forming impurities or unwanted build-ups in the fuel.

Helium, an inert, nonreactive noble gas, should be used to purge liquid-hydrogen systems. For gaseous hydrogen systems above  $-193^{\circ}\text{C}$  ( $-316^{\circ}\text{F}$ ), a noble gas or nitrogen can be used for evacuations.

Due to the very small molecular size of hydrogen, the gas can disperse through the walls of containment systems and permeate into certain fluids or other solid materials over time to achieve a concentration equilibrium. Hydrogen should be stored in materials that minimise permeation and reduce the associated losses.

Certain metallic materials and equipment that are exposed to hydrogen gas can suffer from hydrogen embrittlement. These can include material used for the interior surfaces of tanks, weldments, pipes, valves, fuel nozzles and pressure-relief valves or pipes. Hydrogen embrittlement occurs when it is absorbed by a metal and collects at the boundaries of the grain, creating weak spots within the material, as shown in Figure 5.

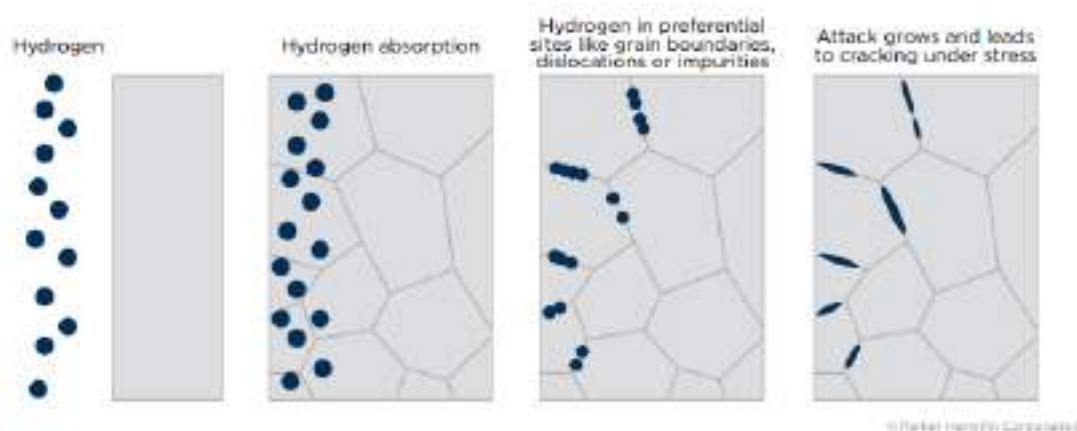

Figure 5. Illustration of hydrogen embrittlement (ABS, Sustainability Whitepaper, Hydrogen as Marine Fuel, 2021)

Hydrogen absorption can lead to brittle-failure mechanics, microscopic fractures, material cracks and leakage. Factors that influence hydrogen embrittlement in metals include the material stress levels, stress or strain rates, the pressure of its containment, temperature, purity, types of impurities, material composition, tensile strength, grain size,

material microstructure and the material's heat-treatment history. If left dormant, hydrogen can eventually permeate through the material and escape.

Embrittlement can be avoided by using the proper metallic materials with appropriate thicknesses and by applying surface treatments and coatings/films to protect from hydrogen contact. Care should be taken during metal forming to ensure that hydrogen atoms escape during heat treatment and that welding practices try to avoid the formation of hard microstructures Figure 5.

Another material concern is 'high temperature hydrogen attack'. Low-alloyed structural steel has been known to degrade from the hydrogen attacks that occur at temperatures above 200°C (392°F), where carbon reacts with hydrogen to create methane and cause material embrittlement. Hydrogen attacks may not be common for tanks and pipes unless they are exposed to high temperatures, such as those experienced in combustion engines, fuel decomposers (reformers) and fuel cells. Metal and non-metal materials shown in Table 11 are listed to describe the acceptability of use for gaseous and liquid hydrogen applications.

Table 11. Materials Compatible with Hydrogen

Material	HYDROGEN PHASE		NOTES
	Gas	Liquid	
Aluminum and aluminum alloys	Acceptable	Acceptable	N/A
Austenitic stainless steels with > 7% nickel (e.g., 304, 304L, 308, 316, 321, 347)	Acceptable	Acceptable	Beware of martensitic conversion at low temperature if stressed above yield point
Carbon steels	Acceptable <sup>1</sup>	Not acceptable	Too brittle for cryogenic service
Copper and copper alloys (e.g., brass, bronze, and copper-nickel)	Acceptable	Acceptable	N/A
Gray, ductile or cast iron	Not Acceptable	Not Acceptable	Not for hydrogen service
Low-alloy steels	Acceptable <sup>1</sup>	Not Acceptable	Too brittle for cryogenic service
Nickel and nickel alloys (e.g., Inconel and Monel)	Acceptable <sup>1</sup>	Not Acceptable	Susceptible to hydrogen embrittlement <sup>2</sup>
Nickel steels (e.g., 2.25%, 3.5%, 5%, and 9% Ni)	Not Acceptable	Not Acceptable	Beware of ductility loss
Titanium and titanium alloys	Not Acceptable	Acceptable	Beware of susceptibility to hydrogen embrittlement
Chloroprene rubber (neoprene)	Acceptable	Not Acceptable	Too brittle for cryogenic service
Dacron™(or equivalent)	Acceptable	Not Acceptable	Too brittle for cryogenic service
Fluorocarbon rubber (Viton™ or equivalent)	Acceptable	Not Acceptable	Too brittle for cryogenic service
Mylar (or equivalent)	Acceptable	Not Acceptable	Too brittle for cryogenic service
Nitrile (buna-n)	Acceptable	Not Acceptable	Too brittle for cryogenic service
Polyamides (nylon)	Acceptable	Not Acceptable	Too brittle for cryogenic service
Polychlorotrifluoroethylene (PCTFE)	Acceptable	Acceptable	N/A
Polytetrafluoroethylene (Teflon™ or equivalent)	Acceptable	Acceptable	N/A

Source: ANSI/AIAA G-095A

Notes:

<sup>1</sup> When applicable, procedures specified by ASTM B849 and SAE USCAR-5 should be applied to reduce risks of hydrogen embrittlement.

<sup>2</sup> Hydrogen embrittlement is not an issue at cryogenic temperatures

In this light, significant technical advances appear to be needed for hydrogen to become a viable, large-scale, commercial fuel option, particularly for applications with large volumes of hydrogen fuel that may require increased space onboard a ship, such as those for longer routes and deep-sea voyages.

Hydrogen stored as cargo can be kept in its densest cryogenic liquid form to increase trading volume and storage onboard. However, larger fuel volumes and storage arrangements for gaseous and liquefied hydrogen onboard may require a trade-off between cargo space -- depending on the density of the hydrogen -- vessel operations, onboard power systems and routes. Hydrogen-fuelled vessels traveling close to or operating near bunkering facilities, with the opportunity to bunker often, may experience minimal problems with fuel reduction or the loss of cargo space.

For liquefied hydrogen at low pressures, the energy loss during storage and the generation of boil-off gas may be a challenge for long-term storage applications, depending on the pressure rating of the cryogenic tank and the length of time it is left dormant. The boil-off rate is 1-5% per day for standard land-based liquid hydrogen storage tanks.

Improved insulation and higher storage costs can reduce the daily liquid hydrogen boil off to 0.02% of volume. To avoid losses, the boil-off gas from liquefied gas tanks can be consumed in an engine or fuel cell, as practiced onboard ships equipped with LNG tanks.

Tanks containing pressurised gaseous hydrogen do not experience issues with boil-off gas. However, the volume/capacity of the pressure vessels is an issue. The storage vessels available today and used in the first hydrogen-fuelled tugs take up about 14 times the volume compared to those used for fuel oil. This is a major obstacle for the use of hydrogen as a marine fuel. Additionally, the lowest supply pressure required for hydrogen engines is 3-5 bar. For bigger tank systems, this creates the need for a bottle emptier (compressor) to empty them and to improve the volume efficiency. For smaller ship sizes the bottle emptier will likely be omitted due to the cost of the compressor as it will be cheaper to leave a pressure of 3-5 bar in the tank system instead of fully emptying the tanks by using a bottle emptier.

Cooling hydrogen to  $-253^{\circ}\text{C}$  requires a significant amount of energy. Roughly one third of the energy stored is used for the cooling and storage of hydrogen. Since pressurisation takes up about 14 times the volume, efforts are being made to use a combination of the two dominant storage options. This can be achieved by cryo-compressed storage, which uses a combination of cooling and pressurisation of the hydrogen, optimizing the cost and volume for the storage.

Besides storing hydrogen directly in gaseous or liquefied forms, other forms, such as 'slushed' hydrogen, are being made available due to their potential for higher volume efficiency. Hydrogen slush is a supercooled form of hydrogen that has a slush-like consistency. It is produced by cooling hydrogen gas to around  $-253^{\circ}\text{C}$ , at which point it turns into a liquid. The liquid hydrogen is then further cooled to around  $-259^{\circ}\text{C}$ , turning it into a slushy mixture of liquid and solid particles. This process is achieved by using a 'cryocooler', a device that generates very low temperatures.

The advantage of producing hydrogen slush is that it allows for more efficient storage and transportation. Hydrogen slush has a higher density than regular liquid hydrogen, which means that more hydrogen can be stored in a specific volume. However, industry has yet to see this solution used for bigger applications.

## 2.4.2 Material-Based Storage Options

As analysed earlier, the costs for the storage and transportation of hydrogen in its physical conditions is rather high. For this reason, a lot of effort has been made to develop materials-based storage options that could potentially offer some cost reduction, such as Liquid Organic Hydrogen Carriers (LOHC) and ammonia.

LOHC seems to be the most promising technology among the materials-based options. LOHC are chemical compounds, such as toluene or methylcyclohexane, which can absorb or release hydrogen via chemical reactions. When absorbing hydrogen, LOHC can be used for hydrogen storage at ambient conditions. This process enables easy and safe storage and transportation of hydrogen since it can be handled just like oil, using the existing infrastructure. This also allows the hydrogen to be loaded and shipped onto conventional crude oil tankers.

The flow of the process is described in (Figure 6) and can be explained as follows: After the hydrogen has been produced, it is sent to the storage plant. It is then bonded to the LOHC molecules (creating LOHC<sup>+</sup>), allowing for

storage at ambient conditions and transport with an oil tanker. At the delivery hub, the LOHC<sup>+</sup> is unloaded for dehydrogenation, i.e., removal of hydrogen. Subsequently, the oil tanker is refilled with LOHC<sup>-</sup>, which has been depleted of hydrogen, and returns to exchange the LOHC<sup>-</sup> and collect more LOHC<sup>+</sup>.



Figure 6. Example showing the process flow of the LOHC value chain by Hydrogenious LOHC Technologies. A plus refers to bonded hydrogen, a minus refers to hydrogen that is not bonded in the LOHC molecules.

However, it should be noted that the energy used for the dehydrogenation process is significant. This means that on longer routes, the LOHC storage option seems to be more economically feasible than liquid hydrogen transportation. Therefore, identifying the routes where it makes sense to introduce LOHC needs to be carefully investigated. Another point that needs further analysis is the need to replace the chemicals due to degeneration, leading to an additional cost.

As an alternative, ammonia can also be used as a hydrogen carrier. This has the benefit of using the existing infrastructure for global distribution. Additionally, the technology used to convert hydrogen to ammonia is well established. In cases where the end use is ammonia or where ammonia can be used instead of hydrogen in fuel-combustion engines, shipping ammonia seems to be the preferred option. (Path to hydrogen competitiveness. A cost perspective, 2020)

Metal hybrids and sorbents are other options for material-based storage. However, these will not be analysed in this study since they are on an early stage of development.

### 2.4.3 Onboard Fuel Supply

The purpose of the fuel supply system (FSS) or fuel gas supply system (FGSS) is to deliver the fuel at the correct temperature and pressure to its consumer, a fuel cell or internal combustion engine. The use of low-flashpoint fuels and gases further complicates the fuel supply and consumer systems and creates a greater interdependence between the key systems than for conventional fuel systems.

The key elements of the onboard hydrogen installation are the fuel-storage tank, the fuel supply system and the safety-valve system, commonly known as gas valve unit (GVU) or gas valve train (GVT). For liquid fuels this is called fuel valve train (FVT). The fuel supply system needs to be integrated with the tank systems - see Figure 7 and Figure 8 below for a Diesel cycle engine system and an Otto cycle engine system. Figure 8 is illustrating a fuel supply system for a smaller ship installation which is not equipped with a bottle emptier, i.e., the tanks are not fully empty before being refilled.

For hydrogen, the FGSS needs to be designed very differently, depending on whether it is stored in liquid or gas form. In a liquid-storage system, the hydrogen will be pressurised in the cryogenic and liquid state; thereafter the temperature will be controlled. Both pressure and temperature will need to be controlled according to the requirement of the consumer (see example in Figure 7).

The pressurisation of a liquid is more efficient than the compression of a gas. Thus, a compressor is only added if there is BOG (boil-off gas) that needs to be handled. The system to deal with the BOG can be a reliquefaction system designed fully independent or it can be integrated into the FGSS.

For cryogenic and liquid hydrogen, a pressure-relief system that sends the hydrogen to a vent system should be applied; it is important for the valves to be protected against the formation of water (or other liquefied atmospheric gases) or the build-up of ice (solids) due to very low temperatures.

In general, designing the FGSS of these types has been proved challenging as the risk of ice formation in valves and other operationally critical equipment is high; furthermore, keeping the system gas tight due to thermal expansions and avoiding the build-up of vapours due to excessive heat-loss from piping, valve and pumps, etc., is extra challenging when dealing with temperatures near -253°C.

For the pressurised storage system, it is a bit simpler to design the FGSS. The issue is the storage volume, as explained in subsection 2.4.1, so a bottle emptier (compressor) may be needed for bigger tank systems to empty them and improve the volume efficiency. Generally, the supply pressure going to the consumer can be controlled using a pressure-control valve. Again, the system needs to be equipped with a pressure-relief component that sends the hydrogen to a vent system. When hydrogen expands, it does not cool like methane and the risk for building up ice around the valves is limited.

The required supply pressures for designing the FGSS in available marine engines are summarised in Table 12. Other energy-related aspects of the alternative fuels and the corresponding sizes of the fuel tanks with known supply condition are also shown.

Table 12. Key properties, required storage capacity and supply conditions of alternative fuels

FUEL	Fuel Properties							Storage Fuel Tank Volume Compared to MGO (not including insulation and secondary barriers, as applicable)	FGSS/FSS Supply Pressure (bar)
	Storage Conditions (liquid state)		Specific Energy (MJ/kg)	Energy Density (MJ/L)	Carbon Content	C <sub>F</sub> (t-CO <sub>2</sub> /t- Fuel)	kg CO <sub>2</sub> /kW h		
	Temperature	Pressure							
<b>MGO</b>	atm	atm	42.7	38.4	0.8744	3.206	0.2701	1	8
<b>LNG</b>	-162C	atm (or pressurised ~5-10 bar)	48	21.6	0.75	2.75	0.2061	1.8	300 (Diesel)
									5 ~ 13(Otto)
<b>Ethane</b>	-89C	atm (or semi-ref ~ 5 bar)	47.8	27.2	0.7989	2.927	0.2205	1.4	380 (Diesel) ~ 5 (Otto)
<b>Methanol</b>	atm	atm	19.9	15.7	0.375	1.375	0.2486	2.4	10
<b>LPG</b>	-48C (Propane)	atm (or fully pressurised up to 18 bar)	46.3 (Propane)	23.2	0.8182	3.00	0.2331	1.7	50
			45.7 (Butane)	27.4	0.8264	3.03	0.2385		
<b>Ammonia</b>	-33C	atm (or fully pressurised up to~ 18 bar)	18.6	12.9	0.0*	0.0*	0.0*	3.0	83
<b>Hydrogen</b>	-253C	atm (or pressurised ~100-300 bar)	120.0	8.5	0.0*	0.0*	0.0*	Liquid > 4.5	3-10 bar (Otto)
								Pressure (25- 700 bar) > 8	

\* Carbon contained in the pilot fuel needs to be considered. This means that the final figure will be bigger than zero.

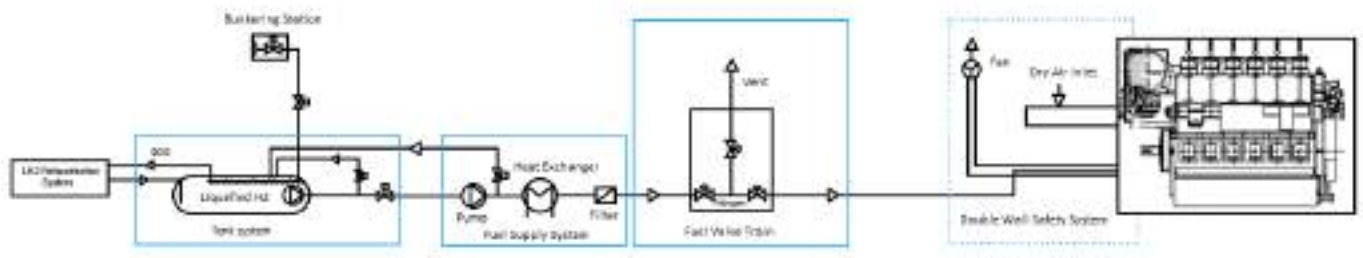

Figure 7. Schematic onboard hydrogen installation of the FSS for a 2-stroke Diesel-cycle hydrogen engine

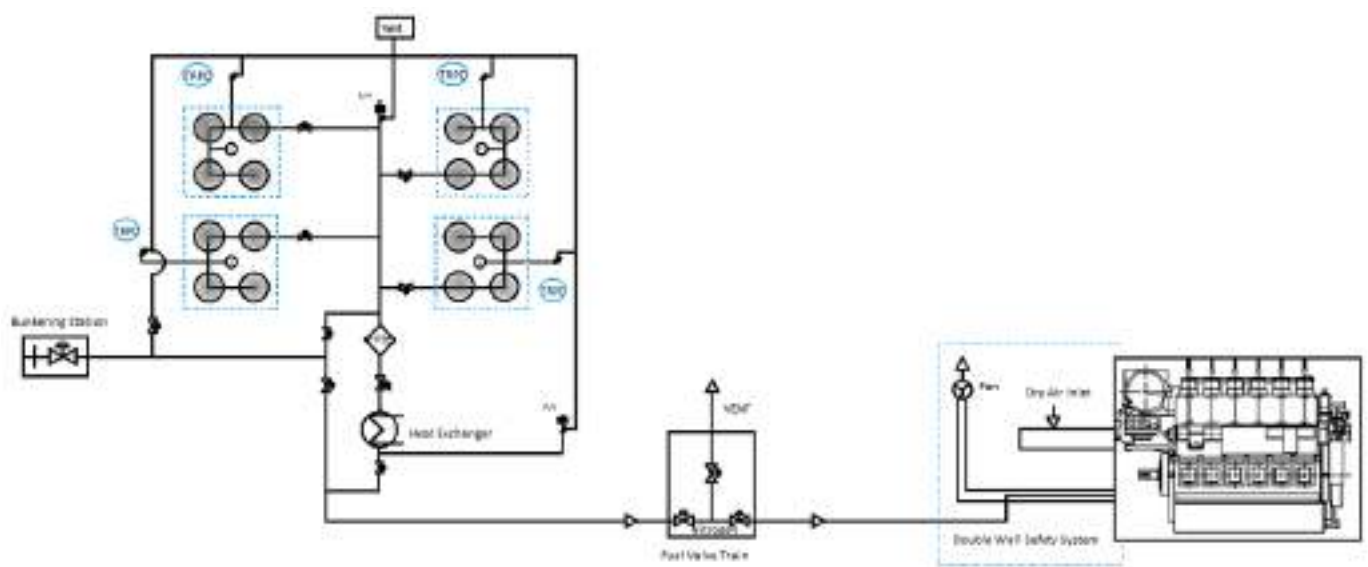

Figure 8. Schematic integration of the FSS for a 4-stroke Otto-cycle hydrogen engine

#### 2.4.4 Internal Combustion Engines

Burning the gaseous fuel hydrogen in an internal combustion engine for marine applications is expected to follow the combustion pathway of the dual-fuel (DF) methane engines. Methane has been used as a fuel on LNG carriers for more than 60 years, originally in gas boilers for steam-turbine propulsion. From around 2005, it was used in 4-stroke internal combustion engines in a dual-fuel diesel electric (DFDE) propulsion arrangement; also, in 2015, the twin skeg, 2-stroke, slow speed, DF-direct drive propulsion layout entered the market; this is now the dominant propulsion choice, primarily due to the higher efficiencies it offers.

At the time of publication, there were approximately 900 LNG-fuelled ships on order or in service; the existing LNG-fuelled fleet has supported the development of DF-engine technologies for other low-flashpoint fuels and gases and the regulatory framework for adopting the alternative fuels.

The first 2-stroke slow speed dual fuel engines orders for the non-gas carrier fleet were the MAN ME-GI engines for the U.S. flagged *Isla Bella* for Tote Maritime, a 3,100-TEU containership that entered service in early 2016. This engine design uses a high-pressure gas injection of approximately 300 bar. It also uses the Diesel combustion cycle in gas mode, rather than the Otto cycle used in the 4-stroke engines and the competitor 2-stroke X-DF engine from Winterthur Gas & Diesel (WinGD).

## Combustion cycles

The choice of the combustion cycle is very important for the engine and fuel supply system designs, performance, emissions and the overall cost of the system. The two concepts are low-pressure (LP) gas engines using the Otto cycle and high-pressure (HP) gas engines using the Diesel cycle.

The LP DF engines use the Otto cycle in gas mode and the conventional Diesel cycle in fuel oil mode. The HP DF engines use the Diesel cycle for fuel oil and gas modes. For both concepts, the gas is ignited by a pilot injection of liquid fuel (e.g., MGO) from the conventional fuel-injection system or a dedicated pilot system. The point during the combustion cycle where the gas is injected dictates the supply pressure that is required for the gas.

The dual fuel 4-stroke engines operating on hydrogen, which have been recently put in operation, use the Otto cycle with gas-supply pressures of approximately 5 bar through gas admission valves, and the pressure is always at least one bar higher than the scavenge air pressure.

The Otto cycle engine burns the fuel in pre-mixed combustion. These engines are characterised by longer time to reach the demanded power output because the air/fuel ratio will have to be controlled to avoid knocking or misfires. It should be noted, however, that when pure hydrogen is used in an engine, its higher heat-release capacity and wider flammability limits could lead to high thermal loads. The higher peak temperatures may also result in increased NO<sub>x</sub> emissions. The higher thermal load on the combustion-chamber component and lubrication oil are considered to be the key challenges in designing those engines.

Table 13. Comparison between Low-Pressure and High-Pressure DF engines

	Low-Pressure (LP)		High-Pressure (HP)	
Gas mode cycle type	Otto		Diesel	
Gas injection / Combustion principles- methane and hydrogen	LP gas-admission valves located on the cylinder for pre-mixed gas/air and in-cylinder compression (diesel pilot fuel required for start of combustion)		HP gas-injection valves located on the cylinder cover for direct gas injection into the cylinder for diffusion combustion (diesel pilot fuel required for start of combustion)	
Fuel	Methane gas	Hydrogen (guid. values)	Methane	Hydrogen (guid. values)
Fuel-supply pressure	~5 bar (4-stroke) <13-16 bar (2-stroke)	3-16 bar	300 bar	~300 bar
Injection pressure	Same as supply pressure	Same as supply pressure	Same as supply pressure	Same as supply pressure
Liquid pilot % @MCR	0.5 – 1.0	0.5 – 15%	0.5 – 1.5	0.5-5
BMEP [bar]	17.3	~17	21.0	21.0
Min load for DF mode [%]	~5	~5	~5	~5
IMO NO <sub>x</sub> Compliance	Tier II (oil mode) Tier III (gas mode)	Tier II (oil mode) Tier II (hydrogen mode)	Tier II (oil mode) Tier II (gas mode)	Tier II (oil mode) Tier II (hydrogen mode)
Fuel Quality Sensitive	Yes - Requirement for Methane Number	Yes	No	No
Fuel Slip	Yes	Insignificant	Insignificant	Insignificant
Knock/Misfire Sensitive	Yes	Yes, however the risk of misfire is low	No	No
Load response	reduced	reduced	unchanged	unchanged



As indicated by the table above, the Otto combustion cycle has some limitations in terms of maximum Brake Mean Effective Pressure (BMEP) and is susceptible to gas quality, i.e., the methane number (MN), which is an indicator of combustion derived from the composition of the natural gas. Furthermore, the Otto cycle-process is subject to significant methane slip, which is the unburnt fuel released to the atmosphere, adding to GHG emissions. It should also be noted that hydrogen has a higher reactivity and flame speed which will reduce the potential for misfires and can potentially result in reduced emissions from fuel slips, so hydrogen fuel slip from the combustion is not foreseen to be a potential GHG issue considering that hydrogen if releases will have indirect GHG impact. A high auto-ignition temperature makes it possible to design the engine with higher compression ratios than LNG-fuelled engines of the same type.

It should be noted that the BMEP limitations of the Otto cycle for the combustion of methane natural gas have been feasible by reducing the BMEP with a derating (i.e., reduced engine power output) of the engine. However, for most of the other gaseous and low-flashpoint fuels that are coming into the market, such as methanol, LPG, hydrogen and ammonia, the derating approach might not always be the right way forward (due to increased cost per kW, space, engine performance, fuel slip etc.).

On the other hand, for the combustion of hydrogen, the option is to use either the Diesel cycle combustion principles or the Otto cycle combustion principle. The benefit of the diesel cycle is that it gives better fuel flexibility, avoidance of knocking and the same maximum engine output can be maintained. However, in Diesel cycle, there is a need to generate a high injection pressure for hydrogen which will increase the cost of the fuel supply system even more than for this used for LNG the dual-fuel engines. Generating such high-pressure gas can be done either by using high-pressure hydrogen compressors or cryogenic pump equipment designed for  $-253^{\circ}\text{C}$ ; both types of equipment are costly (see Figure 7). No HP diesel-cycle engine operating on Hydrogen has yet been designed for the marine industry. The cost of the fuel supply system is therefore not yet known, but it is expected that this is of a magnitude of 5-10 times the cost of an FGS system designed for the LP Otto-cycle engines. Therefore, for hydrogen, it is expected that the Otto cycle engines principles will dominate the future.

## **References**

For existing marine engines, both combustion concepts have been selected for methane. There are some examples of the Otto cycle engines being used to burn ethane or LPG. However, these solutions come with a significant engine derating due to its combustion limitations with fuel slip, knock and misfire. The Diesel cycle has been applied for burning methanol by MAN and Wärtsilä; MAN also has used the Diesel cycle for ethane and LPG.

For fuels that can be maintained in a liquid state in the engine, MAN has developed the dual fuel Liquid Gas Injection technology 'ME-LGI' to move away from gaseous HP injection; the engine is designed to inject HP liquid fuels through a dedicated injector with a built in booster that increases the liquid gas supply pressure to the injection pressure. This technology can be applied for methanol, LPG, dimethyl ether (DME) and other similarly nominal liquid fuels at ambient or low-pressure conditions, such as ammonia.

For the use of hydrogen, as Figure 9 shows the main engine, BeHydro<sup>®</sup>, is available today from ABC engines. This engine series, named the DZ H<sub>2</sub>, covers a power range from 1-2.8MW and was launched in 2020. It uses the Otto cycle principles to combust hydrogen; a pilot oil amount of 15% is required to control the combustion. The main challenge is to secure stable combustion due to the elevated risk of knocking. So, the engine is equipped with knocking sensors and pressure-relief valves to handle any overpressure in the different compartments.



Figure 9. Main engine design for the ABC BeHydro<sup>®</sup> engine, the dual-fuel hydrogen 4-stroke engine; it is available with up to 16 cylinders and delivers 2.6MW.

Table 14 shows the main alternative fuel marine engine types and combustion cycles in service and under development, with the associated low-flashpoint fuels and gases they are designed to burn.

Table 14. Marine engines in service and under development, as per the different alternative fuels

Engine Type	Layout	Alternative Fuel	Combustion Cycle	Year of first engine delivery (*expected)
MAN B&W ME-GI	2-stroke, slow speed	Methane	Diesel	2014
WinGD X-DF	2-stroke, slow speed	Methane	Otto	2016
Wärtsilä DF	4-stroke, medium speed	Methane (Ethane, LPG)	Otto	1995 (Methane)
MAN	4-stroke, medium speed	Methane	Otto	2016
Wärtsilä GD (legacy engine)	4-stroke, medium speed	Gas-Diesel	Diesel	1987
Wärtsilä SG and LG (land based only)	4-stroke, medium speed	LPG	Otto (SG) Diesel (LG)	1996
MAN B&W ME-GIE	2-stroke, slow speed	Ethane	Diesel	2016
MAN B&W ME-LGIM	2-stroke, slow speed	Methanol	Diesel	2015
MAN B&W ME-LGIP	2-stroke, slow speed	LPG	Diesel	2020
Wärtsilä (conversion)	4-stroke, medium speed	Methanol	Diesel	2015

Engine Type	Layout	Alternative Fuel	Combustion Cycle	Year of first engine delivery (*expected)
Himsen	4-stroke, medium speed	Methanol	Diesel	2023
Himsen ( under development )	4-stroke, medium speed	Ammonia	Diesel/Otto	2024*
Himsen ( under development )	4-stroke, medium speed	Hydrogen	Otto	2026*
Kawasaki ( under development )	4-stroke, medium speed	Hydrogen	Otto	2027*
MAN B&W ME-LGIA (under development)	2-stroke, slow speed	Ammonia	Diesel	2024*
WinGD X-DF-A ( under development )	2-stroke, slow speed	Ammonia	Diesel	2025*
WinGD X-DF-M ( under development )	2-stroke, slow speed	Methanol	Diesel	2024*
Wärtsilä DF (under development)	4-stroke, medium speed	Ammonia	Otto	2023*
Wärtsilä LG (under development)	4-stroke medium speed	Ammonia	Diesel	2025*
Himsen (under development)	4-stroke, medium speed	Ammonia	Diesel	2024*
MAN-ES	4-stroke, medium speed	Ammonia	Diesel	2026*
MAN-ES ( under development )	4-stroke, medium speed	Methanol	Otto	2024*
ABC	4-stroke, medium speed	Hydrogen	Otto	2020
ABC ( under development )	4-stroke, medium speed	Methanol	Otto	2024*
Wärtsilä ( under developemnt )	4-stroke, medium speed	Hydrogen	Otto	2024*

## Research and Development

The primary markets for hydrogen-fuelled engines are expected to be offshore supply vessels and short-sea vessels. ABC Engines has selected to develop an engine based on the Otto cycle concept and it is anticipated that other engine manufacturers will follow the same combustion routes, due to the projected high cost of the fuel supply system supporting Diesel concepts.

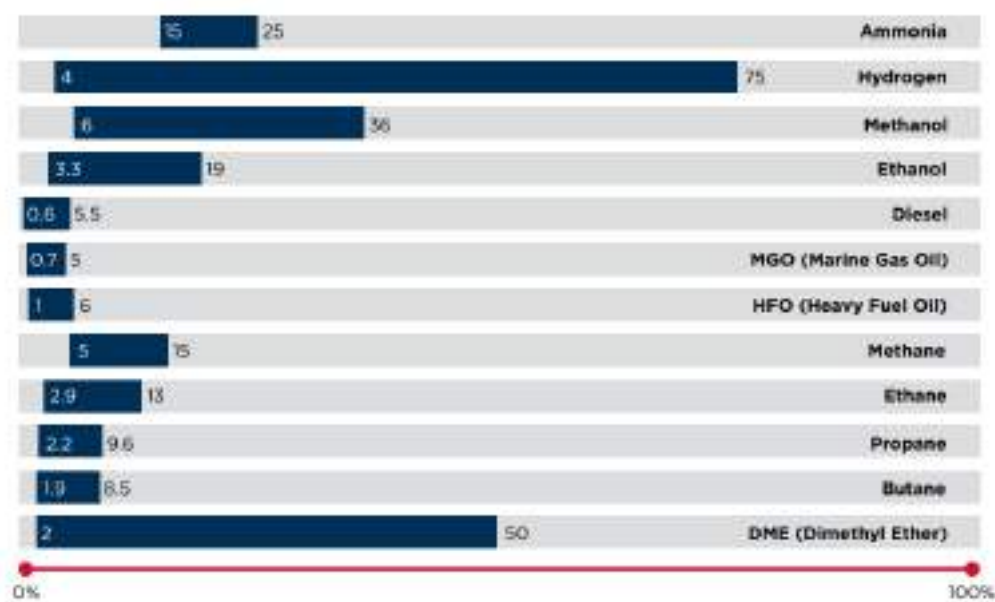

Figure 10. The flammability ranges for different fuels in % volume with air (ABS, Sustainability Whitepaper, Hydrogen as Marine Fuel, 2021)

Wärtsilä<sup>6</sup> is also offering an option for blending hydrogen with methane in some of its Otto (or Diesel) cycle engines burning natural gas as a way to reduce CO<sub>2</sub> emissions. Blending hydrogen with methane has been shown to benefit the combustion of the latter, since this can potentially improve the engine efficiency and reduce methane slip.

At the same time, there is an industry interest in pre-combustion carbon capture concepts that decompose (reform) methane into hydrogen and solid carbon that is stored onboard. If the carbon capture rate is less than 100%, then hydrogen is mixed into the methane. The process is called ‘thermo-catalytic decomposition’ (see subsection 2.4.5). The solution is expected to be particularly interesting for LNG carriers using LNG as fuel, on which reducing CO<sub>2</sub> emissions would require either a reliquefaction system combined with the use of renewable fuels or a carbon-capture system. With the decomposer solution solid carbon can be generated, instead of liquid CO<sub>2</sub>, which could be a source of revenue, since it has a significant market value (see also subsection 2.5.5 paragraph LNG carrier: Natural gas to hydrogen decomposition).

#### 2.4.5 Thermo-Catalytic Decomposition (TCD) process

In the TCD process, the methane molecule is cracked using heat energy and catalysts. The hydrogen is released in gas form and carbon is produced in solid form. The gas released is typically a blend of hydrogen (89%vol) and unreacted methane (11%vol) and is called decomposition gas. Utilizing decomposition gas as fuel in the engine, instead of LNG, reduces CO<sub>2</sub> emission since the carbon has been removed from the fuel before combustion (pre-combustion carbon capture).

The heat required for the TCD process can be produced by different methods, including:

- 1) combustion of a small side stream of the feedstock gas (vapourised LNG),
- 2) combustion of a small fraction of the produced hydrogen gas, or
- 3) heating with renewable electricity

Among the above options, the combustion of feedstock gas (vapourised LNG) is currently the most feasible and energy-efficient solution onboard marine vessels. In the future, with CO<sub>2</sub> emission limits becoming more stringent, it would be meaningful to start using part of the produced hydrogen for heating. This could lead to reducing the CO<sub>2</sub> emissions from the decomposition process to zero.

<sup>6</sup> Wärtsilä Presentation “Multi-Fuel Engines for Future Propulsion”, Frank Harteveld Motorship, Propulsion and Future Fuels Conference, Copenhagen, 2021

The catalyst forms a vital part of the process as it significantly lowers the temperature required making the process less energy consuming. A molten catalyst is used, which is derived from a metal alloy that is heated to the reaction temperature. The liquid metal has high heat capacity, ensuring a homogenous heat supply directly to each methane molecule. By flowing the natural-gas stream through the molten metal, the catalyst is not able to cool down (which would hinder the initiation of the reactions) and the decomposition reactor volume capacity can be fully exploited.

When methane molecules are split into hydrogen and carbon, the gaseous hydrogen continues its flow forward (upwards, in molten media) and escapes the liquid molten media. Normally, the remaining solid carbon (in a conventional dry-methane conversion process) would attach itself onto the surface of catalyst and eventually fully cover the surface area and block it from functioning as a catalyst. However, with the catalyst being a liquid metal, there is no surface for the carbon to attach to. The carbon particles remain as solid particles flowing in liquid metal. The density difference between molten metal and carbon particles makes the latter float upwards in the molten media. These characteristics allow the removal of both produced hydrogen gas and solid carbon during operation without significant catalyst losses.

During the decomposition, apart from methane, fractions of other unreacted substances in natural gas may also end up in the decomposition gas. Hydrocarbon byproducts may appear in decomposition gas in very low concentrations. Also, the fraction of nitrogen often seen in natural gas - and especially boil-off gas - does not seem to pose a problem. This ensures that when using natural boil-off gas as feedstock (instead of pure methane) it does not cause operational problems. At the same time, the conditions in the decomposition reactor are kept by a good margin away from conditions where, for example, NH<sub>3</sub> could form.

Today, this TCD solution has been developed only for natural gas. Nevertheless, in the longer-term, other hydrocarbons such as methanol and diesel could be decomposed and converted into hydrogen. This solution could pave the way for the development of large-bore hydrogen engines.

## 2.4.6 Fuel Cells

A fuel cell is a device that converts chemical energy from a fuel into electricity through an electrochemical reaction of the fuel with oxygen or another oxidising agent. Fuel cells differ from batteries given that they require a continuous source of fuel and oxygen (usually from air) to sustain the chemical reaction, whereas a battery's chemical energy is fixed by the amount of chemicals in the battery. Fuel cells can produce electricity continuously if fuel and oxygen are supplied. There are many types of designs for fuel cells. Most consist of an anode, cathode and an electrolyte that allows positively charged hydrogen ions to move from the anode to the cathode side of the fuel cell. Their main benefits are increased energy efficiency, low to no emissions and lower noise levels.

Fuel cells are generally classified by the type of electrolyte used in the electrochemical process. The main fuel cells available today include: Proton Exchange membrane (PEM), Alkaline Fuel Cells (AFC), Phosphoric Acid Fuel Cells (PAFC), Molten Carbonate Fuel Cells (MCFC) and Solid Oxide Fuel Cells (SOFC). See Table 15 for the operating temperatures and typical applications for these fuel cells. Refer to the EMSA '*Study on the Use of Fuel Cells in Shipping*' (Tronstad, Astrand, Haugom, & Langfeldt, 2017) for more information.

Table 15. Types of Fuel Cells and their Applications

Type	Operating Temperature	Electrical efficiency*	Applications
Proton Exchange Membrane (PEM)	30-120 °C	50-60%	Vehicles and mobile applications and lower power Combined Heat and Power (CHP) systems
Alkaline Fuel Cell (AFC)	100-250 °C	50-60%	Used in space vehicles
Phosphoric Acid Fuel Cell (PAFC)	150-220 °C	40%	Large numbers of 200 kW CHP systems in use
Molten Carbonate Fuel Cell (MCFC)	600-700 °C	50%	Suitable for medium to large scale systems
Solid Oxide Fuel Cell (SOFC)	650-1,000 °C	60%	Suitable for all sizes of systems

\*Source: (DNV GL, 2017)

The fuel cell uses hydrogen ions, typically produced continuously by converting a hydrocarbon fuel, such as methane or methanol, in a close-coupled fuel reformer to produce a hydrogen or hydrogen-rich fuel source. Fuel cells offer minimal hydrogen storage; they are for processing purposes only. While offering lower efficiencies, this limitation avoids the complication of having to use hydrogen storage and distribution systems.

As with all fuel cell and reformer applications, the specific technology will require monitoring for the leakage of unreacted gases from the fuel reforming or electrochemical processes. This may require further processing or catalysis controls for safety reasons or to meet any (yet to-be developed) regulatory limits. The concern with fuel cells is related to the unreacted or unreacted gases that remain in hydrogen. These chemicals can be flammable and combustible; the performance and efficiency of the fuel cell also can be heavily affected by these chemicals, which can buildup in the fuel cells or damage the membrane. In both cases, the lifetime of the fuel cell can be reduced.

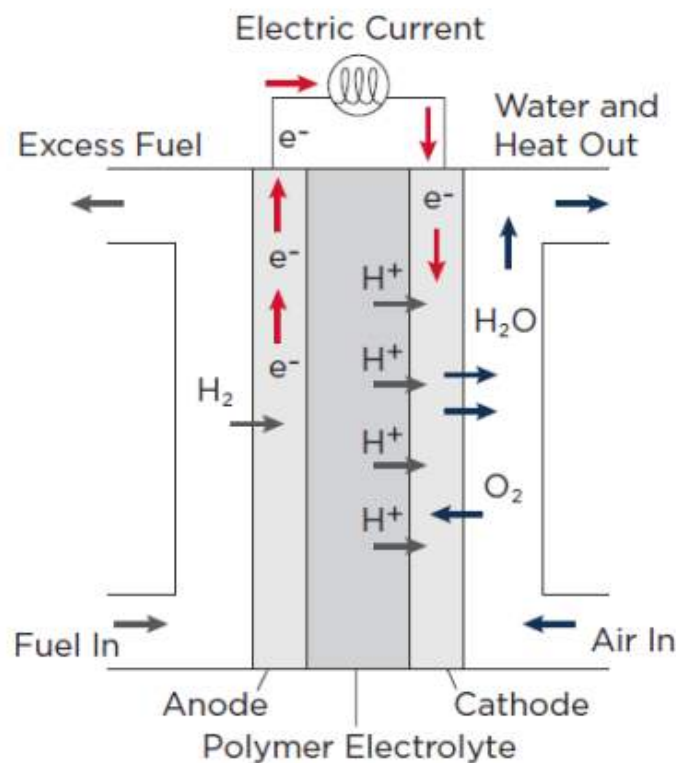

Figure 11. A typical Proton Exchange Membrane (PEM) Fuel Cell (ABS, Sustainability Whitepaper, Hydrogen as Marine Fuel, 2021)

### 2.4.7 Suitability Conclusions

While hydrogen is not used as a fuel by ocean-going ships, it is widely regarded as a potential fuel of the future for short-sea shipping. Reviews of its storage and distribution on land and combustion in internal combustion engine or use of fuel cells have not revealed insurmountable barriers.

For the time being, there are limited engine-makers that offer hydrogen-fuelled engines for marine use. ABC Engines launched their hydrogen version in 2020 and several other manufacturers, such as Wärtsilä, HHI-EMD and MAN-ES, had theirs under development at the time of writing. Due to their potential for emissions benefits, those with engines available have attracted a lot of interest. Nevertheless, only a few of the projects have materialised.

However, the storage of hydrogen is considered to be an obstacle. Compressed gas storage is the most common option to store hydrogen, suffering, however, from low storage density - even when high storage pressures are used. Also, as storage pressures increase, so does the associated cost of the materials and the safety risks. Higher pressures also introduce challenges associated with reliable compression, handling and additional piping, with multiple connections; the inherent regulatory restrictions also add cost. It is therefore difficult to see this storage solution being adopted soon on bigger ships.

This eventually could happen when large-bore engines become available for hydrogen operation. If ammonia could replace hydrogen in fuel cells or combustion engines, that would seem to be an interesting alternative. (Refer to the EMSA '*Potential of Ammonia as Fuel in Shipping*' (Laursen, et al., 2022)).

The storage of hydrogen seems to be a cost obstacle onboard bigger ships. However, it is noted that, when combusted, hydrogen offers low emissions and high combustion efficiencies because of its high heat release. The development of precombustion carbon-capture-solutions such as the TCD process rely on having hydrogen engines and fuel cells available and they do not need hydrogen storage. Even though the TRL of this technology is rather low (TRL 3-4), the initial test results are promising and this type of technology may pave the way for the development of 2-stroke/large-bore hydrogen engines. When hydrogen is stored in liquid form, the extreme cooling and storage processes are energy intensive and, in most cases, require a reliquefaction system to handle the boil of gas (BOG) and maintain the liquid condition of the hydrogen. The amount of BOG for this low temperature level (-253°C) can be significant corresponding to 1-5% per day and the power required for reliquefaction can be high. The equipment to handle the low cryogenic temperatures is costly. Therefore, both operating and capital-investment cost become a major challenge for storing liquid hydrogen.

Apart from hydrogen storage on board, hydrogen transportation as cargo has also been considered in this study. When transporting hydrogen over longer routes, both an LOHC and an ammonia-as-hydrogen carrier seem to be a more cost-efficient alternative. Despite the fact that onboard tanks have been applied to LOHC carriers, their design needs to be revisited and specifically customised for merchant ships. This eventually could happen when large-bore engines become available for hydrogen operation. If ammonia could replace hydrogen in fuel cells or combustion engines, that would seem to be an interesting alternative. (Refer to the EMSA '*Potential of Ammonia as Fuel in Shipping*' (Laursen, et al., 2022)).

The storage of hydrogen seems to be a cost obstacle onboard bigger ships. However, it is noted that, when combusted, hydrogen offers low emissions and high combustion efficiencies because of its high heat release. The development of precombustion carbon-capture-solutions such as the TCD process rely on having hydrogen engines and fuel cells available and they do not need hydrogen storage. Even though the TRL of this technology is rather low (TRL 3-4), the initial test results are promising and this type of technology may pave the way for the development of 2-stroke/large-bore hydrogen engines.

## 2.5 Cost Developments and Techno-Economic Analysis

To provide an overview of the cost development of hydrogen-propulsion systems in vessels, a techno-economic analysis has been performed with an outlook for the coming decades. The analysis shows the development of the total cost of ownership (TCO) for hydrogen-propulsion systems across several vessel types compared to their fossil-fuelled counterparts. The cost dimension of hydrogen applications in the marine sector is a major obstacle to overcome, since the technology is immature and not yet available at a competitive price compared to conventional fuel-oil systems.

### 2.5.1 General Considerations

This analysis presents an estimation of the TCO for hydrogen-powered vessels. It represents the total cost to the shipowner<sup>7</sup> assuming that liquid hydrogen bunker facilities were available at major ports. The cost for developing the supporting infrastructure is not included in the analysis either. These are considered major items to overcome.

The TCO is the sum of the yearly capital expenditures (CAPEX), annual fuel costs and other annual operational expenditures (OPEX). It is calculated for the ship types and size categories defined in the Fourth IMO Greenhouse Gas Study 2020 (Faber, et al., 2020) for the years 2030 and 2050. The specifications of all the cost elements under consideration are outlined in the forthcoming sections.

The CAPEX represents the investment costs for the propulsion and auxiliary systems, which are fixed and independent of the operation of the vessel. The OPEX is dependent on the frequency and intensity of the use of the

---

<sup>7</sup> While some cost components may in practice be passed on to the charterer (e.g. fuel cost, carbon cost), the aim here is to present a complete overview of all cost components for the acquisition and operation of hydrogen powered vessels.

vessel. The assumptions and input for the TCO model calculations are outlined in Appendix V – Additional Details of the TCO Modelling for Hydrogen-Fuelled ships.

The analysis considers hydrogen from two production sources, ‘green’ and ‘blue’ (liquefied) hydrogen. Green hydrogen is produced by an electrolysis process using green electricity (i.e., electricity produced by solar or wind power). Blue hydrogen is produced from steam-reformed natural gas and the CO<sub>2</sub> emissions from the process are captured and permanently stored, geologically. It is considered that hydrogen will be liquefied for storage and use onboard, as elaborated on in the following paragraphs.

In subsections 2.5.4 and 2.5.5, the outcomes of the TCO analysis are presented for relatively small ships. This is due to the following considerations:

As explained earlier, hydrogen used onboard ships can be stored in two different ways (see subsection 2.4.1); it can be compressed and stored as gas, or it can be stored as liquid hydrogen by means of cryo-compressed/cryogenic storage. Liquefied hydrogen has the advantage that the volumetric energy density (MJ per unit of volume) is higher compared to gaseous hydrogen, even if the gas is compressed. This is the reason for focusing on liquid hydrogen storage in the following analysis. Compared to liquid conventional bunker fuels, however, even liquid hydrogen has a much lower volumetric energy density (7.55 MJ/litre vs. 38.3 MJ/litre).

The cryogenic storage of liquid hydrogen requires relatively large tanks. Without compression, hydrogen liquifies at a temperature of -253°C, which is why cryogenic hydrogen tanks need to be very well insulated to prevent boil off/regasification. LNG is also stored in cryogenic tanks onboard ships, but the thermal-insulation layer for hydrogen tanks needs to be two to three times thicker than for Type C LNG tanks. Vacuum insulated tanks ensure a low boil-off rate. However, they are a more expensive option for large tanks.

When contained, the volumetric energy density of liquid hydrogen -- i.e., the volumetric energy density factoring in the volume of the tanks -- is obviously lower (4.6 MJ/litre contained vs. 7.55 MJ/litre uncontained). Compared to HFO (35.5 MJ/litre), the contained volumetric energy density of liquid hydrogen is 87% lower, which means that a ship could, theoretically, only carry about 13% of the energy if the same storage space was allocated for liquid hydrogen instead of HFO.

Table 16. Uncontained and contained volumetric energy density for HFO, liquid hydrogen and compressed gaseous H<sub>2</sub>

	Uncontained volumetric energy density (MJ/litre)*	Contained volumetric energy density (MJ/litre)
Diesel (HFO)	38.30	35.50
Liquid hydrogen (LH <sub>2</sub> )	7.55	4.60
Compressed gaseous hydrogen (700 bar)	4.68	3.46
Compressed gaseous hydrogen (300 bar)	2.6	1.4 – 2.0

Source: Marin (2023)

Therefore, ships that sail long distances would either have to refuel during a voyage or would have to sacrifice extra space to accommodate larger tanks. This requirement would be associated with a loss of profits, if the placement of larger/additional tanks came at the cost of the ship’s cargo-carrying capacity.

CE Delft & Ecorys (2021) specify the maximum distance bulk carriers, container ships and oil tankers can sail, depending on the vessel size, with a full tank of conventional liquid bunker fuel. Considering 13% of this maximum distance, it can be concluded that large container vessels would not be able to travel between Europe and China, for example, without refuelling liquid hydrogen. Large oil tankers would, without refuelling liquid hydrogen, theoretically only be able to cover the distance from south European ports to the Middle East. This is not the case from northern European ports to the Middle East.



Moreover, since the hydrogen tanks are more compact and less flexible in terms of space-utilisation than HFO tanks (and fuel margins also would be an issue), it is concluded that, given the current storage options, hydrogen as a shipping fuel is mainly suitable for ships operating on short to medium distances.

This is also confirmed by Marin (2023) in Figure 12, which illustrates that, considering the contained energy for similar volume/weight of fuel stored, liquefied hydrogen is only suitable for relatively short ranges, especially when compared to conventional liquid bunker fuels.

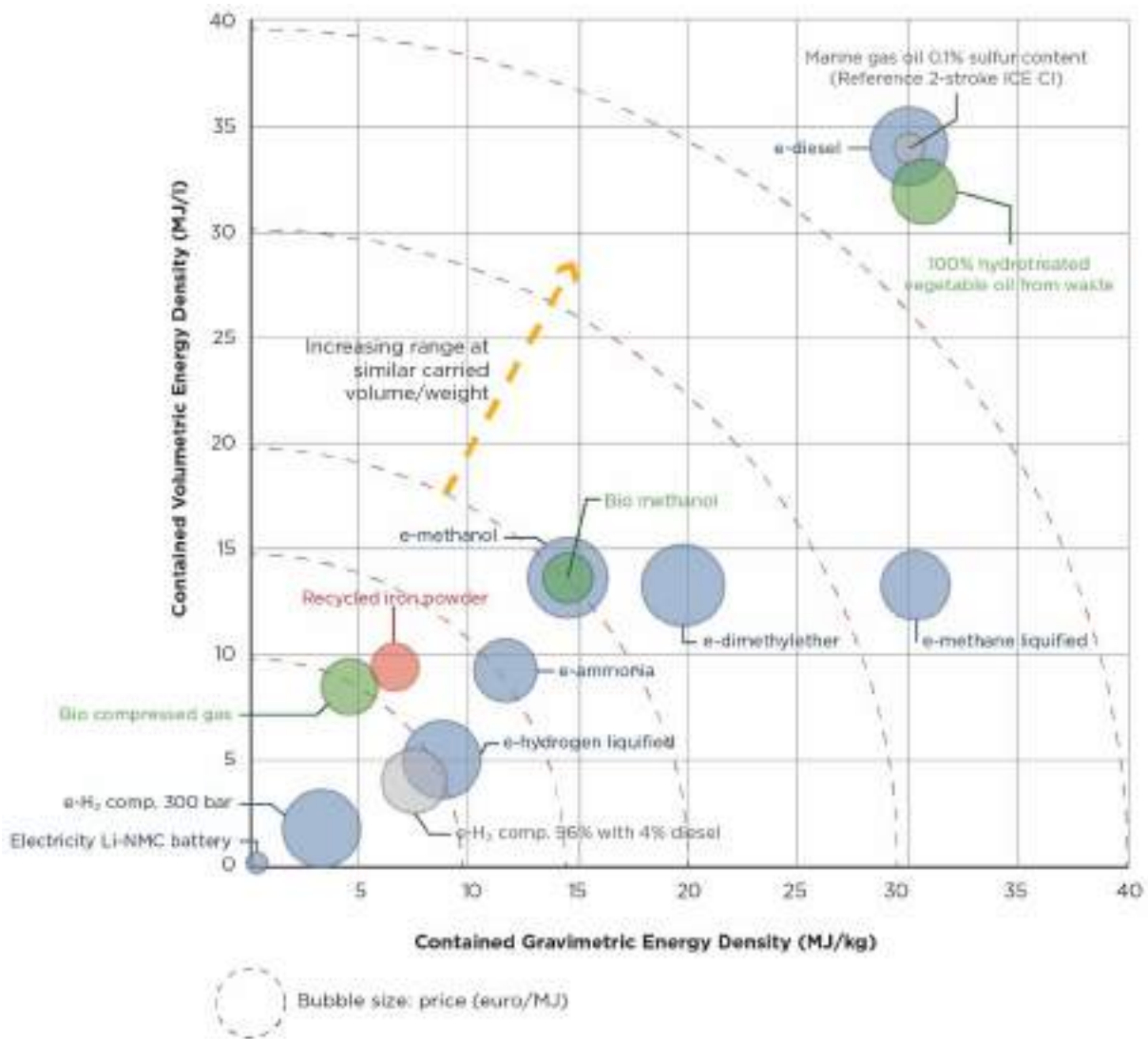

Figure 12. Energy Density of Sustainable Alternative Energy Carriers and Price per Energy Unit

### 2.5.2 CAPEX

The CAPEX are the fixed costs for the propulsion system on a newly built vessel and include the cost of the engine, after-treatment, storage (tanks) and the fuel supply system (FSS). In the analysis, only the fixed-cost items that are different (than conventionally fuelled ships) by design for hydrogen have been considered. The cost of the ship's hull

structure is not considered since it is assumed that the cost for the raw structure of a ship is similar irrespective of which fuel is used for propulsion<sup>8</sup>.

**Propulsion system cost**

The propulsion system is the main item in which a hydrogen-powered vessel differs from a conventional fuel oil-powered vessel. Two types of propulsion systems have been considered for their suitability as analysed in the preceding section: a dual-fuel internal combustion engine suitable for the combustion of hydrogen and a fuel cell system, combined with an electric motor to convert power into a rotating power for propulsion. For the latter, a battery pack is needed to provide additional power during peak demand operations, for example, during manoeuvring at port. As a reference, the internal combustion engine for combustion of fuel oil is considered.

The cost of the engine system depends on the ship’s required power capacity (in kW). The average installed power by ship type and size from the IMO fleet database (Faber, et al., 2020) was used to define the power capacity for the vessels. The engine CAPEX is expressed as a yearly cost over a lifetime of 25 years with a weighted average cost of capital of 7%. This is a representative value taken from figures used by shipping companies in several segments of shipping<sup>9</sup>.

Internal Combustion Engine (ICE) propulsion systems

In Figure 13, the cost per kW of installed power is presented for both fuel-oil (representing the reference) and a hydrogen-suitable internal combustion engine based on (ABC, 2022). The costs per kW differ between relatively high-powered engines (bar excluding shaded area) and relatively low-powered engines (upper end of bars, including shaded area), with the costs per kW being higher for the relatively low-powered engines. The lifetime of the fuel-oil system is 25 years and no cost decrease for this mature technology is assumed in the upcoming decades.

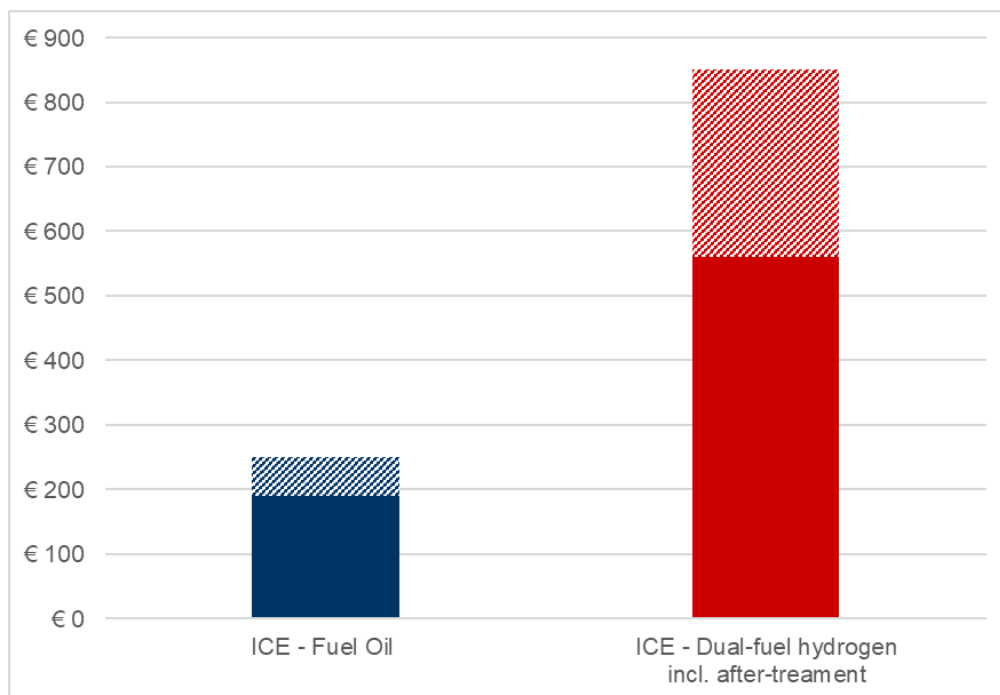

Figure 13. Cost range of fuel oil and hydrogen ICE systems per kW

It is observed that there is a significant cost gap between the fuel oil-engine system and the hydrogen dual-fuel engine system, as the latter is not yet an established technology produced on a large scale. For vessels having a larger engine system installed, the cost per kW will decrease in line with the economies of scale. Even for the largest

<sup>8</sup> It is noted that in practice it may be needed to adjust ship design to fit alternative fuel storage and other system components to fit in the vessel. These cases are out of scope in this analysis.

<sup>9</sup> The reported ranges of the WACC by several maritime freight operators ([Hapag-Lloyd](#) 7.7%-10.1%; [Yang Ming Marine Transport](#) 6.4%-8.3%; [Moller-Maersk](#) 7.8%, [Scorpio Tankers](#) 5.2%, [Western Bulk Chartering](#) 7.2%, [Eagle Bulk Shipping](#) 7.4%).

of dual-fuel hydrogen internal combustion engine systems, the current cost per kW is still more than double that of the fuel oil variant.

A 10% cost decrease for hydrogen dual-fuel engines in 2030 and 20% cost decrease in 2050 is assumed, compared to the 2022 levels. An average engine power efficiency of 40% for internal combustion engine propulsion output in coastal vessels has been assumed. For the generation of onboard electricity, a generating set (genset) installation is assumed. This is only required for the fuel-oil and hydrogen internal combustion engine variants, which are considered to be similar in terms of cost. Therefore, the cost for a genset was not considered in the analyses.

### Fuel cell (FC) propulsion systems

The TCO analysis also covers the application of fuel cell systems for power generation in vessels. Note that a fuel cell system requires additional equipment to convert electric power into rotation and propulsion. Apart from the installation of the fuel cells (stacks), an electric motor and battery system are needed for onboard power and propulsion.

Based on the HyChain model for hydrogen production costs (ISPT, 2019), the lifetime of fuel cells is assumed constant for all years; it is 10 years based on available literature and expert estimates. The cost for the fuel cell system per kW is indicated in Figure 14, which shows the expected cost developments for future decades. A cost decrease trend has been assumed for fuel cell stacks by using the cost trend for electrolyzers, as these are on a similar technology path.

From the publicly available estimations of the cost decrease for fuel cell systems, a range of 42-65% is used (Horvath, 2017).

Fuel cell systems have higher energy efficiency for power generation. The assumed difference in efficiency of energy-to-propulsion power is 55%, compared to 40% for internal combustion engines (DNV GL, 2019), meaning fuel cells provide similar propulsion power using less fuel than combustion engines. The higher energy efficiency of a vessel powered by a fuel cell system is accounted for in total fuel use of the systems in the analysis.

Fuel cell powered vessels need a battery pack to fulfil the energy demand for peak loads in situations such as manoeuvring in port and during harsh weather conditions at sea. The installed battery pack capacity is independent of installed propulsion power and is higher for ship types with a greater use of energy onboard, such as ferries and cruise vessels. An average battery capacity of 2.5 MWh for ferries and cruise ships, 3.75 MWh for bulkers and containerships and 1.25 MWh for general cargo vessels and other ship types has been assumed, based on (Korberg, Brynolf, Grahnbl, & Skova, 2021).

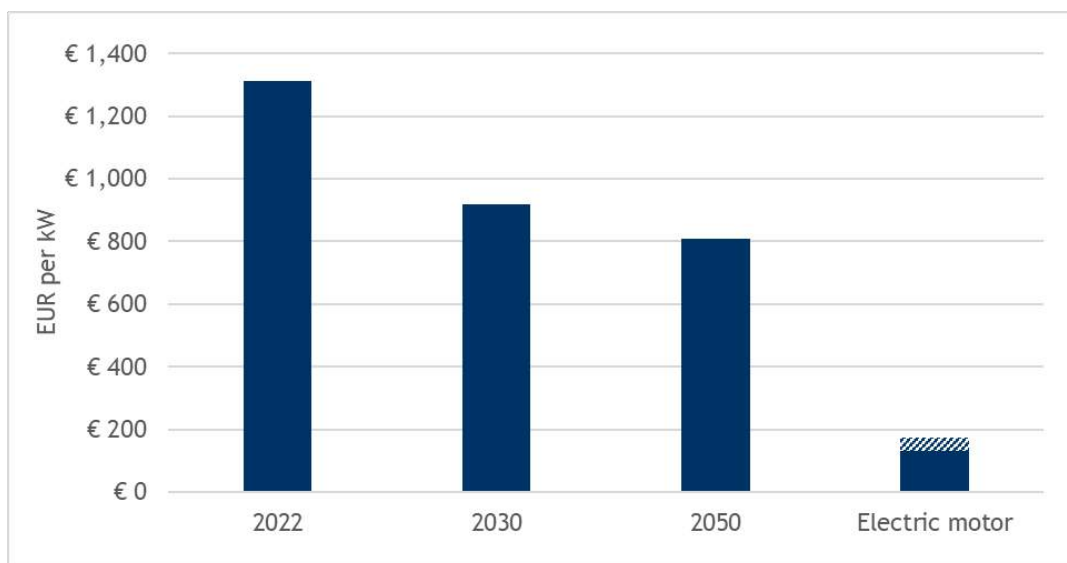

Figure 14. Fuel cell stack cost developments and electric motor costs, the latter depending on engine power

The cost for battery packs is expected to decrease over time, as indicated in Figure 15. based on projections for the battery costs for lithium-ion systems made by the US National Renewable Energy Laboratory (Wesley, Cole, Frazier,

& Augustine, 2021). After 2050, there is limited data on how the costs of a battery pack will develop. Therefore, no further cost decrease is assumed. Within the lifetime of the vessel the stack will need to be replaced approximately every 10 years.

The battery system excluding the cells (the pack) includes systems for controls, wiring and fire prevention. The lifetime of these systems is assumed to be 25 years, similar to the projected lifetime of the ships. The lifetime of a battery pack is assumed to be 12.5 years, based on (Kim K. , Roh, Kim, & Chun, 2020) and lifetime of the battery remains equal over time according to expert estimates.

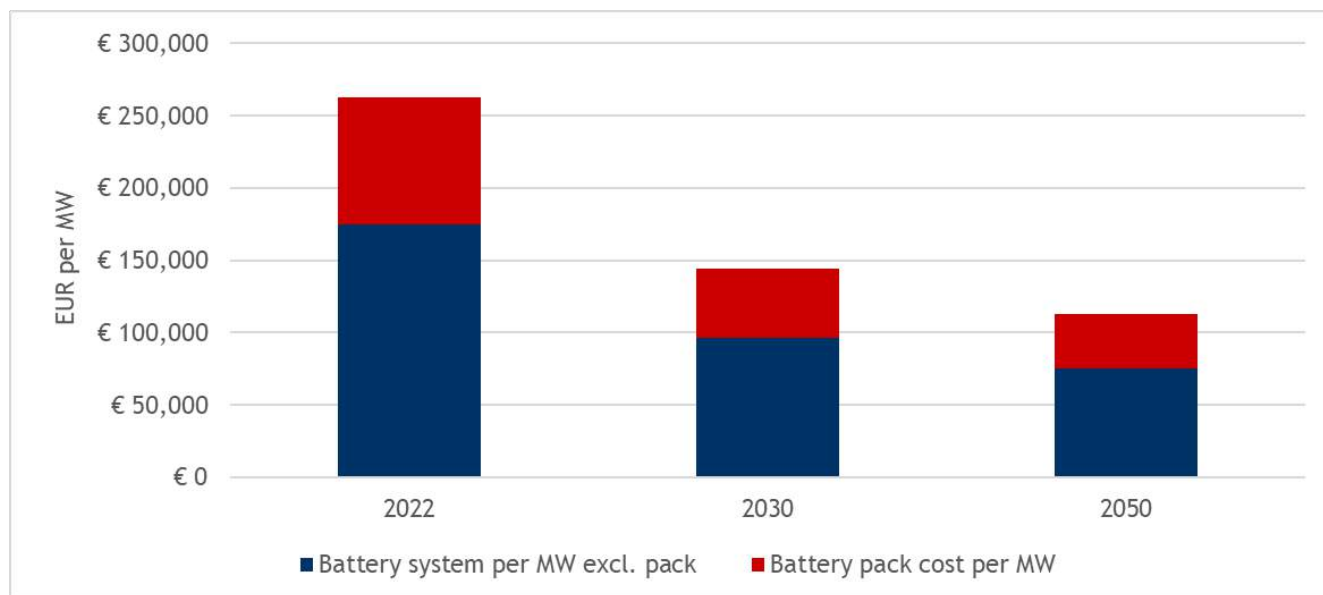

Figure 15. Battery system cost development

### **After-treatment system cost**

After-treatment costs are those borne by the shipowner for the system and the treatment of harmful substances or elements that regulation prohibits the release of into the environment. Vessels powered by fuel oil and hydrogen (using a dual-fuel engine) require an after-treatment system for the NO<sub>x</sub> residuals from the fuel-combustion process. A selective catalytic reduction system (SCR) is used to treat the exhaust and to bring the NO<sub>x</sub> emissions into line with the regulatory limits. The after-treatment system for the fuel-oil reference and hydrogen dual-fuel systems is similar and therefore not quantified. Nonetheless, shipowners should be aware of this cost when considering the investment in a new vessel.

### **Onboard storage, fuel tank and piping**

As explained earlier, for the supply and storage of the fuels, dedicated onboard tanks and piping systems are needed, as part of the fuel supply system. The cost for storage and the fuel supply system (i.e., dedicated onboard tanks and piping systems) is assumed to be proportional to the volume of bunker capacity required for each specific vessel. Both storage tanks and fuel supply system are assumed to have a lifetime of 25 years with maintenance (this will be covered in the OPEX section).

To calculate the cost for the onboard storage tanks, their size needs to be calculated for each ship category. First, the bunker capacity (in tonnes) of the vessels powered by VLSFO and the volume that the storage tanks take up on a vessel was calculated. This is calculated by establishing ratio of bunker capacity to DWT for the ship type. A ratio is used because some vessel types consume more fuel (per day or per distance) due to their services (e.g., cruise vessels have a relatively higher onboard energy demand compared to a general cargo ship). This ratio was obtained from the Clarksons World Fleet Register and calculated for the relevant ship types (an overview of bunker capacity ratios by DWT can be found in Appendix V – Additional Details of the TCO Modelling for Hydrogen-Fuelled ships). Using the average DWT per size class, the bunker capacity for every ship type and size was estimated.

Consequently, the size of the onboard fuel storage tank(s) was calculated using the volumetric energy density of VLSFO.

Due to the lower volumetric energy density of hydrogen, a newly built hydrogen-powered vessel would have a lower energy capacity for the same storage volume; the shipbuilder could increase the storage at the cost of the cargo capacity, however, this would impact the business case for building and operating the vessel.

In the analysis, the first case was considered, by examining only coastal vessels, which can more readily increase their bunkering frequency. It should be noted that by increasing fuel-storage capacity, the cargo capacity is affected. Since this has an impact on the business case for the ship, it has been considered that vessels do not change their bunker-storage capacity.

Using the volumetric density of liquefied hydrogen, the feasible storage capacity within the cubic limits of the reference vessel was calculated. The total storage cost for vacuum-insulated Type C tanks suitable for the storage of hydrogen (by kg) according to (Korberg, Brynolf, Grahnbl, & Skova, 2021) was calculated, establishing a cost per tonne for the fuel-storage capacity (see Table 17). Due to the need of reducing the heat ingress a 'sphere'-shaped Type C tank is chosen for hydrogen storage, a loss of storage volume was assumed. The ratio of volume inherent in the spherical tank was 0.5236 of the cubic form.

Table 17. Storage tank and FSS cost

Ship category	Bunker fuel storage type	Storage and FSS cost per tonne bunker (EUR)
All vessel types	Fuel oil	€1,000
All vessel types	Liquefied Hydrogen	€50,310

The analysis of storage feasibility shows that certain ship types may be able to install hydrogen storage tanks on deck (e.g., ferries and cruise ships); for other ship types (bulkiers, general cargo vessels), their designs would make this very difficult. Therefore, the TCO for coastal vessels, which are more likely to fit storage tanks on deck (and due to lack of cost data for other storage designs) is outlined. For other ship types, ship designs could be adjusted to incorporate hydrogen storage tanks below deck and at common locations for fuel bunkering, however these cases could not be quantified in this study.

### 2.5.3 OPEX

A shipowner's OPEX are variable, depending on the use of the vessel. The OPEX comprise fuel expenditures, carbon costs (see following section) and the costs for bunkering, maintenance and repair and crew training. There are other operational expenditures which have not been considered in the cost analysis, as it is assumed that these costs will be similar for the fuel oil-powered and hydrogen-powered vessels referenced.

#### **Carbon cost**

The maritime shipping sector is on course for inclusion in the European Union Emissions Trading System (EU ETS). From 2024, shipping companies will be obliged to surrender allowances for the CO<sub>2</sub> emissions that their ships emit on voyages to and from, as well as at, ports in the European Economic Area (EEA). Carbon costs will be accrued if, within the geographical scope of the EU ETS, fossil fuels are combusted onboard ships (for more details see subsection 3.3).

To calculate the carbon costs as part of the TCO analysis, a carbon cost of €46 per tonne of CO<sub>2</sub> in 2030 (EC, 2021e) and €150 per tonne CO<sub>2</sub> in 2050 (EC, 2021d) were considered. In addition, it is assumed that carbon costs accrue for each tonne of CO<sub>2</sub> emitted, meaning they are abstracted from the proposed phase-in period and it is assumed that the vessels sail solely on routes between EEA ports; this is plausible, as only relatively small ships used for coastal shipping in Europe were considered.

For the CO<sub>2</sub> emitted on voyages between EEA and non-EEA ports, only 50% of the emissions allowances will need to be submitted, lowering carbon costs on these voyages. And if vessels do not call at EEA ports, the baseline costs for VLSFO also will be lower than assumed here, at least provided that no other policy measures, implementing a

carbon cost, were adopted at international level/in other regions. Hydrogen fuelled vessels have no tank to wake (TTW)<sup>10</sup> carbon emissions and are therefore not subject to carbon cost (EC, 2003). This is also assumed for the pilot fuel biodiesel, which is assumed to be the ignition source for hydrogen in an internal combustion engine.

Figure 16 illustrates the 2030 and 2050 carbon costs per tonne of VLSFO for the above-mentioned carbon costs under ETS. For biofuels, it is assumed that the TTW CO<sub>2</sub> emissions are zero.

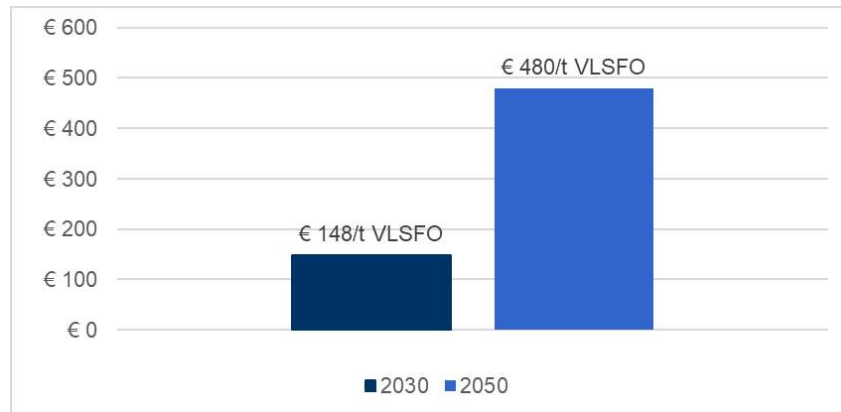

Figure 16. Carbon cost per tonne of VLSFO

## **Fuel cost**

Fuel costs are another major cost item when operating a vessel. They include the production costs, transportation, storage and reconversion (if relevant) of the fuels. The total fuel cost for a specific vessel type is calculated by the yearly average (total) of fuel used. The fuel types considered include fuel oil (VLSFO) (IMO, 2020), biodiesel (as a pilot fuel for the hydrogen dual-fuel internal combustion engine) and liquefied hydrogen (from a *green* and *blue* production pathway<sup>11</sup>); the cost were calculated using the HyChain model (ISPT, 2019)<sup>12</sup>. In Figure 17 the cost of fuels in EUR per GJ is given, for which the gravimetric energy density (MJ/kg) of the fuels has been used, as per Table 1.

The production cost of green (liquefied) hydrogen is the lowest when the hydrogen follows an ammonia transport pathway. That means the demand for green hydrogen is fulfilled by importing green ammonia, which is converted to liquid hydrogen at the bunkering ports. For the ignition of hydrogen, in an internal combustion engine pilot fuel is required; this assumed to be biodiesel, because it is a sustainable fuel.

<sup>10</sup> TTW emissions are those emissions only considered from the combustion of the fuel onboard the vessel, and not emissions borne by the production process of any technology or fuel used.

<sup>11</sup> Green hydrogen is produced by electrolysis process using green electricity (i.e., electricity produced by solar or wind power). Blue hydrogen is produced from steam-reformed natural gas, and the CO<sub>2</sub> emissions from the process are captured and stored.

<sup>12</sup> Figures for blue hydrogen are from own calculations for this project, using the natural gas and synloop cost in HyChain model.

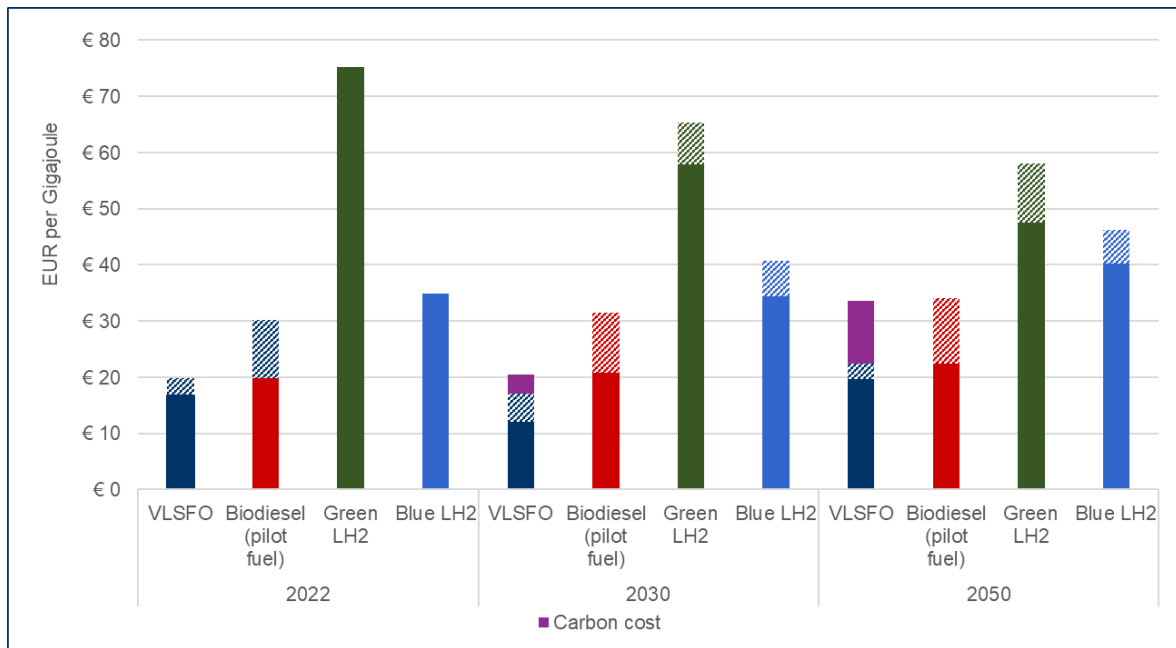

Figure 17. Development of fuel costs including carbon costs

The price of fuel oil is taken from European Commission sources and expressed in cost per energy unit (GJ). Estimations for future fuel costs have an uncertainty margin, which is indicated by the shaded parts of the bars in Figure 17. The uncertainty margin represents the low and the high price estimations as given in the literature. To provide an indication of the impact of the carbon cost on the maritime sector operating on routes to and from EEA ports (EU ETS), the carbon cost for VLSFO is also shown in these figures<sup>13</sup>.

The cost for green hydrogen is currently more than seven times higher than VLSFO; it is about six times higher for blue hydrogen. In the coming decades, the production cost for (green and blue) hydrogen is expected to fall significantly, resulting in a lower market price. Nevertheless, the cost for (liquefied) hydrogen is not expected to reach cost parity with other fuels (such as VLSFO) without carbon pricing. By 2030, with the carbon costs factored in, the gap in the fuel cost between VLSFO and hydrogen will have decreased significantly. In 2050, carbon pricing following the current estimated carbon price does not result in a fuel cost parity of hydrogen to VLSFO. However, depending on the market and carbon cost developments, the cost for VLSFO may be higher than hydrogen.

Regarding the fuel consumption in 2030 and 2050, a 20% improvement in energy efficiency for all vessels is assumed; this is mainly achieved by efficiency improvements onboard the ships and adjustments in how they operate, in line with the sector's energy-efficiency mandates. This will result in a 20% reduction of fuel use in energy terms (GJ).

### **Bunkering cost**

Bunkering costs include those accrued from storing the fuel in port and delivering it to the ship. They vary depending on the type of fuel and are estimated proportional to the yearly energy consumption. These costs are calculated using the methodology provided by the Netherlands Organisation for Applied Scientific Research (TNO, 2020a) (TNO, 2020b).

The bunkering cost for liquefied hydrogen is assumed to be double that of LNG, due to the need to modify bunker ships to carry hydrogen, with its lower energy density and additional requirements for tank insulation and safe operation.

Liquefied hydrogen has a significantly lower volumetric density compared to fuel oil; a vessel powered by hydrogen would require more bunkering stops to perform the same transport work (as a VLSFO-fuelled ship, for example). The

<sup>13</sup> The calculation of the carbon cost is based on the estimated ETS allowance price, converted to cost per tonne (figure 16). From this, using the energy density of VLSFO (MJ/kg), the carbon cost are converted to EUR/GJ. Similarly, the cost per GJ for the hydrogen fuel variants are where possible taken from the literature in EUR/GJ, and where given in EUR/tonne converted by the energy density of hydrogen as given in 2.1.1.

difference in volumetric density is about 4.2 for hydrogen compared to fuel oil, meaning one litre of liquid hydrogen has only about 23% of the energy content of a litre of VLSFO.

Considering similar onboard space for fuel storage, a hydrogen-powered vessel would have to increase its bunkering frequency by more than four times compared to a similar vessel bunkering fuel oil; in practice, this may become an obstacle. It also would lead to an increase of 4.2 times in the bunkering cost, aside from the cost of developing a hydrogen-bunkering supply chain (as discussed in the previous section on storage, distribution and production).

### **Maintenance and repair costs**

Maintenance and repair costs have been accounted for as a yearly cost for every ship category although, in practice, they probably occur irregularly for several components of systems equipment.

A proportion of the ships' CAPEX is considered for such costs. For vessels with internal combustion engines, this cost element is assumed to be 2.5% of the CAPEX independent of the fuel type, while for fuel cell systems are assumed to be about 1% of the CAPEX (Kim K. , Roh, Kim, & Chun, 2020). However, because hydrogen fuel cell-powered vessels are associated with a higher CAPEX, the maintenance and repair cost in absolute terms will be higher for these vessels.

### **Training costs**

The use of alternative fuels involves different risks associated with fuel handling, which is why extra crew and/or extra crew training can be expected. In line with the approach to estimate the cost of crew training provided in (EC, 2021a) +/- 23 crewmembers (depending on the ship type) and two crew groups per vessel are assumed; the crew training cost is assumed at €50 per hour for five days.

The minimum crew-training cost is ~ €137,000 (2 crews \* 23 members \* 5 days \* 8 hours/day \* (€24.5 labour costs per hour + €50 training fee per hour), all based on (EC, 2021a). The training cost may occur over several years when a hydrogen-powered vessel is taken into service because the crew cannot be trained all at once.

## **2.5.4 TCO Retrofit**

Until this subsection, the TCO analysis has focused on the comparison between the costs for newly built VLSFO-fuelled vessels and newly built hydrogen-fuelled vessels.

In this subsection, the cost for retrofitting conventional, existing VLSFO-fuelled vessels to become hydrogen-fuelled vessels equipped with a hydrogen internal combustion engine is considered. A retrofit of this type requires the replacement of the engines, the fuel supply system and the tanks, leading to retrofit-CAPEX. At the same time, costs for the planning and execution of the retrofit and the required approvals need to be considered.

An estimation is given for the costs of the retrofit for three different ships. The differences of the operational costs between the conventional VLSFO-fuelled ship and the retrofitted ship are the same as determined in the TCO analysis for the new building (see subsection 2.5.3), and therefore are not re-examined here.

The following costs also accrue, however, due to the difficulty to estimate, have not been quantified:

- Revenue losses from the time ship is out of service during the retrofit
- Depending on contracts, any additional costs from retaining the crew while the vessel is idle
- Extra fuel expenditures for rerouting to and from the shipyard

For the quantified retrofit costs, the uncertainty is relatively high since there is limited experience from which to draw. Therefore, project retrofitting costs from LNG retrofit cases, hydrogen system CAPEX and expert estimations for engineering, fitting and the installation of hydrogen systems have been applied.



More specifically, an estimate of the project cost for retrofitting vessels to a dual-fuel LNG propulsion system was used (MAN Energy Solutions, 2022). Also, the cost for shipyard work, supply and logistics and verifier cost were used from MAN-ES, which are unrelated to the type of engine and ship type.

CAPEX costs from the TCO model for the newly built vessel are used for the hydrogen internal combustion engine, the fuel-supply system and the storage tanks, which all need to be purchased as new. The engineering, fitting and installation costs are 30% of the system CAPEX costs, as suggested by industry experts. Altogether, this provides the costs for the retrofit to hydrogen-fuelled vessels presented in Figure 18.

The vessels in this part of the study are: a Supramax bulk carrier (65k DWT), a mid-range tanker (50k DWT) and a small container vessel (5k TEU), with an installed engine-propulsion powers of 10MW, 9MW and 40MW, respectively. These are ship sizes which may be able to cover most of the common voyage distances without extra refuelling, even though the stored energy content is significantly lower for hydrogen than VLSFO. (See subsection 2.4 on suitability for an outline of practical application and usage of hydrogen in shipping.)

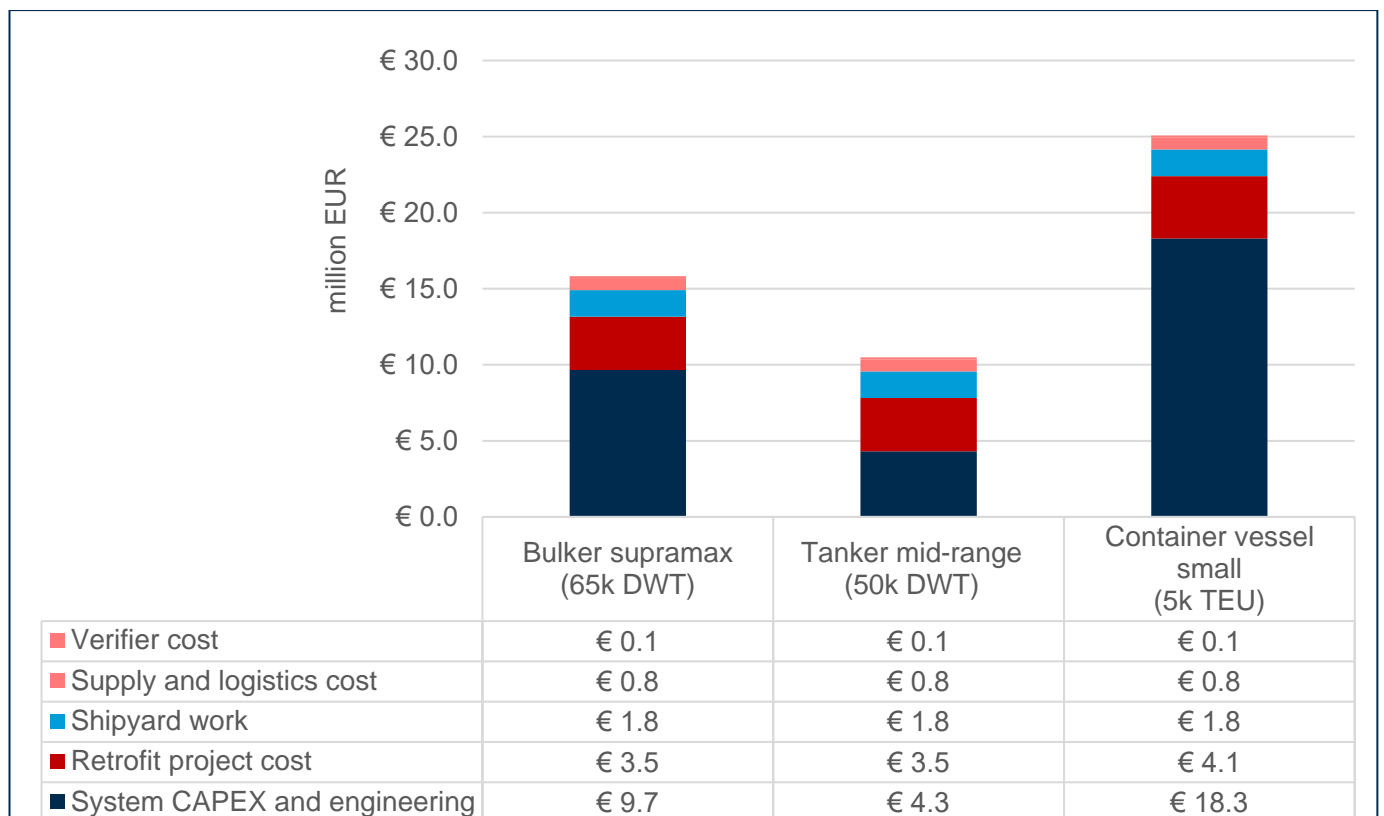

Figure 18. Total cost of retrofitting (million EUR) conventional fuel to hydrogen ICE system

Considering the quantified and non-quantified cost items, it can be concluded that retrofitting a conventional fossil-fuelled vessel to a hydrogen-fuelled vessel is a costly exercise. The total cost for retrofitting a small bulker is approximately €15m, for a mid-range tanker around €10m and for a small container vessel it is approximately €25m. The higher cost for the container vessel is due to the higher cost for the internal combustion engine system; as yet there are no economies of scale in the manufacture of the higher propulsion power engines (over 2.5 MW) that are considered for this ship type. This may be a factor of uncertainty in the analysis.

In Table 18 the retrofitting costs, as an annuity, are compared to the additional CAPEX (annuity) for a newly built hydrogen-fuelled vessel for the same vessel type and similar size. From this comparison, it can be concluded that retrofitting costs are about double the additional CAPEX for the newly built ship.

Table 18. Comparison of annual CAPEX for retrofitting and newly built hydrogen combustion systems

	Bulker Supramax (65k DWT)	Tanker Mid-range (50k DWT)	Container vessel Small (5k TEU)
Retrofitting to hydrogen combustion system	€1,420,000	€940,000	€-2,250,000
Additional newbuilding cost of a hydrogen-combustion system	€630,000	€420,000	€-1,725,000

## 2.5.5 TCO New Building Estimation

In this section, the results of the TCO analysis for hydrogen-powered vessels are presented. The aim is to provide an indication of the total cost of a newbuilding for shipowners, focusing on 2030 and 2050 and to show the cost difference to the reference vessels powered by VLSFO, the current conventional powertrain in shipping.

For each vessel type and size, both the TCO for the reference VLSFO vessel and the vessels operating on hydrogen is calculated. It is outlined in detail for the two vessel categories assumed to be operational on intra-EU voyages, where the (VLSFO) reference EU ETS carbon cost would apply. Considering the previous limitations and practicalities for hydrogen-powered vessels, the TCO for vessels operating at mid-range distances are presented. The two vessel categories are a ferry Ro-Pax vessel (2,000-4,999 GT) and a *Ro-Ro cargo* vessel (5,000-9,999 DWT), as these ship types are thought to have fewer difficulties applying hydrogen-powered propulsion systems, given their relatively higher frequency of port calls and ship designs<sup>14</sup>.

Also, the TCO is presented for an LNG carrier (174k m<sup>3</sup>) using the TCD process, despite the low TRL level, in order to explore the possibility of using hydrogen onboard bigger vessels engaged in longer voyages.

### Ferry Ro-Pax

Ferry Ro-Pax vessels operate on short- and mid-range distances to transport passengers and goods, e.g., by truck. This type of ship may be among the first to apply hydrogen as they often sail on fixed routes. A hydrogen-infrastructure chain is likely to be set up in ports where a reasonably stable demand for hydrogen exists, making investments in storage and bunker facilities possible.

The additional annual TCO for the size of ferry Ro-Pax vessels under consideration is indicated in Figure 19 for green and blue liquefied hydrogen with internal combustion engine and fuel cell systems, compared to an equally sized ferry Ro-Pax running on VLSFO.

On the left-hand side of the figure, the projected absolute difference in TCO is displayed in total and disaggregated by cost item. The right-hand side of the figure shows the relative differences of the cost items. A difference of 0% means equal costs compared to the reference case and a difference above/below 0% means higher/lower costs compared to the reference case.

<sup>14</sup> On-deck storage tanks may be fitted relatively easier compared to other common ship types



Figure 19. Additional yearly TCO for hydrogen-powered Ferry Ro-Pax vessels (2,000-4,999 GT).

The results show a significantly higher TCO for a ferry Ro-Pax powered by hydrogen compared to one powered by VLSFO. This holds for both green and blue hydrogen and is more pronounced in 2030 than in 2050.

The higher additional TCO of hydrogen-powered vessels equipped with an internal combustion engine are dominated by the additional fuel costs. The decrease in the price differential between VLSFO and hydrogen between 2030 and 2050 projects a significantly lower additional TCO in 2050.

Ships equipped with fuel cells are more efficient, which is why the additional fuel costs are lower. In addition, the 2050 price differential (including carbon costs) between VLSFO and hydrogen is expected to be relatively low. This is why the ferry Ro-Pax vessel equipped with a fuel cell power system is, in 2050, expected to have fuel costs even lower than those of the VLSFO-fuelled reference ship. The additional CAPEX then becomes the main driver of the additional TCO. In 2030, this also holds for blue hydrogen, while for green hydrogen, which is more expensive, the higher CAPEX still dominates.

The additional TCO is higher for ships equipped with fuel cell power systems compared to ships equipped with hydrogen internal combustion engines. The lower fuel costs, if fuel cell systems are used, cannot compensate for the higher CAPEX. However, the difference between the additional TCO for ships equipped with fuel cell power systems and hydrogen internal combustion engines is not very high. The additional TCO mainly depends on the type of hydrogen.

The use of hydrogen results in a substantially higher TCO:

- Green hydrogen: In 2030 the TCO is 3-3.1 times higher (+199%/+212% for ICE/FC system) and in 2050 it is approximately 30% higher (+28%/+30% for ICE/FC system) than the TCO for the VLSFO vessel.
- Blue hydrogen: In 2030, the TCO is 2-2.3 times higher (+96%/+124% for ICE/FC system) and in 2050 it is approximately 15% higher (+12% / +15% for ICE/FC system) than the TCO for the VLSFO vessel.

The difference in TCO between the VLSFO reference and hydrogen-powered vessel may be lower in 2030 and 2050, depending on developments in the global bunker price for fuel oil, the carbon cost and any technological progress. On the other hand, Figure 17 shows the cost comparison for low-fuel price scenarios. This means that the cost difference between the TCO of hydrogen- and VLSFO-powered vessels also could be more pronounced than presented here. For the outcomes of the high-price scenario, please see Appendix V.

**Ro-Ro cargo vessel**

Ro-Ro cargo vessels are also likely to qualify soon for operating on hydrogen as they trade across short- and mid-range distances. The additional annual TCO for Ro-Ro vessels (5,000-9,999-DWT) is depicted in Figure 20 for green and blue hydrogen compared to the TCO of an equally sized Ro-Ro vessel running on VLSFO.

On the left-hand side of the figure, the projected absolute difference in TCO is displayed in total and disaggregated by cost item. The right-hand side of the figure shows the relative differences of the cost items. A difference of 0%

means equal costs compared to the reference case and a difference above/below 0% means higher/lower costs compared to the reference case.

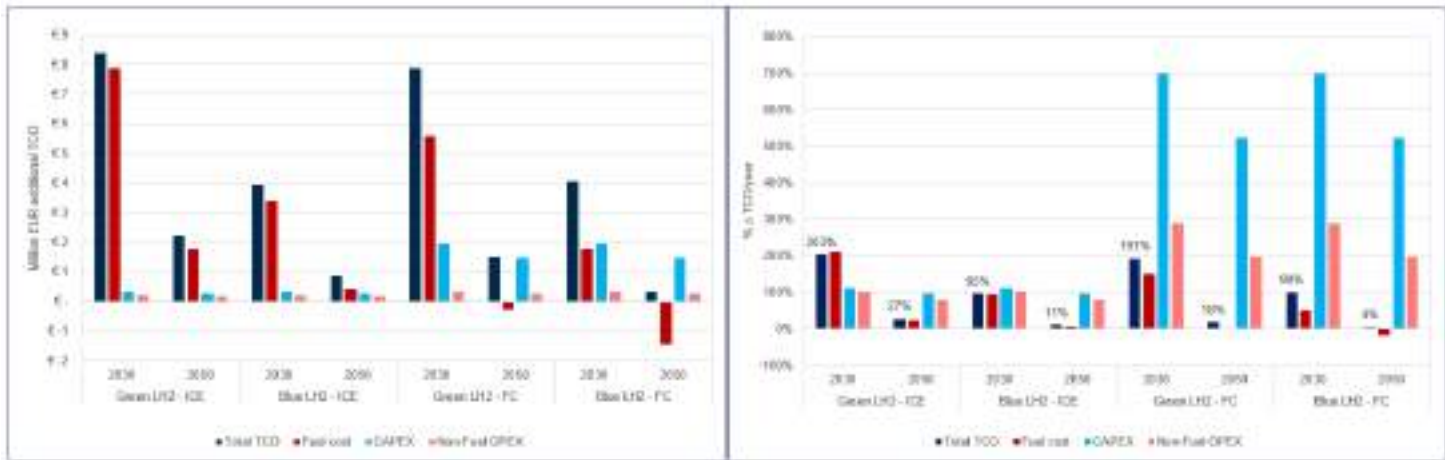

Figure 20. Additional yearly TCO for hydrogen powered Ro-Ro cargo vessel (5,000-9,999 DWT)

The results show a significantly higher TCO for a Ro-Ro vessel powered by hydrogen compared to the baseline (VLSFO-fuelled) Ro-Ro vessel. This is the case for green hydrogen and for blue hydrogen.

The right-hand side of the figure indicates that the fuel cost of hydrogen (for both 'green' and 'blue') will be lower in 2050 than the fuel cost of the VLSFO reference Ro-Ro vessel, due to the increases in fuel cost created by the carbon pricing (€480/tonne for VLSFO in 2050) for the reference vessel. For Ro-Ro vessels with a fuel cell powertrain, the fuel cost is even smaller due to the higher energy efficiency of the fuel cell and electric propulsion system compared to the internal combustion engine propulsion. However, due to the significant CAPEX, the total cost remains higher than for a conventionally fuelled Ro-Ro vessel.

The analysis indicates that the TCO of a Ro-Ro vessel using hydrogen, regardless of the production method, will remain higher for the next few decades than for the TCO of a same-sized Ro-Ro vessel burning fuel oil. However, this is dependent upon developments in the international prices for fossil fuel and carbon emissions.

The CAPEX is a major cost item in the fuel cell variants. The results show a significantly higher yearly CAPEX of approximately €2m in 2030 compared to the baseline vessel. The reason lies in the fact that the cost for fuel cell systems per kW of installed power is significantly higher and the fact that the fuel cell stacks will need to be replaced once during the lifetime of the vessel.

In 2050, the TCO for a blue hydrogen-powered Ro-Ro vessel may be equal to the baseline VLSFO Ro-Ro ship paying a carbon price of €150/tCO<sub>2</sub>. Thus, cost parity may be feasible under higher fossil-fuel prices and carbon pricing; if no carbon costs accrue, the TCO business case for hydrogen-powered Ro-Ro vessels will decline.

In Appendix V, there are additional details of the TCO modelling for hydrogen-powered ships. The TCO analysis for hydrogen-powered Ro-Ro vessels in the same size category is also given for a higher fuel price scenario.

### **LNG carrier: Natural gas to hydrogen decomposition**

In this subsection, a case study is presented for a newly built LNG carrier that uses its LNG cargo as its energy supply and which is equipped with a system that allows for the onboard decomposition of LNG (to gas/hydrogen) as well as carbon capture, a technology currently under development. For this case study, the data used were mainly provided by the technology provider<sup>15</sup>.

The system decomposes natural gas to a decomposition gas consisting of 80% hydrogen and 20% natural gas. This decomposition gas is compressed at 15 bar and used by the ship's main engines, generators and boilers. This would require using an engine system, generators, boilers and compressors that are able to handle the decomposition gas, increasing the CAPEX for the newbuilding. In addition, the ship's energy consumption would increase due to the

<sup>15</sup> Rotobooast was able to provide information and data for the decomposer system they develop.

additional energy required for the decomposer unit and the compressors. Energy is lost when natural gas is converted into hydrogen and solid carbon, because only the hydrogen is combusted.

The LNG consumption increases significantly (+120%, in this case provided by the technology provider). Nevertheless, the process results in a net TTW (tank-to-wake) CO<sub>2</sub> reduction due to the CO<sub>2</sub> that is captured by the decomposer unit (approximately -40%). The carbon is stored as solid carbon onboard the ship. Since solid carbon can be used by the industry (e.g., to produce graphite in components such as in batteries and fuel cells, which are all components that are needed to accelerate the transition to sustainable fuels), it has a positive market value.

The decomposition gas also can be further purified onboard the ship, which would allow it to be propelled by pure hydrogen instead of decomposition gas. This increases energy consumption even further (around +250% compared to baseline). At the same time, it would also result in a higher net TTW CO<sub>2</sub> reduction (around 70%) and generate a higher amount of solid carbon.

In the following, the focus is on the first option, without further considering onboard purification of the decomposition gas. The TCO total cost of ownership is calculated for a newly built LNG carrier (174k m<sup>3</sup>), following the same method as applied in the preceding TCO analyses. Nevertheless, some equipment items are different.<sup>16</sup>

In the base case, a natural-gas system and an LNG internal combustion engine are assumed. As per the calculations of the decomposer provider, the daily fuel consumption for the LNG carrier is 82 tonnes at 100% engine load. An average engine load of 75% has been assumed to assess its contribution to the TCO, in which fuel consumption falls to an assumed level of 70%, revealing a daily baseline consumption of 57 tonnes. The costs of onboard NG compressors are included for low-pressure delivery to the engine.

The newly built LNG carrier is equipped with the decomposer system described above, a modified engine system (modified dual-fuel LNG-ICE suitable for the combustion of decomposition gas, with 2% VLSFO pilot fuel consumption) and modified generators. The tank system is assumed to be unchanged as the bunkered fuel is also LNG in the case study. The total LNG consumption in the decomposer case increases by 122% to 182 tonnes per day (at 100% engine load). The assumptions are: an average engine load of 75% and a fuel consumption of 70%, making LNG consumption 127.6 tonnes per day. The use of pilot VLSFO is assumed to remain constant. The decomposer system produces 95 tonnes of solid carbon per day which is stored onboard.

According to the provider of the decomposer, the price of solid carbon can be expected to be US\$700-\$1,200 per tonne. In the central scenario shown in Figure 21, a price of US\$925 per-tonne is assumed and lower and upper boundaries to that range is indicated in Figure 21.

Regarding the fuel prices, the assumptions in the central scenario are: an LNG price of \$1,500/tonne (€1,423/t), corresponding to \$31/GJ, which was the average price for LNG in Rotterdam from November 2020 to February 2023 (according to shipandbunker.com). For the 'optimistic' and 'pessimistic' scenarios, the maximum and minimum prices for LNG in this period (\$4,545/tonne or \$95/GJ and \$400/tonne or \$8/GJ respectively) have been assumed.

The VLSFO price, which is relevant to the pilot fuel, is in line with the price as assumed in the TCO analyses presented above.

Figure 21 presents the additional yearly CAPEX, fuel cost and carbon revenues for the LNG carrier with an NG-to-H<sub>2</sub> decomposer onboard. For the base and decomposer cases, an annuity of the total CAPEX is calculated and subtracted from each to obtain the yearly additional CAPEX for the decomposer case. The yearly TCO is the sum of the CAPEX and fuel cost and the positive revenues from the carbon production in the decomposition process.

As Figure 21 illustrates, the business case is highly dependent on the market prices for solid carbon and LNG bunkers. The latter is very volatile and differs structurally between regions. For the LNG price as assumed for the central scenario (\$1,500/tonne), the break-even price for solid carbon amounts to \$1,160/tonne, which roughly corresponds to the upper boundaries of the price range for solid carbon provided by the provider of the decomposer.

It is acknowledged for the viability of this concept to be demonstrated, there are several elements that need to be further analysed, such as the storage of big quantities of carbon onboard. For the specific ship type, the storage space onboard is not expected to be a barrier.

---

<sup>16</sup> Maintenance costs might be higher as well. It was not possible to quantify this difference.

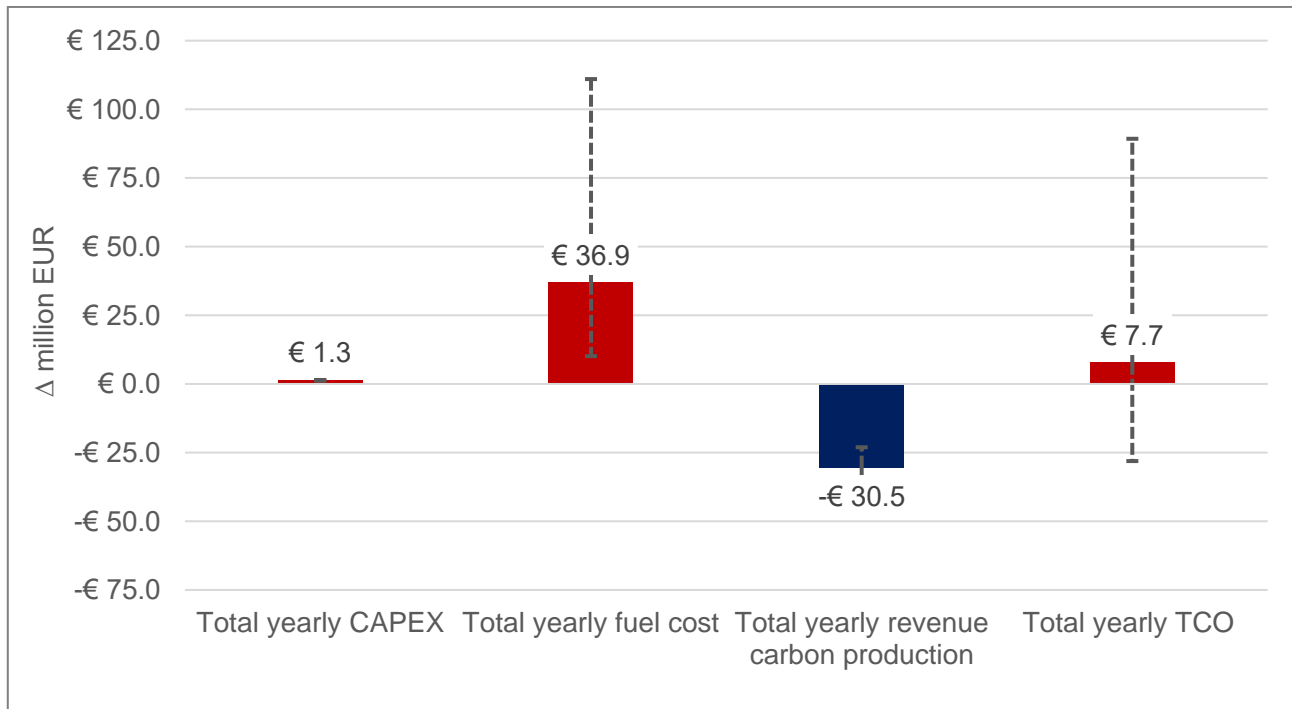

Figure 21. Additional annual costs/benefits if a NG to H<sub>2</sub> decomposer system is installed and used on an LNG carrier

### 2.5.6 Techno-Economic Conclusions

The TCO for hydrogen-fuelled vessels running on blue or green hydrogen appears to be higher than for ships running on conventional fuel oils. Due to the practical limitations on the use of hydrogen in long-range shipping, the TCO was outlined for a few vessel types which are deemed to be suitable for hydrogen application from a technical viewpoint.

The example cases of ferry Ro-Pax and Ro-Ro vessels suggested an additional TCO for green hydrogen that is about 3 times higher than vessels powered by conventional (fossil) fuels in 2030 and about 20 to 30% higher in 2050. For vessels powered by blue hydrogen, the TCO may reach cost parity in 2050. However, this is only feasible if carbon costs apply to fossil fuels. If no carbon costs accrue, the TCO for the hydrogen-powered vessels analysed might, in a high price scenario, remain up to four times higher than the TCO of the conventional vessels.

Ship-owners will not be able to use hydrogen-powered vessels in the highly competitive transport market due to their significantly higher CAPEX and OPEX than conventionally fuelled ships. Moreover, there are practical and financial concerns about developing sufficient hydrogen production and facilities to store and bunker the fuel in and around ports. Besides, the cost retrofitting existing vessels to use hydrogen is approximately twice as expensive as a newly built hydrogen fuel system, or simply not cost-effective.

Without policy measures to either bridge the price gap or oblige ships to use green fuels, a transition towards hydrogen with its low- or zero-CO<sub>2</sub> impact is unlikely to take place in the next decade. Market demand for carbon-free maritime transportation could be a complementary or an alternative way to achieve a transition towards green fuels.

However, the business case for hydrogen-powered vessels also will be dependent on developments in the global price of fuel oil. If fossil fuel prices continue to rise, the cost gap between the TCO for using conventional fuels and the TCO for hydrogen may be tightened.

The storage of hydrogen, either as a liquid or compressed, will be a challenge for certain ship types. Shipping operators active on short-sea routes – primarily coastal vessels – might take up hydrogen-powered vessels, as they

would not have to add an extra port call to accommodate more frequent bunkering. Vessels may have to bunker during each port call if hydrogen bunkering infrastructure becomes available.

A case study investigating the application of an LNG to hydrogen/decomposition gas decomposer installed on a newly built LNG carrier shows that the TCO for a hydrogen-fuelled ship does not necessarily have to be higher than for the LNG-fuelled counterpart. This, however, highly depends on the LNG fuel price and the price that can be achieved for the solid carbon stemming from onboard decomposition.

## 3. Safety and Environmental Regulations, Standards and Guidelines

This chapter describes the environmental regulations, standards and guidelines available (and under development) relating to the usage of hydrogen.

### 3.1 Introduction: Bunkering, On-board Storage, Handling and Use of Hydrogen

As a clean-burning energy carrier, hydrogen has been used commercially in fuel cells and internal combustion engines to power buses, industrial trucks and equipment such as forklifts. The zero-emission fuel cell-powered machinery has proven particularly beneficial for enclosed spaces such as warehouses and along regular routes where refuelling capacity has been developed. The interest in adopting hydrogen fuel for road use has been increasing -- in concert with electric vehicles -- on longer routes. However, there is presently a lack of regulation for the use of hydrogen as a marine fuel at national, regional and international levels.

Interest in hydrogen as a fuel has grown in the past few years in the maritime sector, where it could potentially provide a zero-carbon solution.

This section starts with the regulations applicable to the storage, transport and use of hydrogen. It also provides a general overview of the policies driving the demand for renewable hydrogen in shipping.

### 3.2 International

The following subsections identify current global regulations, standards and guidelines related to the application of hydrogen as fuel in the maritime sector.

#### 3.2.1 International Organization for Standardization (ISO)

**ISO 8217:2017** – *Petroleum products – Fuels (class F) – Specifications of marine fuels*

The most widely used fuel standard in the marine industry that covers conventional residual or distillate fuel grades, is ISO 8217; the latest edition was issued in 2017. The ISO 8217:2017 standard, Petroleum products – Fuels (class F) – Specifications of marine fuels, offers the requirements for fuel oils for use in marine diesel engines and boilers prior to conventional onboard treatment. It specifies seven categories of distillate fuels and six categories of residual fuels.

The ISO standard defines fuel as hydrocarbons from petroleum crude oil, oil sands and shale, hydrocarbons from synthetic or renewable sources that are similar in composition to petroleum-distillate fuels. It includes blends of these products with a fatty acid methyl ester (FAME) component, when permitted by the standard. The standard provides detailed specifications for distillate (DM) grades, distillate FAME (DF) grades and residual (RM) grades of marine fuel oils.

*ISO Marine Fuel Standard for Hydrogen?*

In response to growing industry interest and applications for LNG as a marine fuel and demand for an internationally recognised marine fuel standard, the ISO developed the **ISO 23306:2020** standard '*Specification of liquefied natural gas as a fuel for marine applications*', published in October 2020.

As this study went to press, the ISO methanol fuel standard was in preparatory stages as **ISO/AWI 6583** '*Specification of methanol as a fuel for marine application*'.



From these precedents, it can be concluded that an ISO marine fuel standard covering the specification for hydrogen also will be developed. However, this would either require the IMO to make this request to the ISO, or for an ISO member to initiate a new work item through their national administration. So, it would be useful for an EU member state to officially request this from IMO, to support early initiation.

As some of these emerging fuels -- including hydrogen -- are pure substances, industrial specifications are sufficient; the products are not subject to the same variations in fuel property as conventional residual fuel oils. However, the lack of a marine fuel standard is often cited as a barrier to adoption, especially when considering blends of hydrogen with LNG.

Experience with the contamination or impurities of LNG and ethane also suggests a marine fuel specification will be required to document critical fuel properties and limits. These include properties such as water, oxygen, debris, etc., which may be relevant to the tank material and the ability to document the fuel-property test standards for each fuel parameter.

### *ISO Standards for Hydrogen*

The ISO has many standards for the industrial or land-based transportation sectors that may be suitable for marine applications, a sample of which are referenced below.

#### **ISO 14687:2019 Hydrogen fuel quality — Product specification.**

This standard defines the minimum quality characteristics of hydrogen fuel for stationary and vehicular utilisation. It can serve as the basis of requirements for hydrogen fuel for marine applications and could be updated to cover the quality requirements for hydrogen fuel for marine applications.

#### **ISO/TR 15916:2015 Basic considerations for the safety of hydrogen systems.**

This document specifies safety concerns for the utilisation of liquid and gaseous hydrogen. The storage of hydrogen systems, including hydride storage systems, are covered in this standard as well. The hydrogen safety concerns listed in this document cover hazards, risks and safety properties. This document is not limited to one specific application (offshore based, land-based, etc.), so it can serve as a solid reference for marine hydrogen application standards from the perspective of safety systems. The safety requirements for hydrogen handling operations are not covered in this standard.

#### **ISO 13984:1999 Liquid hydrogen — Land vehicle fuelling system interface.**

Although this standard focuses on the characteristics of liquid hydrogen filling and distribution systems for land vehicles, it can be a good reference to reduce fire and explosion risks at the interface between the liquid hydrogen refuelling system and the distribution system. This document specifies the distribution system of liquid hydrogen to land-based vehicles and the cold gaseous hydrogen handling system from the fuel tanks of the vehicles.

#### **ISO 13985:2006 Liquid hydrogen — Land vehicle fuel tanks.**

This document details the specifications for liquid hydrogen fuel tanks that may be refilled, as well as the testing procedures needed to determine the same level of fire and explosion protection. This standard may serve as the foundation for the specifications for liquid hydrogen tanks for marine system applications or it may be amended to include the specifications for liquid hydrogen tanks used in ships. The fuel tanks covered by this document are meant to be permanently attached to a land vehicle.

#### **ISO 22734:2019 Hydrogen generators using water electrolysis — Industrial, commercial, and residential applications.**

This standard specifies the design, performance and safety requirements for hydrogen generators that electrolyse water to create hydrogen through electrochemical processes. It might serve as the foundation for the specifications for the electrolyzers used in marine applications or it might be amended to include such specifications. This document applies to hydrogen generators designed for indoor and outdoor residential use in covered locations, such as carports, garages, utility rooms and similar parts of a home. It also applies to hydrogen generators intended for industrial and commercial uses.

### **ISO 16110 Hydrogen generators using fuel processing technologies.**

This standard is applicable to hydrogen-production systems that transform an input fuel into a compositionally suitable stream of hydrogen, for example, hydrogen consumed in a fuel cell power system. This series may be used as a starting point for the design and safety issues of marine systems intended to produce hydrogen fuel for onboard application.

- **ISO 16110-1:2007 Part 1: Safety** includes all key risks, hazardous circumstances and hazardous events related to hydrogen generators, excluding installation issues.
- **ISO 16110-2:2010 Part 2: Test methods for performance** outlines test protocols for evaluating the performance of hydrogen generators.

### **ISO 16111:2018 Transportable gas-storage devices — Hydrogen absorbed in reversible metal hydride.**

This document specifies the requirements that apply to the selection of materials, design, construction and testing of "metal hydride assemblies" (MH assemblies), transportable hydrogen gas-storage systems that use shells with internal volumes no greater than 150 l and maximum developed pressures (MDPs) no greater than 25 MPa. In refillable storage MH assemblies, where hydrogen is the only transmitted medium, this document is applicable; However, storage MH assemblies designed to be used as fixed fuel-storage onboard hydrogen-fuelled vehicles are not covered by it.

### **ISO 17268:2020 Gaseous hydrogen land vehicle refuelling connection devices.**

This standard specifies the design, operation and safety requirements for refuelling connectors for gaseous hydrogen land vehicles. It applies to refuelling connectors with nominal working pressures or hydrogen service levels of up to 70 MPa, but not to those that dispense hydrogen-natural gas mixtures. This document might serve as the foundation for a new standard for maritime-fuelling systems that use gaseous hydrogen fuel or it could be amended to cover marine operations.

### **ISO 19880 Gaseous hydrogen — Fuelling stations.**

This series applies to public and private fuelling facilities that provide light-duty automobiles with gaseous hydrogen fuel (e.g., electric vehicles using fuel cells). The dispensing of cryogenic hydrogen or the use of hydrogen in metal hydride applications are not covered. The series might serve as the foundation for a new standard for the marine connection devices used for gaseous hydrogen fuel or it could be amended to incorporate marine applications.

- **ISO 19880-1:2020 Part 1: General Requirements** outlines the minimal safety and performance requirements for gaseous hydrogen fuelling stations in terms of design, installation, commissioning, operation, inspection and maintenance.
- **ISO 19880-3:2018 Part 3: Valves** describes the specifications and testing procedures for the safety performance of the high-pressure gas valves used in gaseous hydrogen stations -- including shut-off valves, manual valves, pressure safety valves, excess flow valves, check valves and hose breakaway devices.
- **ISO 19880-5:2019 Part 5: Dispenser hoses and hose assemblies** includes safety standards for the material, design, manufacture and testing of reinforced hoses and hose assemblies for gaseous hydrogen dispensing at hydrogen fuelling stations. It also specifies the requirements for reinforced hoses and hose assemblies.
- **ISO 19880-8:2019 Part 8: Fuel quality control** details the procedure for assuring the gaseous hydrogen's purity at facilities that distribute hydrogen.

### **ISO 19881:2018 Gaseous hydrogen — Land vehicle fuel containers.**

The material, design, fabrication, labelling and testing specifications for refillable containers used to store compressed hydrogen gas are specified in this standard (meeting the ISO 14687 quality standard). The specifications for hydrogen-fuel canisters used in light-duty vehicles, heavy-duty vehicles and industrial-powered trucks such as forklifts and other material-handling vehicles are also included in this document. These specifications could serve as the foundation for specifications for compressed hydrogen storage for marine applications.

### **ISO 19882:2018 Gaseous hydrogen — Thermally activated pressure relief devices for compressed hydrogen vehicle fuel containers.**

This specification is applicable to the thermally activated pressure relief devices used on fuel containers for hydrogen-powered vehicles that meet ISO 19881 (or IEC 62282-4-101, ANSI HGV 2, CSA B51 Part 2, EC79/EU406, SAE J2579, or the UN GTR No. 13) and hydrogen that satisfies ISO 14687 quality requirements. This document also specifies the types of thermally actuated pressure-relief devices that may be used on industrial powered trucks, including forklifts and other material-handling vehicles and light and heavy-duty vehicles. It might serve as the foundation for the specifications for this equipment when it is used in maritime service, or it might be updated to account for marine specifications.

#### **ISO/TS 19883:2017 Safety of pressure swing adsorption systems for hydrogen separation and purification.**

For the design, commissioning and operation of pressure-swing adsorption systems for hydrogen separation and purification, including both stationary and skid-mounted systems, this technical specification defines safety precautions and related design elements. It may be used as a starting point for marine requirements - or changed to incorporate specific marine requirements - if hydrogen separation is utilised in a marine environment.

#### **ISO 26142:2010 Hydrogen detection apparatus — Stationary applications.**

The performance criteria and testing procedures for hydrogen detectors used to assess hydrogen concentrations in stationary applications are specified in this standard. These include selectivity, toxicity, measurement range, stability, reaction time and precision. Although suitable for stationary applications, the standard might be amended to cover marine applications or used as the foundation for requirements of hydrogen detection in maritime applications.

#### *ISO Standards for LNG to Consider*

In addition to the ISO marine fuel standard identified in the subsection above, there are other gaps in the available ISO standards for application of hydrogen as a marine fuel. In this context, the standards developed for the adoption of LNG as a marine fuel can be taken as a precedent; they are detailed below for reference.

#### **ISO 21593:2019 – Ships and marine technology – Technical requirements for dry-disconnect/connect couplings for bunkering LNG.**

For application on LNG-bunkering ships, tank trucks, shore-based facilities and other bunkering infrastructure, this document specifies the design, minimum safety, functional and marking standards, interface types and dimensions and testing processes for dry-disconnect/connect couplings. It does not apply to ISO 16904-compliant hydraulically powered quick connect/disconnect couplers (QCDC) used with heavy loading arms.

#### **ISO 20159:2021 – Ships and marine technology – Specification for bunkering of liquefied natural gas fuelled vessels.**

For equipment used to bunker LNG-fuelled vessels and for LNG bunkering-transfer systems, which are not covered by the IGC Code, the requirements are laid out in this document. Regardless of size, this agreement, which applies to vessels engaged in local and foreign services, addresses hardware, operational procedures, training and qualification personnel, bunker delivery note requirements for LNG providers and requirements for LNG plants to meet the appropriate ISO standards and local regulations.

#### **ISO/TS 18683:2021 – Guidelines for safety and risk assessment of LNG fuel bunkering operations.**

The risk-based design and operation of the LNG bunker-transfer system, including the interaction between LNG bunkering supply facilities and receiving LNG-fuelled vessels, are described in this publication. To develop a bunkering site, facility and LNG bunker transfer system, the requirements and recommendations in this document provide the minimum functional standards, qualified by a structured risk-assessment approach that takes into account the characteristics and behaviour of LNG, concurrent operations and all parties involved in the operation. Both ships and inland commercial vessels may use the bunkering procedures described in this paper. It includes scenarios involving mobile-to-ship and ship-to-ship LNG supply as well as LNG bunkering from land or sea.

These published standards indicate that equivalent hydrogen standards for dry-disconnect/connect couplings, bunkering specifications and guidelines for risk assessment of bunkering operations remain to be developed and therefore are a barrier to adoption.

The latter is of specific relevance to port authorities that wish to assess the hydrogen-bunkering interface (tank-to-ship, truck-to-ship or ship-to-ship) for establishing and permitting purposes. The cryogenic risks and the high expansion ratios are applicable to both LNG and liquefied hydrogen releases, drive the consideration of simultaneous operations and the hazardous areas, safety zones and security zones that will be required for safe bunkering of liquefied hydrogen in port areas.

### 3.2.2 International Maritime Organization (IMO) Requirements

#### 3.2.2.1 SOLAS

The IMO's safety-related regulations for international shipping are regulated through the *International Convention for the Safety of Life at Sea* (SOLAS, 1974, as amended) convention. SOLAS has historically prohibited the use of conventional fuel oils with less than a 60°C flashpoint, except for emergency generator use (where the flashpoint limit is 43°C) and subject to additional requirements detailed under SOLAS Chapter II-2 Regulation 4.2.1. To accommodate the interest in using gaseous and liquid fuels with a flashpoint of less than 60°C, the IMO adopted the *International Code of Safety for Ships using Gases or Other Low-Flashpoint Fuels* (IGF Code) by including a new Part G to SOLAS II-1 in 2015.

The IGF Code is largely (prescriptively) based on the IMO's *International Code for the Construction and Equipment of Ships Carrying Liquefied Gases in Bulk* (IGC Code), itself developed from the experience with carrying LNG in bulk on gas carriers over the past 60 years or so. The original IGC Code only permitted the burning of natural gas (methane) cargoes as fuel to control the pressure and temperature of LNG cargo by consuming the boil-off gas from LNG stored in low pressure (atmospheric) bulk storage tanks.

The traditional propulsion configuration was LNG-powered steam turbines. Dual-fuel 4-stroke diesel engines arranged with electric drive emerged as the preferred arrangement from around 2005, while 2-stroke direct engines (in a twin skeg arrangement) emerged from around 2015.

#### Interim Fuel Cell Guidelines

MSC.1/Circ. 1647 *Interim guidelines for the safety of ships using fuel cell power installations* was approved in June 2022 to support the use of fuel cell power installations on board ships. The guidelines do not specifically address fuel handling but focus on the philosophy for onboard fuel cell arrangement, including protection of fuel cell spaces by dedicated spaces with independent ventilation and hazardous areas. Other provisions include fire and explosion protection, electrical systems and control and monitoring systems. While the interim guidelines for fuel cells applies to various types of fuel cells using either pure hydrogen or reforming other gas fuels, the general provisions and goal-based requirements are applicable and similar to the considerations for hydrogen-fuel systems.

During the finalisation of the IGF Code and the revised IGC Code, it was recognised that applying the IGF Code to gas carriers may create challenges. The codes were similar, but not the same, differing in some fundamental areas. Consequently, the IMO Maritime Safety Committee acknowledged that a policy decision was required.

This is detailed in paragraph 3.17 of MSC 95/22, indicating that IMO "... agreed that the IGF Code should not apply to ships subject to the IGC Code, even in the case of IGC Code ships using low-flashpoint fuels that are not cargo ...", effectively applying a 'one ship – one code' policy with respect to the application of the IGF and IGC Codes.

This policy decision was captured by implementing amendments to SOLAS to make the IGF Code mandatory. These amendments were adopted by IMO resolution MSC.392(95) in June 2015, which introduced a new Part G to SOLAS II-1, and with the 'one ship – one code' policy captured by the amendments to SOLAS II-1/56.4:

"This part shall not apply to gas carriers (as defined in regulation VII/11.2):

- .1 using their cargoes as fuel and complying with the requirements of the IGC Code (as defined in regulation VII/11.1); or

.2 using other low-flashpoint gaseous fuels provided that the fuel storage and distribution systems' design and arrangements for such gaseous fuels comply with the requirements of the IGC Code for gas as a cargo.”

### **IGC Code**

The original, IGC Code (1993) only permitted the burning of natural gas as a fuel by application of its Chapter 16. However, the adoption of the revised IGC Code by IMO Resolution MSC.370(93) in May 2014, which became effective 1 July 2016, introduced the option to burn other alternative cargoes under a new section 'Alternative fuels and technologies.' Notably this new provision excluded burning toxic cargoes.

The IGC Code does not include dedicated requirements for the carriage of hydrogen, although Resolution MSC.420(97) does cover interim recommendations for the carriage of liquefied hydrogen bulk, which specify the proposed selection of the general requirements and the special requirements, respectively, for liquefied hydrogen.

#### *Resolution MSC. 420(97)*

The Interim Recommendations for the carriage of liquefied hydrogen in bulk (MSC.420(97)) have been developed based on the results of a comparison study of similar cargoes listed in its Chapter 19. The application of general requirements in the IGC Code for liquefied hydrogen has been considered based on a comparison study on the physical properties of liquefied hydrogen and LNG. LNG and liquefied hydrogen are cryogenic liquids, non-toxic and generate flammable high-pressure gas.

The hazards of liquefied hydrogen to be considered were identified as low ignition energy, a wide range of flammability limits, low visibility of flames in case of fire, high flame velocity which may lead to detonation with shockwaves, low temperature and liquefaction/solidification of inert gas and constituents of air which may result in an oxygen-enriched atmosphere, high permeability, low viscosity and hydrogen embrittlement including weld metals.

Updates of this resolutions are expected to take place at a meeting of the IMO's Sub-Committee on Carriage of Cargoes and Containers (CCC) 9 scheduled for September 2023. A discussion on updating this circular was in the agenda of CCC 8, but due to time constraints this topic was not discussed.

#### *IMO Tank Types*

The IGC Code includes detailed material and design requirements for the containment of liquefied gases covering the basic tank types found on gas carriers, namely independent types A, B, C and dependent membrane types.

A comparison of the main characteristics and attributes for IMO fuel containment are shown below in Table 19. Types A, B and membrane tanks are low pressure, nominally 'atmospheric' tanks and Type C are designed using pressure vessel codes. The predominant technology used for LNG carrier (LNGC) fuel containment in the past 20 years have been the membrane and Type B Moss systems.

Type A, B and membrane tanks require a secondary barrier to protect against leaks from the primary barrier. Type A and membrane systems require a full secondary barrier. Type B tanks require a partial secondary barrier since they are designed using advanced fatigue-analysis tools and a 'leak-before-failure' concept, for which small leaks can be managed with partial cryogenic barrier protection and inert gas management in the inter-barrier space.

Type C tanks are designed with code criteria for pressure vessels and conservative stress limits, so they do not require a secondary barrier. They are also relatively cheap to fabricate but are not the most space-efficient designs.

Table 19. Main characteristics and attributes of IMO fuel containment systems

	Type A	Type B	Type C	Membrane
Tank Design	Independent Prismatic Structure calculated on classical ship structure design rules	Independent Prismatic or Spherical (Moss) Structure calculated on fatigue analysis and model tests – “leak before failure” concept	Independent Cylindrical or Spherical or Bi-Lobe or Tri-Lobe Pressure vessel design based on modified pressure vessel codes	Integrated Non-self-supporting, thin membrane supported through insulation by adjacent hull
Volume efficiency	Medium, inspection space	Medium, inspection space	Lowest (better with bi-lobe and tri-lobe)	Maximum
Max. Design Pressure	0.7 bar	0.7 bar (prismatic tanks)	>2 bar	0.7 bar
Secondary barrier	Full	Partial	None	Full
Inerting requirements	Inert inter-barrier (pressure & makeup)	Hold filled with dry air (standby inert capability)	Hold filled with inert gas or dry air	Inert inter-barrier (pressure & makeup)
Volume/weight ratio	Medium	Medium	Low	High
Theoretical BOR	Medium	Medium	High	Low
Sloshing effects	N/A	N/A	N/A	Reinforcements required
Inspection	Easy access, special test for secondary barrier	Easy access on both sides for inspection	Easy access (remote access on smaller tanks)	Special testing and inspection procedures

Independent tank type C is allocated only to dangerous goods of class 2.3, the vapour density of which is heavier than air. This type of tank is not thought to be required for liquefied hydrogen. Special environment controls such as drying and inerting are generally required for liquid chemical products in consideration of the reactivity of cargo vapours and the air. As is the case for LNG, it is not thought to be necessary to apply such requirements for liquefied hydrogen.

Figure 22 shows the saturated-vapour pressure curves for the main liquefied gases carried under the IGC Code and the potential for fully refrigerated, semi-refrigerated and fully pressurised storage.

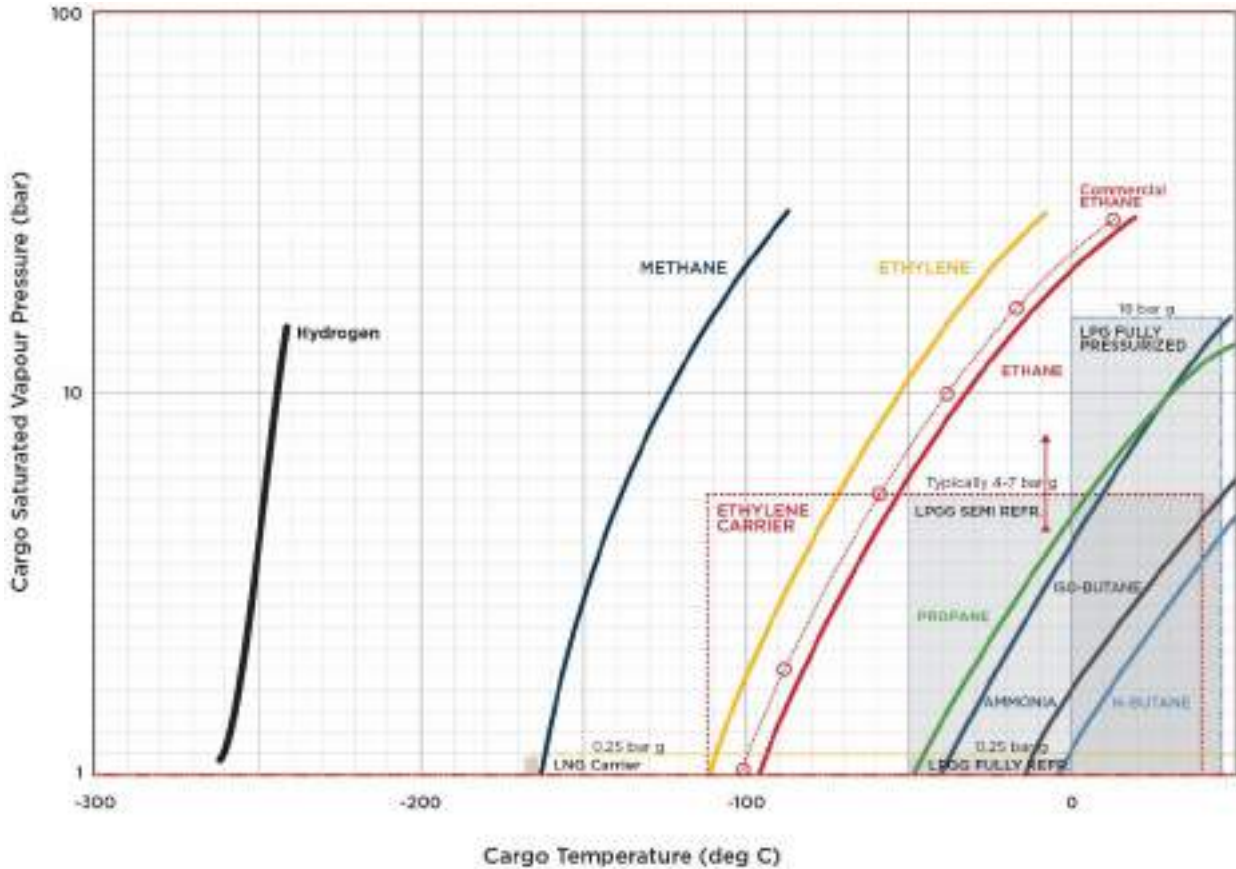

Figure 22. Typical operating range for Liquefied Gas Carriers

**Tank Materials**

The requirements for material specifications are included within the IGC Code (and the IGF Code), detailing chemical composition, mechanical properties, heat treatment, test requirements and the application of material with respect to minimum design temperatures of the product to be carried, see Table 20.

Table 20. Requirements for fuel tank material specifications

Minimum Design temperature (°C)	Chemical composition	Impact test temperature (°C)
-60	1.5% nickel steel – normalised or normalised and tempered or quenched and tempered or TMCP	-65
-65	2.25% nickel steel – normalised or normalised and tempered or quenched and tempered or TMCP	-70
-90	3.5% nickel steel – normalised or normalised and tempered or quenched and tempered or TMCP	-95
-105	5% nickel steel – normalised or normalised and tempered or quenched and tempered	-110
-165	9% nickel steel – double normalised and tempered or quenched and tempered	-196
-165	Austenitic steels, such as types 304, 304L, 316, 316L, 321 and 347-solution treated	-196
-165	Aluminium alloys, such as type 5083 annealed	Not required
-165	Austenitic Fe-Ni alloy (36% nickel). Heat treatment as agreed	Not required

LNG is meant to be carried in carbon steels with a 9% nickel content, austenitic steels, aluminium, or a specific Fe-Ni (Invar) alloy. Nickel steels containing more than 5% nickel are explicitly prohibited by IGC Code.

The general application of many of the IGC Code material requirements are applicable from -55°C to -165°C, so materials for carrying liquefied hydrogen at -253°C do not fall into this category. To increase technological innovation

in material development and in recognition that the experience usually required by the IMO before it adopts alternative materials in the IGC Code may not be available, for the past few years the organisation has been developing more guidelines under a CCC working group.

This work item was triggered by the introduction of High Manganese Austenitic Steels for cryogenic service on the bulk carrier *Ilshin Green Iris*<sup>17</sup>.

The output from this working group has included MSC.1/Circ.1599, the *Interim Guidelines on the Application of High Manganese Austenitic Steel for Cryogenic Service* (MCS.1/Circ.1599, 2019) and MSC.1/Circ.1622, *Guidelines for the Acceptance of Alternative Metallic Materials for Cryogenic Service in Ships Carrying Liquefied Gases in Bulk and Ships Using Gases or Other Low-Flashpoint Fuels* (MSC.1/Circ.1622, 2020). While both guidelines are currently undergoing updates and revisions, they indicate that tools are in place for the approval of alternative types of tank material under the IGC and IGF Codes.

### *Alternative Fuels and Technologies*

The provision to burn cargoes other than methane added in the 2016 IGC Code requires demonstrating the “same level of safety as natural gas”. However, to burn these fuels in gas carriers, there are different requirements from the flag Administrations on how to demonstrate that equivalency.

The provisions for ‘equivalents’ provided by 1.3 of the IGC Code allows for approval of equivalent arrangements (excluding operational methods) and requires approvals from flag Administrations to be communicated to the IMO. Those communications are available to all Administrations and other stakeholders through the IMO Global Integrated Shipping Information System (GISIS) database.

The approval under ‘equivalents’ paved a route to approval and recognition within the IGC Code, typically by applying a risk-based approval process incorporating HAZID (Hazard Identification), HAZOP (Hazard and Operability), etc. techniques to demonstrate that the “*same level of safety as natural gas*” has been achieved.

## **IGF Code**

### *General*

In June 2015, the IMO adopted the IGF Code with Resolution MSC.391(95) and adopted amendments to SOLAS to make the IGF Code mandatory, including a new Part G to SOLAS II-1, by IMO Resolution MSC.392(95).

Prior to this, the only guidance from the IMO for using natural gas as fuel was detailed in IMO Resolution MSC.285(86), the ‘*Interim Guidelines on Safety for Natural Gas-fuelled Engine Installations in Ships*’, which was adopted on 1 June 2009.

The adoption of the IGF Code introduced a framework and requirements under SOLAS for burning gases or other low-flashpoint fuels with a flashpoint less than 60°C.

### *Entry Into Force*

The IGF Code entered into force 1 January 2017 and was applicable to all ships, and ship conversions over 500GT, for which the building contract was placed on or after the same date. In the absence of a building contract, the IGF Code was made applicable to those ships with a keel laid on or after 1 July 2017, or which were delivered on or after 1 January 2021.

### *Structure*

The IGF Code is structured into Parts A, A-1, B-1, C-1 and D. Parts A and D are applicable to all gases and other low-flashpoint fuels, with the detailed prescriptive requirements for natural gas (methane) included under parts A-1, B-1 and C-1. In the longer term, it is understood that the IMO’s intent is to amend the IGF Code to include detailed prescriptive requirements for all the gases and low-flashpoint fuels used by the marine industry. While experience

---

<sup>17</sup> For more information on the service experience on this ship see CCC 7/4/1 and CCC 7/INF.7 from the Republic of Korea.



develops with these fuels, interim guidelines such as MSC.1/Circ.1621 (2020) *Interim Guidelines for the Safety of Ships Using Methyl/Ethyl Alcohol as Fuel* (2020) are expected to be developed.

Prior to the availability of these guidelines for other fuels, such as LPG, ammonia and hydrogen, the IGF Code can still be applied. This is outlined by the preamble to the IGF Code which states:

*“This Code addresses all areas that need special consideration for the usage of the low-flashpoint fuel. The basic philosophy of the IGF Code considers the goal-based approach (MSC.1/Circ.1394). Therefore, goals and functional requirements were specified for each section forming the basis for the design, construction and operation. The current version of this Code includes regulations to meet the functional requirements for natural gas fuel. Regulations for other low-flashpoint fuels will be added to this Code as, and when, they are developed by the Organization. In the meantime, for other low-flashpoint fuels, compliance with the functional requirements of this Code must be demonstrated through alternative design.”*

### Alternative Design

Applications for gases or low-flashpoint fuels other than methane need to apply the provisions from Part A, 2.3 of the IGF Code for ‘Alternative Design’ (see Table 21).

SOLAS regulation II-1/55 requires an engineering analysis to be submitted to the flag Administration, in accordance with the footnote reference to MSC.1/Circ.1212, *Guidelines on Alternative Design and Arrangements for SOLAS Chapters II-1 and III* (2006).

Once approved, the flag Administration will need to communicate this to the IMO’s GISIS database. This process follows a risk-based approach for approval of the design to ensure the goals and functional requirements of the IGF Code have been met.

The IMO’s MSC.1/Circ.1455, *Guidelines for the Approval of Alternatives and Equivalents as Provided in Various IMO Instruments* (2013), could offer a more appropriate framework for approval, subject to agreement by the flag Administration.

Table 21. Excerpts from IGF Code, Adoption of the International Code of Safety for Ships using Gases or Other Low-Flashpoint Fuels (MSC.391(95))

<b>2.3 Alternative Design</b>	
<b>2.3.1</b>	<i>This Code contains functional requirements for all appliances and arrangements related to the usage of low-flashpoint fuels.</i>
<b>2.3.2</b>	<i>Fuels, appliances and arrangements of low-flashpoint fuel systems may either: deviate from those set out in this Code, or be designed to use fuel not specifically addressed in this Code. Such fuels, appliances and arrangements can be used provided they meet the intent of the related goals and functional requirements and provide an equivalent level of safety of the relevant chapters.</i>
<b>2.3.3</b>	<i>The equivalence of the alternative design shall be demonstrated as specified in SOLAS Regulation II-1/55 and approved by the Administration. However, the Administration shall not allow the application of operational methods or procedures as an alternative to a particular fitting, material, appliance, apparatus, item of equipment, or type thereof which is prescribed by this Code.</i>
<b>4.2 Risk assessment</b>	
<b>4.2.1</b>	<i>A risk assessment shall be conducted to ensure that risks are addressed related to the use of low-flashpoint fuels that affect persons onboard, the environment, the structural strength or the integrity of the ship. Consideration</i>

	<i>shall be given to the hazards associated with physical layout, operation and maintenance, following any reasonably foreseeable failure.</i>
<b>4.2.3</b>	<i>The risks shall be analysed using acceptable and recognised risk-analysis techniques, and loss of function, component damage, fire, explosion and electric shock shall as a minimum be considered. The analysis shall ensure that risks are eliminated wherever possible. Risks which cannot be eliminated shall be mitigated as necessary. Details of risks, and how they are mitigated, shall be documented to the satisfaction of the Administration.</i>

Using hydrogen as a fuel brings some challenges because, unlike LNG, there is no gas carrier experience and few engines available for burning hydrogen. The first step would be to undertake a preliminary risk assessment (see Section 4 of this study for further information and case studies on related risk assessments). The IGF Code details the high-level objectives for risk assessments of gases or low-flashpoint fuels other than methane in sections 4.2.1 and 4.2.3 (see Table 21).

Further guidance on risk assessments under the IGF Code is provided in IACS Recommendation No.146 - *Risk Assessment as Required by the IGF Code* (see also subsection 3.2.7 for more information on IACS's efforts to support the application of the IGF Code).

#### *IMO IGF Code Workplan*

Since the IGF Code was adopted, the IMO has continued to support work on fuel cell requirements and other low-flashpoint fuels, such as methanol and LPG. The CCC has a permanent agenda item to cover this: '*Amendments to the IGF Code and development of guidelines for low-flashpoint fuels.*

This agenda already has produced amendments to the IGF Code to clarify and develop further the requirements for methane as fuel: e.g., MSC.422(98) adopted 15 June 2017; MSC.458(101) adopted 14 June 2019; and MSC.475(102) adopted 11 November 2020. It has also produced many 'unified interpretations', which were predominantly raised by IACS.

The IMO's interim guidelines for methyl/ethyl alcohol fuels (MSC.1/Circ.1621 *Interim Guidelines for the Safety of Ships Using Methyl/Ethyl Alcohol as Fuel*) also were developed under this agenda item and, the CCC 7 meeting in September 2021 completed the draft '*Interim Guidelines for the Safety of Ships using Fuel Cell Power Installations,*' which were approved at MSC 105 in June 2022.

The workload under this agenda item is heavy and will continue to be so for many years as more and more gases and low-flashpoint fuels enter the marine market. However, the work on considering how to develop IMO's requirements for hydrogen as fuel has started.

#### *Hydrogen Under the IGF Code?*

Submissions to the IMO proposed: that requirements for hydrogen and ammonia were needed urgently; that the fuels were separate contenders for zero- and low-carbon future fuels; and that the requirements could be developed in parallel. It has been recommended to add separate guidelines for hydrogen and ammonia to the terms of reference for the IGF Code work during CCC and in a correspondence group.

Therefore, developments of the interim guidelines for the safety of ships using hydrogen as fuel are ongoing and focus on compressed and liquid hydrogen, but do not focus on other technologies for storing hydrogen (i.e., hydride storage). The guidelines are to compliment MSC.1/Circ. 1647 *Interim guidelines for the safety of ships using fuel cell power installations*. The first draft of these interim guidelines has been adopted by MSC in 2022 with a plan to further develop and finalise them in due course.

With reference to subsection 3.2.7 below, a number of classification societies have introduced guidelines or tentative rules for hydrogen as fuel, many of which have adopted the format and structure of the IGF Code.

The goal and functional requirement-based structure of the IGF Code, together with a clear path to approving fuels not directly covered by the prescribed requirements using the ‘alternative-design’ process, illustrates that the Code has the right framework to approve all gases and low-flashpoint fuels.

Furthermore, the prescribed requirements developed for methane as a gas or stored as LNG, which are largely based on IGC Code requirements and experience, provide an easily adaptable set of design and safety concepts that are well suited to adoption by other gases or low-flashpoint fuels, once the specific fuel characteristics are accounted for.

The criteria for protective tank locations, cryogenic and pressurised fuel-containment and distribution requirements, the double-barrier concept for fuel-supply piping, the use of ventilation and gas-detection methods to detect leaks and mitigate them increasing to LEL (lower explosive limit) and the classification of hazardous areas, together with the requirements for training, PPE and operational measures, offer a strong set of safety concepts that are very transferrable to other gases.

### **Training - STCW**

Part D of the IGF Code, which covers all gases and low-flashpoint fuel applications for IGF Code ships under SOLAS, requires companies to ensure that the seafarers onboard these ships have completed the training that will give them the ability to fulfil their designated duties and responsibilities. This is applied through the IMO International Convention on Standards of Training, Certification and Watchkeeping for Seafarers (STCW).

When the SOLAS amendments were adopted for the IGF Code, the STCW Convention and Code was also amended (by MSC.396(95) and MSC.397(95)) to add specific training requirements and certification for IGF-Code seafarers.

Tables A-V/3-1 and A-V/3-2 of the STCW describe the requirements for competence, knowledge, understanding and proficiencies for basic and advanced training. The ‘basic training’ is for seafarers with “... *designated safety duties associated with the care, use or in emergency response to the fuel* ...”. ‘Advanced training’ is for “... *Masters, engineer officers and all personnel with immediate responsibility for the care and use of fuels and fuel systems on ships subject to the IGF Code* ...”.

To support application of hydrogen as fuel, member states should develop national training and certification suitable for certification to the STCW Convention.

### **ISM Code**

The IMO *International Safety Management Code* (ISM Code) provides an international standard for the safe management and operation of ships and prevent pollution. Intended to have a widespread application, based on general principles and objectives, this Code requires operators to assess all risks to a specific company’s ships, personnel and the environment, and to establish appropriate safeguards.

Notwithstanding the final decision on the application of hydrogen as fuel under the IGF Code, there is a connection, or applicable analogy, to the operational requirements in place under the IGF Code Part C-1 for methane.

Under Section 17, it is required that drills and emergency exercises be conducted onboard at regular intervals. Section 18 includes operational requirements, including the requirement for a fuel-handling manual and the provision of emergency procedures. The fuel-handling manual must cover the overall operation of the ship from dry-dock to dry-dock, including firefighting and emergency procedures, specific fuel properties and the equipment needed to safely handle specific fuel, etc.

The responsibility to produce these manuals initially falls to the shipyard, or designer and equipment suppliers. But it also makes some functions mandatory for the operators.

These IGF Code requirements provide the supporting documents and basis for operators to undertake their ISM Code obligations. It is recommended that -- regardless of the IMO’s final decisions on the appropriate instrumentation for hydrogen as a marine fuel -- applicable regulations, guidelines, or amendments to the IGF Code or newly developed instruments adopt the same framework of operational requirements as those for methane by Part C-1 of the IGF Code. This will facilitate application under the ISM Code.

### 3.2.2.2 MARPOL

MARPOL sets out the international requirements for preventing pollution from ships travelling internationally or between two member states. The Convention is divided into annexes covering specific pollution controls:

- Annex I – Regulations for the prevention of pollution by oil
- Annex II – Regulations for the control of noxious liquid substances in bulk
- Annex III – Regulations for prevention of pollution by harmful substances carried by sea in packaged form
- Annex IV – Regulations for the prevention of pollution by sewage from ships
- Annex V – Regulations for the prevention of pollution by garbage from ships

The last annex added to the Convention, Annex VI – Regulations for the prevention of air pollution from ships – was adopted by the Protocol of 1997 to MARPOL. It introduced the IMO's regulatory framework for air pollution and key air-pollutant controls for shipping, including for ozone-depleting substances, NO<sub>x</sub>, SO<sub>x</sub>, Volatile Organic Compounds (VOCs), shipboard incineration and the availability and quality of fuel oils. By later amendment, the IMO introduced regulations covering energy efficiency.

Four key regulations in MARPOL Annex VI are important when considering hydrogen as a marine fuel.

#### **Air Pollution Annex VI, Regulation 13 – Nitrogen Oxides (NO<sub>x</sub>)**

To reduce the harmful effects of NO<sub>x</sub> emissions on human health and the environment, Regulation 13 detailed the limits for emissions from ship's diesel engines. It mandates that all marine diesel engines greater than 130 kW installed on vessels subject to MARPOL Annex VI are to comply with the applicable emission limit, except engines that are only used for emergency applications.

Marine diesel engines are defined by the IMO as any reciprocating internal combustion engine operating on liquid, gaseous or dual fuels, including those operating on the Diesel or Otto combustion cycles.

This regulation's NO<sub>x</sub> limits are based on engine-rated speed (see

Figure 23), with the lowest limits applicable to medium and high-speed engines. The application date of Regulation 13's NO<sub>x</sub> limits is tied to the ship's construction date.

When Annex VI entered into force on 19 May 2005, the Tier I NO<sub>x</sub> limit was retrospectively applicable to engines fitted to ships with keels laid on or after 1 January 2000. Additional NO<sub>x</sub> limits were introduced by amendments to 2008 Annex VI and the NO<sub>x</sub> Technical Code (NTC), including the global Tier II limit from 1 January 2011.

They also introduced the Tier III limit, which is only applicable in Emission Control Areas (ECA), which effectively represented a NO<sub>x</sub> reduction of about 80% from the previous Tier I limit.

The Tier III limits are applicable to NO<sub>x</sub> ECAs once these areas are officially recognised by the IMO. Currently, the only NO<sub>x</sub> ECAs in force are the North American and United States Caribbean Sea areas, which entered into force on 1 January 2016, and the Baltic and North Sea ECAs (originally designated as SO<sub>x</sub> ECAs only), which became NO<sub>x</sub> ECAs from 1 January 2021.

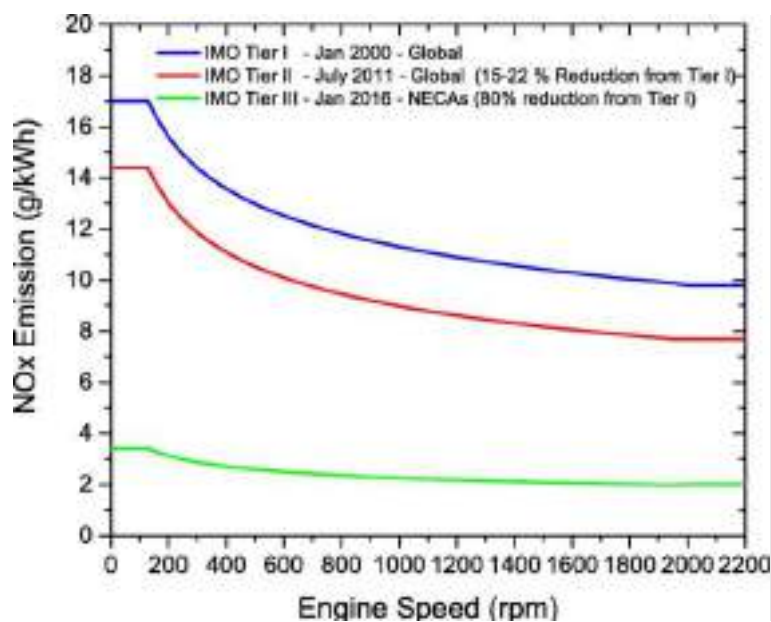

Figure 23. MARPOL 73/78 Annex VI Reg 13 – NOx emission limits with respect to engine speed

The key instrument supporting Regulation 13's regulations is the NTC (National Transport Commission), which is in large part based on the ISO 8178 series of standards "*Reciprocating internal combustion engines – exhaust emission measurement*", in particular the following parts (showing current revision dates):

- ISO 8178-1:2020 Part 1: Test-bed measurement systems of gaseous and particulate emissions
- ISO 8178-4:2020 Part 4: Steady state and transient test cycles for different engine applications
- ISO 8178-5:2021 Part 5: Test fuels
- ISO 8178-6:2018 Part 6: Report of measuring results and test
- ISO 8178-7:2015 Part 7: Engine family determination
- ISO 8178-8:2015 Part 8: Engine group determination

As required by Annex VI, the NTC is to be applied for the reference testing and certification of all marine diesel engines subject to the requirements of Regulation 13. The NTC sets the application-specific test cycles from which the cycle-weighted NOx emission value for that specific group or family of engines (as represented by the parent engine testing) is determined, in accordance with the provisions of the NTC's chapter 5.

As part of those provisions, the NTC requires that the parent-engine test is undertaken on a DM grade (distillate) marine fuel in accordance with ISO 8217:2005, if a suitable reference fuel is not available.

Furthermore, if a DM grade is not available, the emissions testing for the parent engine is to be undertaken on a RM grade (residual) fuel oil. In all cases, the fuel oil used during the test is sampled and analysed for use in the calculation of the NOx emissions. Most certifications for marine NOx emissions have been undertaken on a DM grade fuel oil.

Marine engines, particularly the larger medium- and slow-speed engines, can operate on a wide range of ISO 8217 distillate and residual fuel oils and have adjustable features to compensate for variations in fuel quality and ignition properties. This is the basis of engine group (rather than engine family) certification and these ranges of operation are covered in the technical files of engine-group and individual engine certifications.

While the range of marine fuel oils varies significantly, including fuel-bound nitrogen and oxygen content, the IMO's NOx-certification regime is based on defined test-bed testing using DM- or RM-grade fuels and it accepts that NOx emissions in operation will vary from the certified values, depending on the fuel oil.

This recognition is confirmed by the allowance of 10% NOx emissions for onboard tests using RM grade fuel oils (refer to 6.3.11.2 of the NTC). This foundation is applied from a knowledge base of RM and DM grade fuel oils and blends derived from petroleum refining.

For the testing and certification of DF engines, Annex VI and the NTC has been consistently updated to add fuel-specific emissions factors and other items missing from the original 1997 documents and 2008 amendments, which covered marine fuels used and anticipated at the time. The latest amendments are detailed in MEPC.251(66) (2014), MEPC.258(67) (2014) and MEPC.272(69) (2016), adding to the requirements for petroleum-derived conventional fuel oils and to include more information on using the following fuels:

- Rapeseed Methyl Ester
- Methanol
- Ethanol
- Natural Gas
- Propane
- Butane

The amendments to update the NO<sub>x</sub>-certification requirements under Annex VI and the NTC to include requirements for testing hydrogen are outstanding and remain a hurdle to implementation. The vast majority of NO<sub>x</sub> certification is based on determining the flow of exhaust masses by applying the carbon-balance method to the fuel characteristics.

Currently, hydrogen falls under the Annex VI definition of “fuel oil”, which includes “... any fuel delivered to and intended for combustion purposes for propulsion or operation onboard a ship, including *gas*, distillate and residual fuels”. This needs to be considered during the development of the IMO instruments for application of hydrogen as a marine fuel.

#### **Air Pollution Annex VI, Regulation 14 – Sulphur Oxides (SO<sub>x</sub>) and Particulate Matter (PM)**

By limiting the sulphur content of marine fuels, MARPOL Annex VI Regulation 14 restricts the volume of SO<sub>x</sub>, and the sulphate-based particulate matter (PM) emitted from fuel oil-consuming equipment onboard ships.

Similar to the Regulation 13 limits for NO<sub>x</sub>, the IMO adopted sulphur-content limits for fuels that were later updated with the 2008 revisions to Annex VI and allowed different limits for sulphur content to be applied globally and locally within ECAs.

Starting with limits of 4.5% sulphur globally and 1.5% in ECAs, those limits have been progressively reduced, with the ECA limit reduced to 0.1% from 1 January 2015 and the global limit reduced to 0.5 from 1 January 2020 – see Figure 24.

At present, there are no IMO initiatives to further reduce these limits to align them with those imposed on the use of diesel on roads, which are significantly below the IMO global limits of 5,000 ppm and 1,000 ppm in ECAs.

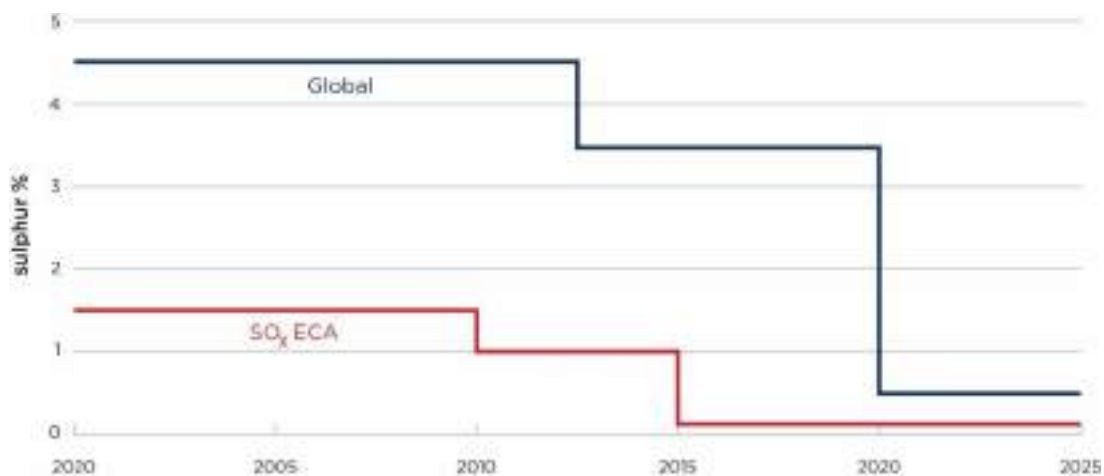

Figure 24. MARPOL 73/78 Annex VI Reg 14 – SO<sub>x</sub> emission limits

Hydrogen is sulphur free and therefore provides a way to comply with, and go well beyond, the requirements of Regulation 14. It is expected that the dual-fuel (DF) hydrogen engines will use sulphur-compliant pilot fuels and, depending on the engine technology, this may represent a significant proportion of the fuel consumed (possibly as much as 15-20%, but this is still under development).

It is perhaps unlikely but applying the 'Equivalents' found in Regulation 4 may show the way to using high-sulphur pilot fuels in DF hydrogen engines. Some precedents exist for this on LNG carriers that burn high-sulphur pilot fuels with LNG boil-off gas; these have been recognised for application to the EU Sulphur Directive 1999/32/EC, as amended -- and codified by EU Directive 2016/802 -- and by the EU Regulation 2010/769/EU of 13 December 2010.

### **Air Pollution, Annex VI Regulation 18 – Fuel Oil Availability and Quality**

Regulation 18 to MARPOL Annex VI sets the requirements for Administrations, fuel suppliers and owner/operators for the availability and quality of fuel oil. As defined by Annex VI, fuel oil means "any fuel delivered to and intended for combustion purposes for propulsion or operation onboard a ship, including gas, distillate, and residual fuels".

These requirements oblige the fuel supplier to document the fuel-sulphur content (and other parameters) within the Bunker Delivery Note (BDN), and for the BDN to be accompanied with a sealed sample of the fuel, known as the 'MARPOL sample'.

However, Regulation 18.4 clarifies that the BDN and fuel sample requirements do not apply to gaseous fuels such as LNG, CNG or LPG. Similar exemptions also may be considered applicable to hydrogen. This is another area of amendment to Annex VI and the NTC that needs to be captured during the development of the IMO instruments for using hydrogen as a marine fuel, as NO<sub>x</sub> emissions are expected from using hydrogen in internal combustion engines.

Regulation 18.3 lists the general fuel properties required for hydrocarbon fuel oils derived largely from petroleum refining and fuel oil for combustion purposes derived by methods other than petroleum refining. Hydrogen will fall into the latter category. However, many of the high-level fuel requirements are applicable to fuels derived from both methods. These requirements state that the fuels should not:

- Contain inorganic acid
- Jeopardise the safety of ships or adversely affect the performance of machinery
- Harm or be harmful to personnel
- Contribute overall to additional air pollution

The requirement under Regulation 18.3.2.2 requires that fuels derived by methods other than petroleum refining should not cause an engine to exceed the applicable NO<sub>x</sub> emission limits. This requirement is particularly challenging to deal with since Regulation 18 largely tackles obligations on fuel suppliers, who have no means of verifying it without the support of the owner/operators and engine designers.

Regarding the legal obligations on documenting the fuel-sulphur content and the BDN, for safety reasons it is recommended that the process for sampling, testing and verifying the hydrogen characteristics is agreed with the fuel supplier and flag Administration prior to bunkering of hydrogen as a fuel.

Documenting fuel properties, commercial aspects and verifying statutory sulphur compliance would need to be agreed with the fuel supplier.

### **Air Pollution Annex VI, Chapter 4 – Regulations on energy efficiency for ships**

The Energy Efficiency Design Index (EEDI) was made mandatory for new ships at MEPC 62 (July 2011) with the adoption of amendments to MARPOL Annex VI (resolution MEPC.203(62)) by parties to MARPOL Annex VI. The EEDI baselines were constructed using ships built between 1999 and 2008, assuming the use of heavy fuel oil (HFO) and a tank-to-wake carbon factor of 3.114.

Accompanying guidelines for the calculation of the attained EEDI levels were developed and periodically updated. These calculation guidelines are listed in Table 22, which contains tank-to-wake carbon factors for different types of fuels.

Table 22. Tank-to-Wake Carbon Factors for different types of fuels (MEPC.364(79))

Type of Fuel	Reference	Lower Calorific Value (LCV)	Carbon Content	C <sub>f</sub> (t-CO <sub>2</sub> /t-Fuel)
Diesel/Gas Oil	ISO 8217 Grades DMX through DMB	42,700	0.8744	3.206
Light Fuel Oil	ISO 8217 Grades RMA through RMD	41,200	0.8594	3.151
Heavy Fuel Oil	ISO 8217 Grades RME through RMK	40,200	0.8493	3.114
Liquified Petroleum Gas	Propane	46,300	0.8182	3.000
	Butane	45,700	0.8264	3.030
Ethane	-	46,400	0.7989	2.927
Liquified Natural Gas	-	48,000	0.7500	2.750
Methanol	-	19,900	0.3750	1.375
Ethanol	-	26,800	0.5217	1.913

As can be seen above, there is no provision for hydrogen, which could be assigned a tank-to-wake carbon factor (C<sub>F</sub>) of 0. A ship capable of operating primarily on hydrogen (allowing for pilot fuel or hybrid fuel cell arrangements) could be assigned such a low EEDI level as to render it effectively exempt from the regulation.

There have been some initial calls for the EEDI framework to be converted into a pure energy-efficiency metric without the influence of carbon factors. This action would eliminate the need for more additions to this table.

However, there are other IMO regulations that refer back to this table in the EEDI Calculation Guidelines. The first is the energy efficiency framework for existing ships (EEXI) that was agreed at MEPC 76, which broadly applies the EEDI concept to existing rather than new ships; there are, however, some adaptations to the framework that recognise the difficulty in obtaining documentation, and the potential for existing ships to meet the standards designed for new ships.

Since it is unlikely to be possible to retrofit hydrogen engines and fuel-handling systems by the deadline for EEXI compliance, the absence of hydrogen from the table is not likely to have any bearing on initial EEXI compliance.

The IMO Fuel Oil Consumption Database also refers to the carbon factors provided in the EEDI Calculation Guidelines and, to ensure consistent reporting, a table entry for the carbon factors of hydrogen may be needed.

Additionally, the regulations from the IMO's Carbon Intensity Indicator (CII), which entered force in 2023, are built from the organisation's Fuel Oil Consumption Database and, by extension, this table of carbon factors will be used to calculate the CII levels attained. An example of the impact of hydrogen in CII is shown in Appendix II – Impact of H<sub>2</sub> Auxiliary Engines and Fuel Cells in CII for a very large container ship (23k TEU) and for a 174k LNG carrier. This was compared to the same vessels with one of the auxiliary engines replaced with a Hydrogen-fuelled auxiliary engine (container ship) or with a Hydrogen generating system and fuel cell (LNG carrier).

The lifecycle GHG and Carbon Intensity Guidelines for Marine Fuels are also being developed and will be used to derive well-to-wake carbon factors for fuels. Hydrogen may be assigned a range of different carbon factors, depending on the production pathway. MEPC 80 adopted Resolution MEPC.376(80), which contains the initial work of the Correspondence Group on Marine Fuel Life Cycle GHG Guidelines (LCA Guidelines), including carbon dioxide, methane and nitrous oxide emissions. The potential use of well-to-wake carbon factors in the existing measures, such as EEDI, EEXI and CII has been discussed. However, their inclusion remains uncertain. In the meantime, an Interim Guidance (MEPC.1/Circ.905) has been adopted for the use of certified biofuels in CII and DCS.

Another very important outcome of the MEPC 80 (Resolution MEPC.377(80)) is the 2023 IMO Strategy on Reduction of GHG Emissions from Ships, which increases the levels of ambition compared to the Initial 2018 Strategy. The level of ambitions has been agreed as follows:

1. *carbon intensity of the ship to decline through further improvement of the energy efficiency for new ships: to review with the aim of strengthening the energy efficiency design requirements for ships;*



2. *carbon intensity of international shipping to decline: to reduce CO<sub>2</sub> emissions per transport work, as an average across international shipping, by at least 40% by 2030, compared to 2008;*
3. *uptake of zero or near-zero GHG emission technologies, fuels and/or energy sources to increase: uptake of zero or near-zero GHG emission technologies, fuels and/or energy sources to represent at least 5%, striving for 10%, of the energy used by international shipping by 2030; and*
4. *GHG emissions from international shipping to reach net zero: to peak GHG emissions from international shipping as soon as possible and to reach net-zero GHG emissions by or around, i.e., close to, 2050, considering different national circumstances whilst pursuing efforts towards phasing them out as called for in the Vision consistent with the long-term temperature goal set out in Article 2 of the Paris Agreement.*

To achieve the above and most importantly the two last ones, the IMO is expected to evaluate candidate mid-term measures which will be decided and enter into force the earliest in 2027. These will include a technical measure, i.e., a goal based marine fuel standard regulating the reduction of the GHG intensity of fuels (which is expected to follow a similar concept to FuelEU) and an economic measure, i.e., a GHG emission pricing mechanism. Regarding the exact framework to be implemented for the latter, there are divergent views and proposals. Both the technical and economic measures should consider the well-to-wake emissions of fuels as per the LCA Guidelines. These developments are expected to encourage the update of alternative fuels with low GHG emissions.

### 3.2.3 International Bunker Industry Association

The International Bunker Industry Association (IBIA) is based in the United Kingdom, with branches in Africa and Asia, representing industry stakeholders. Its membership is broad and includes participants from sectors such as: owner/operators; bunker suppliers; traders; brokers; and port authorities. The IBIA has consultative status at the IMO as a non-governmental organisation and is an important and active player in providing technical information to the IMO on marine-fuel specifications, fuel sampling, etc.

The IBIA develops positions on IMO regulations and industry guidance or best practice publications, both directly and as contributors. The joint industry guidance document '*The supply and use of 0.50% sulphur marine fuel*' is an example (OCIMF, 2019).

To support the industry's adoption of alternative marine bunker fuels, the IBIA has created the Future Fuels Working Group, which has been assessing the associated technologies and fuels, including hydrogen.

As soon as the results of this ongoing assessment are finalised, they will be available to IBIA members<sup>18</sup>.

### 3.2.4 The Society of International Tanker and Terminal Owners (SIGTTO)

The Society of International Tanker and Terminal Owners (SIGTTO) is an international body established for the exchange of technical information and experience between members. SIGTTO has been instrumental in the development of the IGC Code. With a membership encompassing ship owners/operators and terminal operators, it also provides the most competent source of experience on cargo loading and unloading, and the ship-to-ship transfers of liquefied gases.

The society produces position papers, standards, guidelines and recommendations applicable to gas carriers, solely and in association with other industry stakeholders such as OCIMF on common subjects. As with LNG-bunkering ships, the IGC Code would be applicable to hydrogen-bunkering ships which are subject to the SOLAS convention, and also to the ships typically required by flag Administrations for bunkering vessels or barges operating solely in their sovereign waters.

Some of the most relevant publications are detailed below for reference. At present, it is understood that SIGTTO is not developing specific publications for hydrogen, but it could. As can be seen from the existing IGC Code

---

<sup>18</sup> <https://ibia.net/2022/03/04/ibia-future-fuels-working-group-assessment/>

requirements and the additional publications in this space, such as those identified below, everything for the carriage of hydrogen in bulk, cargo loading/unloading, ship-to-ship transfers, etc., is already covered. It is more likely that the Society for Gas as a Marine Fuel – see subsection 3.2.5 below – and the ISO will develop standards and industry guidance to support the bunkering of hydrogen.

**ESD Systems – Recommendations for Emergency Shutdown and Related Safety Systems** (second edition published 2021). This document provides recommendations for emergency shutdown (ESD) and related safety systems, including overflow control, ship/shore link and emergency-release systems. Guidance for testing these systems is provided and ‘bowtie diagrams’ are used to help explain the IGC Code requirements. In addition to discussing the requirements of the IGC Code, this document recommends additional measures for linked ESD systems for LPG. An overview of the types of ship-to-shore systems that are typically used in the industry is provided in the annexes, including guidance for cyber security issues associated with linked ESD systems.

**Recommendations for Relief Valves on Gas Carriers.** The third edition was published 2020. Relief valves perform a safety-critical function, so proper design and robust maintenance procedures are essential to ensure that this equipment will function as required. The purpose of this document is to provide information to support this goal.

**Ship/Shore Interface for LPG/Chemical Gas Carriers and Terminals.** The first edition was published 2018. This publication identifies potential hazards at the LPG/chemical ship/shore interface. Referencing industry regulations and guidance, it suggests best working practices for the terminal and the ship to minimise the risk of incident and to help raise overall safety awareness. This publication describes risk-assessment and hazard-identification techniques that can be applied by LPG/chemical gas shipping staff and terminal operators. It identifies the principal risks at the ship/shore interface, including vessel arrival and departure, loading and discharge operations, gas detection and exposure to hazardous products. Diagrams support the text and effectively illustrate how to mitigate ‘top event’ hazards to cargo containment.

**Guidelines for the Alleviation of Excessive Surge Pressures on ESD for Liquefied Gas Transfer Systems.** The second edition was published 2018. This publication explains the concept of surge pressure and provides practical advice on the associated hazards and risk management. It outlines the principal design and operational recommendations for cargo-transfer systems and will benefit the managers, designers and operators of liquefied gas carriers.

**Recommendations for Liquefied Gas Carrier Manifolds.** The second edition was published 2018. This publication provides recommendations on the layout, strength and fittings for gas-carrier manifolds and is applicable to LPG and LNG carriers. The aim of this publication is to improve standardisation of LPG and LNG carrier manifolds to assist in the safe connection of cargo-transfer equipment at every facility. Guidance is also provided on the containment of cargo spills, including deck protection, coaming, drip trays, gratings, drainage and water curtains.

**Liquefied Gas Handling Principles on Ships and in Terminals, (LGHP4).** The fourth edition was published 2016. This publication covers every aspect of the safe handling of bulk liquid gases (LNG, LPG and chemical gases) onboard ships and at the ship/shore interfaces. It emphasises the importance of understanding the physical properties of gases in relation to the practical operation of gas-handling equipment on ships and at terminals.

**Ship-to-Ship (STS) Transfer Guide for Petroleum, Chemicals and Liquefied Gases (CDI, ICS, OCIMF and SIGTTO).** The first Edition was published 2013. This cross-industry publication provides guidance on planning and execution of STS operations. It is applicable to all ships involved in transfer activities and to all types of bulk liquid cargoes, whether transferred at sea or in port. It will benefit Masters, Marine Superintendents and others, such as STS service providers and transfer organisers, involved in STS operations.

**Liquefied Petroleum Gas Sampling Procedures.** The first Edition was published 2010. This publication is a comprehensive guide to sampling liquefied petroleum gas. It covers the whole process and looks at the basic reasons for taking cargo samples, sampling connections, e.g., open- and closed-loop systems, the types of sample containers, recommended standard sample connections and safe procedures for taking samples.

### 3.2.5 Society for Gas as a Marine Fuel (SGMF)

The Society for Gas as a Marine Fuel was established in 2013 from a SIGTTO-driven initiative. It is a non-governmental organisation (NGO) established to promote safety and industry best practice for using gas as a marine fuel. It obtained NGO status at the IMO in 2019.

Most of the SGMF's activities, focus and publications have been on LNG as the marine 'gas' fuel. However, its scope is likely to expand to include other gases being considered for marine fuels, notably hydrogen and ammonia.

The SGMF has developed a tool called 'BASiL' (Bunkering Area Safety information LNG) to support the processes related to bunkering interfaces, port permitting and establishing the safety and zones referenced in the ISO standard subsection of this study. Expanding this tool, or developing new ones, to support other fuels of interest is a work in progress and would support the adoption of hydrogen as a marine fuel.

The list of publications for LNG from SGMF are for reference below; they are helpful documents, which also illustrate the current gaps in industry guidance and best-practice for using hydrogen as a marine fuel. Industry would benefit from these publications being updated to cover a wider range of liquefied gases or developing hydrogen-specific guidance.

**FP00-01-06 Ver4.0 LNG as a marine fuel: An Introductory Guide; June 2021.** This high-level publication sets out the key facts about LNG: what it is, how it is used, its environmental and safety profile, which countries have invested in it, ship design and systems, bunkering facilities, and process, how it is purchased, and how the personnel involved in handling LNG should be trained and familiarised.

**FP02-01 Ver1.0 Gas as a marine fuel: Recommendation of Controlled Zones during LNG bunkering; May 2018.** This publication details how to effectively determine the location and size of 'controlled zones' around bunkering equipment.

**FP05-01 Ver1.0 Gas as a marine fuel: contractual guidelines; September 2015.** This publication provides an overview of the process to transfer the custody of LNG to marine vessels. It describes the variables to be measured for the main marine engine types, and the proven techniques for measuring LNG quantity and quality. The guide describes several methods, all of which provide accuracy and auditability to support the custody-transfer process.

**FP07-01 Ver3.0 LNG as a marine fuel: Safety and Operational Guidelines - Bunkering; December 2021.** This covers recommendations from design stages of vessels and bunkering facilities through to the planning and preparation stages of bunkering locations and vessel operations for all stakeholders in the bunkering process.

**FP08-01 Ver1.0 Gas as a marine fuel: Simultaneous Operations during LNG bunkering; May 2018.** This publication looks at undertaking typical ship operations in port while simultaneously transferring fuel (SIMOPS). It is imperative not to compromise safety when using LNG, but it is also important to support other operations that promote, and in some cases improve, operational efficiencies while at ports. This publication looks at the issues and clearly describes the process of managing the associated risks.

**FP10-01 Ver1.0 Gas as a marine fuel: Work practices for maintenance, repair and dry-dock operations; May 2020.** This document provides new guidance on the work practices for maintenance, repair and dry-dock operations for ships that use gas/LNG as fuel. It seeks to ensure safe maintenance practices for gas-fuelled ships.

**FP14-01 Ver1.0 Gas as a marine fuel: Operations of ships with Liquefied Natural Gas (LNG) competency and assessment guidelines; May 2021.** This document focuses on all activities related to the preparation, storage, handling and use of gas as a fuel -- from the storage tank through to delivery to the consumer. It also highlights the competencies required for the personnel who perform related tasks.

**TGN06-04 Ver1.0 Gas as a marine fuel: manifold arrangements for gas-fuelled vessels; May 2019.** This document is intended to focus discussion and industry alignment on the manifold arrangements fitted onboard gas-fuelled vessels.

**TGN06-05 Ver1.0 Gas as a marine fuel: recommendations for linked emergency-shutdown arrangements for LNG Bunkering; May 2019.** This technical guidance note (TGN) provides recommendations for the (ESD arrangements, integration, data and voice communication and their interfaces for LNG bunkering of gas-fuelled ships.

It specifically addresses the functional safety principles of the linked ESD system to ensure a controlled shutdown of bunkering operations during emergencies.

**TGN06-06 Ver1.0 Gas as a marine fuel: LNG bunkering with hose bunker systems: considerations and recommendations; February 2020.** This TGN provides recommendations for the safe handling and operation of bunker systems using cryogenic flexible hoses as the main means to transfer LNG. It specifically addresses the selection of the hoses, their handling and functional safety principles.

**TGN06-07 Ver1.0 Gas as a marine fuel: Bunker Station Location: Considerations and Recommendations; January 2021.** This TGN addresses the industry requirements for guidelines for locating the bunkering manifolds and/or bunker stations installed on gas-fuelled vessels subject to the IGF Code.

The EMSA study “*Guidance on LNG Bunkering to Port Authorities and Administrations*”, published in January 2018, is another guidance document that could be updated to include hydrogen.

### 3.2.6 International Electrotechnical Commission

Established in 1906, this international non-profit organisation develops standards in the field of electric and electrotechnical components and systems.

To prepare international standards regarding fuel cell technologies for all fuel cell types and associated applications such as stationary fuel cell power systems for distributed power generators and combined heat and power systems, fuel cells for transportation such as propulsion systems, range extenders, auxiliary power units, portable fuel cells power systems, micro-fuel cell power systems, reverse operating fuel cells power systems and general electrochemical flow systems and processes.

**IEC/TC 105.** IEC Technical Committee 105 focuses on developing standards intended to cover the market demand for:

- Component, sub-system and fuel cell suppliers
- Fuel cell and system installers
- Fuel cell and system manufacturers
- Testing and certification bodies
- Regulators, authorities, approval organisations
- Original equipment manufacturers (OEM)

All IEC information and standards published for fuel cells technologies do not directly apply but they can be referenced when considering applications for marine use.

### 3.2.7 Society of Automotive Engineers International (SAE)

Originally organised in the U.S. to standardise vehicle-engineering practices, the Society of Automotive Engineers is recognised globally as a centre for automotive standards and related engineering practices. Various committees within the SAE meet to discuss new technology standards and best practices, including the Fuel Cell Standards Committee within the Motor Vehicle Council. Several standards within this committee relate to hydrogen as a vehicle fuel, including fuel cell testing, fuelling protocols and fuel quality standards. These may not directly apply to marine applications but may be referenced in marine standards. A sample list of relevant standards from this Committee is provided:

- SAE 2579\_201806 Standard for Fuel Systems in Fuel Cell and Other Hydrogen Vehicles
- SAE J2601/2\_201409 Fuelling Protocol for Gaseous Hydrogen-Powered Heavy Duty Vehicles
- SAE J2719\_202003 Hydrogen Fuel Quality for Fuel Cell Vehicles
- SAE J3219\_202206 Hydrogen Fuel Quality Screening Test of Chemicals for Fuel Cell Vehicles

### 3.2.8 International Council on Combustion Engines (CIMAC)

#### *Gas Engines Working Group – WG17*

The CIMAC WG17 Guideline on Hydrogen in Stationary 4-Stroke Gas Engines for Power Generation (2021) provides information on engine operations, controls and hardware when operating on hydrogen/natural gas blends or pure hydrogen fuel. Discussion includes impacts on engine performance with various blends, changes considered for engine hardware and fuel-supply systems, material considerations, lubrication needs, engine controls and other safety considerations. Quality is discussed in the paper regarding natural gas, rather than quality of hydrogen fuel supply before blending (CIMAC, 2021).

Members of CIMAC include global providers of marine engines and systems, who also provide the publicly available OEM guidance and information on the application of all conventional or alternative gaseous and liquid fuels, including hydrogen and its derivative fuels.

### 3.2.9 International Association of Classification Societies (IACS)

Classification societies play an active maritime role in assuring the safety of life, property and the environment. The members of IACS collectively make a unique contribution to maritime safety and regulation by providing technical support, compliance verification (of statutory instruments in their role as Recognised Organisations) and research and development. The collaborative effort of the multiple class societies in IACS leads to the implementation of common rules, unified requirements (UR) for typical Class Rules, unified interpretations (UI) of statutory instruments and other recommendations that are applied consistently by IACS members.

As indicated above, the IGF Code appears to be the most appropriate IMO instrument to deal with hydrogen as a fuel until the organisation develops non-mandatory guidelines or amends SOLAS instruments to cover its application. The goal and functional requirement-based structure of the IGF Code, together with the clear path to approval of fuels not directly covered by the requirements through the 'alternative-design' process, means the IGF Code has the right framework for approving all gases and low-flashpoint fuels.

Furthermore, IACS has been active in developing URs, UIs and recommendations to support application of the IGF Code, many of which are transferrable to hydrogen, or other gases or low-flashpoint fuels. It would benefit the marine adoption of hydrogen and other fuels if IACS updated these documents to cover a broader range of fuels than just LNG. Until then, applying the intent and principles of these documents will be necessary. A representative list of relevant IACS URs and recommendations are provided in Table 23 and Table 24.

All IACS publications are publicly available on their website: <https://www.iacs.org.uk/publications/>

#### **For Onboard Power Production**

All internationally trading ships subject to SOLAS need to comply with its requirements for machinery arrangements. Chapter II-1 of SOLAS (Construction – structure, stability, installations) includes requirements for machinery installations under Part C, specifically for machinery including internal combustion engines under regulation 27.

Part D includes the requirements for electrical installations; Part F holds the IMO criteria for alternative design and arrangements.

Chapter II-2 of SOLAS (Construction – Fire protection, fire detection and fire extinction) has additional requirements for machinery spaces.

These high-level mandatory safety requirements, together with the SOLAS-driven requirements of the IGF Code, comprise the primary regulatory safety rules for onboard propulsion and power generation for ships using gases or other low-flashpoint fuels.

For fuel cell applications, IMO's *'Interim Guidelines for the Safety of Ships using Fuel Cell Power Installations'*, which were approved at MSC 105 in June 2022, are applicable, subject to agreement from the flag Administration.

Supporting the IMO requirements are the extensive requirements for internal combustion engines and machinery from the classification societies. Many IACS URs are applicable and class societies have incorporated them into their respective rules and collectively applied them in a harmonised manner. The most relevant URs and recommendations are shown below in

Table 23. IACS URs

UR No.	Description	Revision
<b>M</b>	<b>Machinery Installations</b>	
M2	Alarm devices of internal combustion engines	Rev. 0 1971
M3	Speed governor and overspeed protective device	Rev.6 Nov 2018
M9	Crankcase explosion relief valves for internal combustion engines	Rev.3 Jan 2005 Corr.1 Nov 2005 Corr.2 Sep 2007
M10	Protection of internal combustion engines against crankcase explosions	Rev.4 July 2013
M11	Protective devices for starting air mains	Rev.0 1972
M12	Fire-extinguishing systems for scavenge manifolds	Rev.0 1972
M25	Astern power for main propulsion	Rev.4 June 2017
M27	Bilge-level alarms for unattended machinery spaces	Rev.0 1976
M28	Ambient reference conditions	Rev.0 1978
M29	Alarm systems for vessels with periodically unattended machinery spaces	Rev.3 1997
M30	Safety systems for vessels with periodically unattended machinery spaces	Rev.1 1997
M31	Continuity of electrical power supply for vessels with periodically unattended machinery spaces	Rev.0 1978
M35	Alarms, remote indications and safeguards for main reciprocating internal combustion engines installed in unattended machinery spaces	Rev.8 Jan 2019
M36	Alarms and safeguards for auxiliary reciprocating internal combustion engines driving generators in unattended machinery spaces	Rev.6 Dec 2018
M40	Ambient conditions – Temperatures	Rev.0 1981
M43	Bridge control of propulsion machinery for unattended machinery spaces	Rev.0 1982
M44	Documents for the approval of diesel engines	Rev.10 Feb 2021 Corr.1 Feb 2022
M45	Ventilation of machinery spaces	Rev.2 Feb 2011
M46	Ambient conditions - Inclinations	Rev.2 Dec 2018
M47	Bridge control of propulsion machinery for attended machinery spaces	Rev.0 1983
M51	Factory Acceptance Test and Shipboard Trials of internal combustion engines	Rev.4 Feb 2015 Corr.1 Oct 2018
M53	Calculations for Internal Combustion Engine crankshafts	Rev.4 Aug 2019
M57	Use of ammonia as a refrigerant	Rev.0 1993
M60	Control and Safety of Gas turbines for Marine Propulsion Use	Rev.1 Nov 2021
M61	Starting Arrangements of Internal Combustion Engines	Rev.1 Feb 2022
M63	Alarms and Safeguards for Emergency Diesel Engines	Rev.0 Jan 2005
M66	Type Testing Procedure for Crankcase Explosion Relief Valves	Rev.4 Feb 2021 Corr.1 Oct 2021
M67	Type Testing Procedure for Crankcase Oil Mist Detection and Alarm Equipment	Rev.2 Feb 2015
M71	Type Testing of Internal Combustion Engines	Rev.0 Feb 2015 Corr.1 June 2016
M72	Certification of Engine Components	Rev.2 Jan 2019
M73	Turbochargers	Rev.0 Feb 2015 Corr.1 June 2016
M75	Ventilation of emergency generator rooms	Rev.1 Jan 2021
M76	Location of fuel tanks in cargo area on oil and chemical tankers	Rev.1 June 2018
M77	Storage and use of SCR reductants	Rev.3 Sep 2021
M78	Safety of Internal Combustion Engines Supplied with Low Pressure Gas	Rev.1 Feb 2021
M80	Requirements for AC generating sets	Rev.0 May 2019

UR No.	Description	Revision
M81	Safety measures against chemical treatment fluids used for exhaust gas cleaning systems and the residues which have hazardous properties	Rev.0 Jan 2021
<b>E</b>	<b>Electrical and Electronic Installations</b>	
E5	Voltage and frequency variations	Rev.1 Sep 2015
E7	Cables	Rev.5 Feb 2021
E9	Earthing and bonding of cargo tanks/process plant/piping systems for the control of static electricity	Rev.1 Oct 2012
E10	Test Specification for Type Approval	Rev.8 Feb 2021 Corr.1 Jan 2022
E13	Test requirements for Rotating Machines	Rev.3 Dec 2020
E15	Electrical Services Required to be Operable Under Fire Conditions and Fire-Resistant Cables	Rev.4 Dec 2020
E19	Ambient Temperatures for Electrical Equipment installed in environmentally controlled spaces	Rev.1 Sep 2005
E20	Installation of electrical and electronic equipment in engine rooms protected by fixed water-based local application fire-fighting systems	Rev.1 June 2009
E22	Onboard Use and Application of Computer-based systems	Rev.2 June 2016
<b>F</b>	<b>Fire protection</b>	
F20	Inert Gas Systems	Rev.7 May 2015
F26	Safety aspects of double bottoms and duct keels under cargo oil tanks	Rev.3 May 2004
F29	Non-sparking fans	Rev.6 June 2005
F32	Fire-detecting systems for unattended machinery spaces	Rev.0 1976
F33	Prohibition of carriage in fore peak tanks of oil or other liquid substances which are flammable	Rev.0 1981
F35	Fire Protection of Machinery Spaces	Rev.8 June 2005
F42	Fire testing of flexible pipes	Rev.0 1995
F43	Installation requirements for analysing units for continuous monitoring of flammable vapours	Rev.2 June 2002
<b>G</b>	<b>Gas Tankers</b>	
G1	Vessels with cargo containment systems for liquefied gas	Rev.3 June 2016 Corr.1 May 2018 Corr.2 Oct 2021
G2	Liquefied gas cargo tanks and process pressure vessels	Rev.2 Dec 2018
G3	Liquefied gas cargo and process piping	Rev.7 Dec 2019
<b>P</b>	<b>Pipes and Pressure Vessels</b>	
P1	Rules for pipes	Rev.5 Nov 2001
P2	Rules for piping design, construction and testing	Rev.2 Nov 2001
<b>W</b>	<b>Materials and Welding</b>	
W1	Material and welding for ships carrying liquefied gases in bulk and ships using gases or other low-flashpoint fuels	Rev.4 Apr 2021
<b>Z</b>	<b>Survey and Certification</b>	
Z16	Periodical surveys of cargo installations on ships carrying liquefied gases in bulk	Rev.4 Oct 2013
Z18	Survey of Machinery	Rev.9 Apr 2020
Z25	Periodic Survey of Fuel Installations on Ships other than Liquefied Gas Carriers utilising gas or other low-flash point fuels	Rev.1 Sep 2017
Z26	Alternative Certification Scheme	Rev.0 Feb 2015

Table 24. IACS Recommendations

Rec No.	Description	Revision
26	List of minimum recommended spare parts for main internal combustion engines of ships for unrestricted service	Rev. 1 Nov 2006
27	List of minimum recommended spare parts for each type of auxiliary internal combustion engine driving electric generators for essential services onboard ships for unrestricted service	Rev.1 Nov 2006
30	List of minimum recommended spare parts for essential auxiliary machinery of ships for unrestricted service	Rev.1 Jan 2006
35	Inspection and Maintenance of Electrical Equipment Installed in Hazardous Areas for Ships other than Tankers	Rev.2 Feb 2021
41	Guidance for Auditors to the ISM Code	Rev.5 Oct 2019
57	Maintenance and inspection of electrical equipment on the ship	Rev.1 Mar 2016
58	Fire Protection of Machinery Spaces	Rev.2 Feb 2021
74	A guide to managing maintenance in accordance with the requirements of the ISM Code	Rev.2 Aug 2018
114	Recommendations for operational testing, inspection and documentation of emergency-shutdown valves for liquefied gas carriers	Rev.1 Dec 2018
123	Recommendation based on IMO instruments -MSC.1/Circ.1370 "Guidelines for the design, construction and testing of fixed hydrocarbon gas detection systems" and Resolution MSC.292 (87) "Amendments to the FSS Code Chapter 16 Fixed Hydrocarbon Gas Detection Systems"	Rev.0 May 2012
138	Recommendation for the FMEA process for diesel engine control systems	Rev.0 Dec 2104
142	LNG bunkering guidelines	Rev.0 June 2016
146	Risk assessment as required by the IGF Code	Rev.0 Aug 2016
147	Type Approval Certificate of Internal Combustion Engine	Rev.0 Oct 2016
148	Survey of liquefied gas fuel containment systems	Rev.1 Mar 2020
169	Guidelines on Approval of High Manganese Austenitic Steel for Cryogenic Service	Rev.0 Sep 2021

Most of these requirements are applicable to engines and machinery installations for all types of fuels, including those using gases or low-flashpoint fuels, without the need for revision or change of scope. However, there are some significant gaps that require new or revised publications to be developed by IACS. Experience from similar processes with LNG would dictate that additional updates to IACS' recommendations will be required to promote adoption. These new or revised IACS publications may require action:

- IACS UR M78. Safety of Internal Combustion Engines Supplied with Low Pressure Gas. This UR is currently under revision; as published, it only covers low-pressure trunk piston engines using gas (methane) as fuel. IACS UR M59, which covered high-pressure applications has been withdrawn, so the association's guidance has gaps for high-pressure and cross-head (2-stroke slow speed) engines burning methane. It also has gaps on equivalent requirements for all other low-flashpoint fuels. It may be possible to update UR M78 to cover all engine types and fuels in a more general way, but industry awaits IACS' efforts on this.
- Recommendation No. 142. LNG bunkering guidelines. Updating this document to cover bunkering of all liquefied gases would be a way to address the gap; alternatively, a new IACS publication should be encouraged.
- Recommendation No. 146. Risk assessment as required by the IGF Code. This publication needs revising to provide specific guidance for undertaking risk assessments for hydrogen.
- Recommendations 26, 27 and 30. Investigation is needed to determine whether recommendations for spare parts need to be updated to fully cover modern electronic engines, including DF components.
- Recommendation 138. Consider updating the engine FMEA (failure modes and effects analysis) recommendation to fully cover modern electronic engines including, DF components and systems.



Recognising the increased interest in hydrogen as a fuel, some class societies have recently published several rules, guides and supporting documents:

- Guides/Guidelines:
  - American Bureau of Shipping (ABS).
    - ABS Requirements for Hydrogen Fueled Vessels. Published May 2023. This is the first classification document to establish requirements for hydrogen fuelled vessels, associated with the low-flashpoint fuel notation. This guide is based on requirements derived from the IGF code with specific requirements for liquid or gaseous hydrogen fuel systems.
    - ABS Guide for Gas and Other Low-Flashpoint Fuel Ready Vessels. Published in March 2022.
    - ABS Guide for Fuel Cell Power Systems for Marine and Offshore Applications. Published in November 2019.
  - Lloyd's Register (LR)
    - Classification of Ships Using Gases or Other Low-Flashpoint Fuels
  - Bureau Veritas (BV). Ships Using Fuel Cells. Rule Note NR 547 R01. Published in Jan. 2022
  - Det Norske Veritas (DNV). Handbook for hydrogen-fuelled shipping. Published in June 2021.
  - Korean Register (KR). Guidelines for Selection of Metallic Materials of Containment Systems for Alternative Fuels for Ships. Published in June 2022.
  - NKK (Nippon Kaiji Kyokai – ClassNK). Guidelines for Liquefied Hydrogen Carriers. published in March 2017.
- Supporting Documents:
  - ABS Sustainability Whitepaper Hydrogen as Marine Fuel. Published in June 2021.
  - NKK (Nippon Kaiji Kyokai – ClassNK) Guidelines for Ships Using Alternative Fuels. Edition 2.0. Published in July 2021.
  - Bureau Veritas (BV) Gas-Fuelled Ships. Published in July 2022.

Hydrogen's properties have a significant impact on the development of rules for its use as a marine fuel. Risk-mitigation strategies may include robust design, early leak detection, water dousing and PPE. Effectively, the safety concepts introduced by MSC.420(97) are the starting point for guidelines and tentative rules, many of which also follow the structure and content of the IGF Code.

To further support its adoption as a marine fuel and understanding of the risks associated with its use, class societies offer advisory or consultancy services, including risk assessments, a review of statutory rules or international standards, workshops and recommendations for approving alternative designs.

Furthermore, many class societies have introduced 'ready' rules or guides. These were introduced to respond to demand for flexibility and capability in vessel designs that would support future conversions to alternative fuels such as LNG, hydrogen, methanol or ammonia.

The scope of such 'ready' preparations or modifications can differ significantly from ship to ship, so they need to be agreed between the shipowner and the shipbuilder on a case-by-case basis.

It is important to recognise that these 'ready' assessments only should be reviewed in association with the Rules or regulations in place at the time of construction; they also do not guarantee compliance with the Rules or regulations in place at the time of conversion.

There is a broad scope of application for these 'ready' assessments, ranging from high-level concepts with little detail and no installed systems or components, to more mature designs with some components or systems installed at new construction, or which are suitable for easier conversion at a later date; in some cases, they are designed to be suitable for switching to other fuels.

However, the wide variability of items such as fuel properties, energy density, storage conditions, material properties and density limit the options for transitioning from one (gaseous or liquefied gaseous fuel) to another without oversizing or over-specifying at the initial design stage; this is particularly so for high-cost items such as fuel containment systems and internal combustion engines. In many cases, it may not be cost effective to convert equipment later.

### 3.3 Regulations for EU Member States

On 14 July 2021, the European Commission presented ‘Fit-for-55’ (Figure 25 and Figure 26), a package of measures that seeks to align EU policies on climate, energy, land use, transport and taxation in such a way that the net GHG emissions can be reduced at least 55% by 2030, compared to 1990. It contains proposals for revising regulations and directives and some new policy initiatives.



Figure 25. The European Commission ‘Fit-for-55’ package

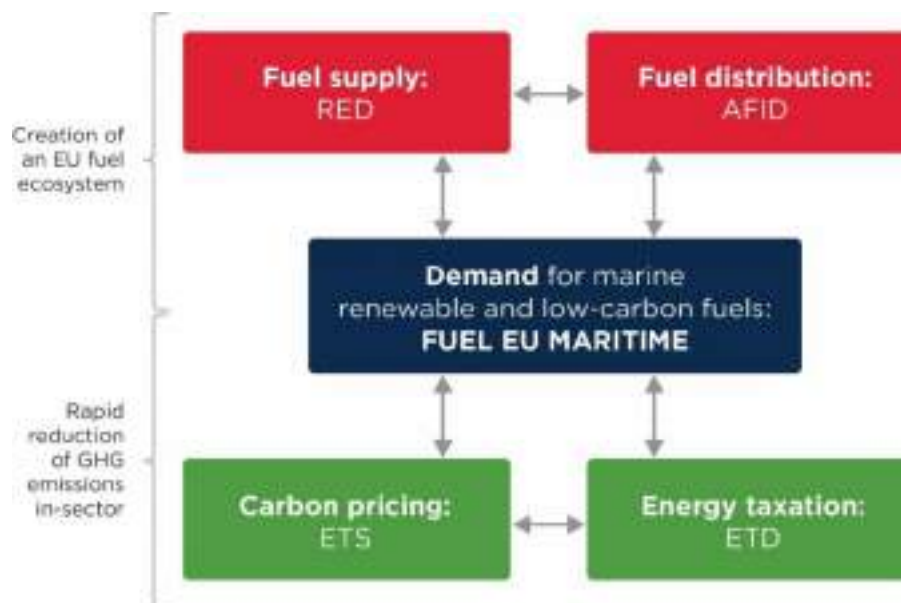

Figure 26. EU policies related to maritime transport

## **FuelEU Maritime**

As part of the 'Fit for 55' package, the EC launched the FuelEU Maritime Initiative to increase demand for renewable and low-carbon fuels (RLF) for ships sailing to and from EU ports. It also sought to reduce the emissions from navigation and at berth, and to support EU and international climate objectives.

FuelEU Maritime sets a harmonised regulatory framework in the EU and aims to increase the share of renewable and low-carbon fuels used in the fuel mix for international maritime transport, including: liquid biofuels, e-liquids, decarbonised gas (including bio-LNG and e-gas), decarbonised hydrogen and its derived fuels (including methanol and ammonia) and electricity.

The initiative will contribute to wider goals by pursuing specific objectives to:

1. Enhance predictability by setting a clear regulatory environment for the use of RLF in maritime transport
2. Stimulate technology development
3. Stimulate production on a larger scale of RLF with high technology readiness levels (TRLs) and reduce the price gap with current fuels and technologies
4. Create demand from ship operators to bunker RLF or connect to electric grid while at berth
5. Avoid carbon leakage

FuelEU maritime will require ships of 5,000 GT and above to gradually reduce the GHG intensity limits of energy used onboard against the 2020 benchmark average value by:

- 2% as of 2025
- 6% as of 2030
- 14,5% as of 2035
- 31% as of 2040
- 62% as of 2045
- 80% as of 2050

This will cover 100% of the energy used on intra-EU voyages and 50% of the energy on extra-EU voyages. It is also noted that in 2028 the Commission will review whether the 5,000 GT threshold should be lowered and if the requirements of the Regulation should be tightened.

Renewable hydrogen, which has a lower GHG intensity than fossil fuels on a well-to-wake basis, is likely to be used to comply with 'Fit for 55' requirements. It is worth noting that FuelEU Maritime incentivises the use of renewable fuels of non-biological origin (RFNBO), requiring member States to ensure that these are available in ports. The European Commission will monitor the availability of RFNBOs and if the uptake is less than 1%, then a 2% target will be set for 2034.

## **EU ETS**

Another important part of the 'Fit-for-55' package, the EC decided under Directive 2023/959 to extend to maritime transport the scope of the EU Emissions Trading System (EU ETS), which was established by the Directive 2003/87/EC of the European Parliament. This system has two principles: setting a ceiling on the yearly maximum amount of GHG emissions; and enabling the trading of EU emission allowances. These principles aim to contribute to the wider EU goal to eliminate at least 55% of the continent's net GHG emissions by 2030, compared to 1990.

From 2025, shipping companies will have to surrender sufficient EU emission allowances based on the EU monitoring, reporting and verification (MRV) data of the previous year. If the allowances prove insufficient, additional allowances can be acquired, or a reduction of the carbon emissions will be needed. For each tonne of CO<sub>2</sub> equivalent that has been emitted without surrendering allowances, shipping companies will have to pay a penalty of EUR 100.

To ensure a smooth transition of the shipping industry to the EU ETS scheme, companies will have to surrender allowances for 40% of the verified emissions in 2024 and 70% in 2025. From 2026 onwards, 100% of the verified emissions will be considered.

Since shipping companies will be paying for the CO<sub>2</sub> they emit, this system can stimulate lower output; it will be up to them to determine the method by which that is achieved. Although renewable fuels such as renewable hydrogen can reduce GHG emissions, the adoption of renewable fuels would not be directly stimulated by the shipping industry implementing EU ETS (EC, 2021).

## **RED II**

The second phase of the Renewable Energy Directive (RED II) is an EU instrument that aims to promote the use of energy from renewable sources. The RED II sets a target for all modes of transport to use at least 32% renewable energy by 2030. It includes a specific 'RES-T' target of at least 14% renewable energy in the final energy consumption (level of energy consumed after losses) from transport by 2030.

The renewable energies in transport could consist of biofuels, renewable fuels of non-biological origin (RFNBO, such as hydrogen and ammonia) and include recycled carbon fuels. At all times, the sustainability requirements should be met. With respect to renewable fuels in maritime shipping, the RED II allows member states to apply those fuels towards their RES-T target.

The RED II's impact assessment identified an additional challenge specific to the maritime sector: the juxtaposition of the shipowners' and operators' incentives does not work to stimulate the deployment of renewable fuels.

In response, and to introduce incentives for the maritime and aviation sectors, fuels supplied to either are measured at 1.2 times their energy content (except for fuels produced from food and feed crops) when demonstrating compliance with the renewable-energy target. This provision is meant to boost the uptake of renewable energy in these transport modes.

The 20% extra counting has implications for fuel volumes; as lower fuel volumes will be required to meet the target, the amount by which GHG emissions will be reduced may be adversely impacted.

### *Type of renewable fuels within the RED II*

The original RED required member states to oblige fuel suppliers within their jurisdiction to supply a minimum share of renewable energy to the transport sector and to design their supply policies accordingly.

Although the RED only plays a limited role in increasing the share of renewable fuels in shipping, it remains relevant to the maritime sector, given its mature sustainability framework; lessons learned in the past from using biofuels (both liquid and gaseous) in the road-transport sector can help to shape a sustainability framework for use in shipping.

For sustainability reasons, the growth in the RED should come from advanced biofuels and RFNBO. This includes focusing on generating hydrogen from renewable energy. A dedicated act, which was expected to be published by the end of 2021, should already have set out the requirements for the renewable electricity used to produce renewable hydrogen and its derived fuels.

### ***Revision of the REDII: the REDIII***

Because of the higher ambitions of the European Green Deal for reducing net GHG emissions by at least 55% by 2030, the RED II is already being revised before many member states have transposed it into national legislation. The 'Fit for 55' package contains a proposal for the revised directive, referred to as the [Renewable Energy Directive III](#).

To achieve the 2030 target, the proposal suggests increasing the overall binding target for renewables in the EU energy mix to 40% from the current 32%. This will be complemented by indicative national targets that show what each member state should contribute to secure the collective target.

The directive aims for large-scale renewables-based electrification. In transport and industry, with market segments that are harder to electrify, renewable fuels such as clean hydrogen also should play a major role.

The transport target, which aims for a specific share of renewables in final consumption, will be replaced by a GHG-intensity target: the GHG intensity of fuels (in gCO<sub>2</sub>/MJ) is to be reduced by at least 13% by 2030 compared to the baseline. This will replace the average reduction target for GHG intensity found in the Fuel Quality Directive.

In addition to the sub-target for the share of advanced biofuels and biogas (based on feedstocks from Part A of Annex IX), the RED also introduces a 2.6% sub-target for the share of RFNBOs by 2030, which is applicable to renewable hydrogen. The RED contained various multiplication factors that made some of the targets purely administrative. By abolishing these multiplication factors, the proposal for revision makes the targets more ambitious.

### **Energy Taxation Directive (ETD)**

Taxation initiatives at the EU and member-state level help industries to reach the climate-policy goals by encouraging a switch to cleaner energy. The EU's ETD entered into force in 2003, offering structural rules and minimum rates for excise duties to tax the energy products that are used as motor and heating fuels, and for electricity.

Individual member states are free to set their own rates provided the directive's minimum rates are respected.

Some sectors, such as aviation and maritime transport, until now have been fully exempt from energy taxation in the EU. However, a revision of the ETD was proposed in the EU's 'Fit-for-55' package; it introduces a new structure of tax rates based on the energy content and the environmental performance of fuels and electricity. This will help the system to ensure the most polluting fuels are taxed the highest.

The revision also broadens the taxable base by including more products into the scope and removing some of the current exemptions and reductions (EC, 2020).

## **3.4 Other National Regulations**

In this section, other relevant regulations from nations other than European are listed.

Individual sovereign governments have developed their own national regulations related to the production, transport, storage and application of hydrogen. An in-depth analysis of all global regulation is beyond the scope of this study. However, brief references and representative summary information is included in this subsection. Of particular interest to the application of hydrogen as a marine fuel are the considerations for flammability and gas dispersion.

### **3.4.1 United States**

#### **NFPA 2 Hydrogen Technologies Code. Edition 2.**

The National Fire Protection Association code was created to help establish fundamental safety measures for the production, installation, storage, piping, use and handling of hydrogen in compressed gas or cryogenic liquid forms. This code is applicable to all occupancies and locations for the production, storage, transfer and use of hydrogen. Applications for permanent, mobile and vehicular infrastructure are included in the utilisation of hydrogen.

Other NFPA Codes that may apply to hydrogen systems or applications using hydrogen include (Blake, Buttner, & Rivkin, 2010):

- NFPA 52 Vehicular Fuel Systems Code
- NFPA 55 Standards for Storage, Use and Handling of Compressed Gases and Cryogenic Fluids in Portable and Stationary Containers, Cylinders and Tanks

#### **NIST Handbook 130, The U.S. National Work Group (USNWG).**

To address gaseous hydrogen refuelling applications, the U.S. National Institute of Standards and Technology (NIST) National Work Group (USNWG) for the Development of Commercial Hydrogen Measurement Standards continues to advocate for the adoption of new fuel-quality requirements and associated definitions for the NIST Handbook 130 (HB 130) Standard Specifications for Hydrogen Fuel.

#### **U.S. 40 CFR Ch. I Subchapter J Part 370 Hazardous Chemical Release Reporting: Community Right-To-Know.**

This part of the United States' Environmental Protection Agency (EPA) Code of Federal Regulations (CFRs) specifies information relating to the release of hazardous chemicals which require material safety data sheets or safety data sheets, with the intention of informing the public and communities surrounding any covered facilities about releases of hazardous chemicals.

#### **U.S. 29 CFR Ch. XVII Part 1910 Subpart H: Occupational Safety and Health Standards: 103 Hydrogen.**

While this is a standard regarding the safe operation for the protection of health, it covers basic design, construction, location, installation and operation of gaseous and liquefied hydrogen systems. Gaseous hydrogen system containers and safety-relief devices are to be designed, constructed and tested in accordance with the ASME Boiler and Pressure Vessel Code (BPVC), Section VIII. Liquefied hydrogen containers must also meet the requirements in the ASME BPVC; safety-relief devices are to meet the CGA Pamphlet S-1. For gaseous and liquefied systems, reference is made to the ANSI B31.1-1967 Industrial Gas and Air Piping Code for Pressure Piping for piping and tubing systems.

#### **ASME B31.12-2019 Hydrogen Piping and Pipelines.**

This American Society of Mechanical Engineers (ASME) Code covers the requirements for pipes used in gaseous and liquid hydrogen service and pipelines in gaseous hydrogen service. It covers materials, welding, heat treating, forming, testing, inspection, examination, operations and maintenance, in general.

#### **ASME BPVC Section VIII Rules for Construction of Pressure Vessels. Division 1, Division 2-Alternative Rules and Division 3-Alternative Rules for Construction of High-Pressure Vessels.**

This code in general addresses the design, fabrication, inspection, testing and certification of pressure vessels, including those that may be used for gaseous hydrogen service.

#### **CGA S-1.1 Pressure Relief Device Standards – Part 1 – Cylinders for Compressed Gases & S-1.2 Pressure Relief Device Standards – Part 2 – Portable Containers for Compressed Gasses.**

The U.S. Compressed Gas Association (CGA) publishes standards for handling gases, including pressure-relief devices for gaseous hydrogen or liquefied hydrogen containers.

#### **CGA H-3: Standard for Cryogenic Hydrogen Storage.**

This standard includes the minimum design and performance requirements for vacuum-insulated cryogenic tanks for liquid hydrogen limited by the maximum allowable working pressure.

#### **CGA G-5.4 Standard for Hydrogen Piping Systems at User Locations.**

This standard is intended to provide general information for designers, fabricators, installers, users and maintenance of hydrogen piping systems, as well as for safety personnel, fire departments, building inspectors and emergency personnel. It covers recommended principles for gaseous (Type I) or liquid (Type II) hydrogen.

#### **CGA G-5.5 Hydrogen Vent Systems.**

This standard directs the design, installation and maintenance of vents for hydrogen systems in gaseous and liquefied service. This publication supports other CGA Standards for hydrogen safety, utilisation and operations.

### **3.4.2 Australia**

#### **Standards Australia, ME-093 Hydrogen Technologies Strategic Work Plan.**

A work plan for the business, technological, safety and environmental trends of the hydrogen industry has been developed by Standards Australia (AS). Based on ISO and IEC publications, the ME-093 Hydrogen Technologies committee determines the priority standards to be implemented. The plan's scope covers the use of hydrogen as an energy carrier along the entire value chain, including production, handling, storage, measurement, transport and distribution of either pure hydrogen or hydrogen mixed with other fuel gases. Applications for power and heat

generation, home and industrial appliances, transportation, infrastructure for hydrogen refuelling and other end uses are included.

#### **AS ISO 15916:2021 Basic considerations for the Safety of Hydrogen Systems.**

AS has adopted international standards and made modifications, such as this document, modifying the ISO 15916 standard with additional Appendix ZZ listing variations for use of the standard in Australia.

#### **AS 26142:2020 Hydrogen Detection Apparatus – Stationary Applications.**

AS adopts the ISO 26142:2010 with modifications included in Appendix ZZ for use of the standard in Australia.

### **3.4.3 United Kingdom**

The British Standards Institution (BSI) is recognised by the UK Government as the National Standards Body. It functions primarily to authorise and adopting international standards or European Directives into UK law, including the ISO, IEC, EC and other standards such as:

#### **Pressure Equipment Regulations (PER) 1999.**

These BSI Regulations implement the European Commission's (EC) Pressure Equipment Directive (97/23/EC), which covers the design, manufacture and testing of pressure vessels and equipment.

#### **Equipment and protective Systems for Use in Potentially Explosive Atmospheres (EPS) Regulations 1996.**

These BSI regulations implement the requirement of the Atmosphères Explosibles (Explosive Atmospheres, or ATEX) Equipment Directive 94/9/EC regarding the design and manufacture of equipment for use in potentially explosive environments at places of work.

#### **Dangerous Substances and Explosive Atmospheres Regulations (DSEAR) 2002.**

The BSI Regulations are similar to EPS but also cover the safety of workers and the workplace by offering minimum requirements for minimising the risks from explosive atmospheres, implemented in the requirement of the ATEX Workplace Directive 99/92/EC.

### **3.4.4 Japan**

In Japan, there are no specific laws for using hydrogen. However, it is regulated as a high-pressure gas and is regarded as such within the scope of existing Japanese regulations.

#### **Association of Hydrogen Supply and Utilization Technology (HySUT).**

The goals of HySUT include ensuring stable supply and safe distribution of hydrogen. The association acts as a member to the ISO Technical Committee 197 (ISO/TC197) on Hydrogen Technologies. Several Guidelines for hydrogen technology are available from HySUT, including guidelines for quality control, metering, filling performance, testing setups and hydrogen-powered industrial truck filling. The focus of HySUT is primarily on the implementation of road-based hydrogen technologies, but it could expand to include hydrogen fuelled marine vessels.

#### **High Pressure Gas Safety Act (Last version: Act No. 73 of 2005).**

In general, this act is in place to regulate the production, storage, transportation, consumption and marketing of high-pressure gases, including construction and the handling of high-pressure gas containers.

#### **Regulation for Enforcement of the Air Pollution Control Act (Last version: Act No. 45 of 2017).**

To protect the environment and monitor emissions, this act requires notification to local government of the emissions measurement from gas generators, including reformers for hydrogen production and fuel cells.

### 3.4.5 China

In China, hydrogen standards are managed by the Standardization Administration of the People's Republic of China (SAC). Technical committees (TCs) focus on developing national standards for hydrogen, including:

- National Technical Committee of Hydrogen Energy (SAC/TC 309)
- National Technical Committee of Fuel Cell and Flow Battery (SAC/TC 342)
- Subcommittee of Electric Vehicles of National Technical Committee of Road Vehicles (SAC/TC 114/SC 27)
- Subcommittee of High-Pressure Vehicle Fuel Tanks of National Technical Committee of Gas Cylinders (SAC/TC 31/SC 8)
- National Committees of Gases, Work Safety, Metallic and Non-Metallic Coatings (Yang, et al., 2019).

As of March 2022, SAC has approved the release of 101 national standards in the field of hydrogen energy, covering terminology, hydrogen safety, hydrogen production, hydrogen storage and transportation, hydrogen refueling stations, fuel cells and their applications.

National standards have been formulated under the categories for the activities listed below:

- Hydrogen Production:
  - Water electrolysis hydrogen production
  - Pressure-swing adsorption purification hydrogen production
  - Solar photocatalytic hydrogen production
- Hydrogen storage and transportation:
  - Fixed high-pressure hydrogen storage containers
  - National standards such as hydrogen storage devices for hydrogen refueling stations
- Hydrogen refuelling station technical specifications:
  - Hydrogen refueling stations
  - Refuelling connection devices
  - Mobile hydrogen refueling facilities
- Fuel cells:
  - Fuel cell systems and components
- Technical requirements and testing and evaluation methods for hydrogen energy applications
- Hydrogen energy applications
  - Standards for hydrogen fuel cell vehicles
  - Fuel cell backup power supplies
  - Portable fuel cell power generation systems
  - Stationary fuel cell power generation systems have been formulated.

#### **GB/T 40045-2021 Fuel specification for hydrogen-powered vehicles -- Liquid hydrogen (LH<sub>2</sub>)**

This document defines technical indications, test procedures and standards for fuel specification for hydrogen-powered vehicles - liquid hydrogen - packaging, marking, storage and transportation (for liquid hydrogen). This standard applies to liquid hydrogen that is kept in storage tanks, pipelines, or tank trucks and utilised as the fuel for proton exchange membrane fuel cell vehicles.

#### **GB/T40060-2021 Technical requirements for storage and transportation of liquid hydrogen**

This standard specifies the requirements for the installation of liquid hydrogen storage vessel during the storage and transportation of liquid hydrogen, the transportation of tank cars and liquid hydrogen tank containers, purging and replacement, safety and protection and accident handling. This standard is applicable to technical requirements for



the storage and transportation of liquid hydrogen vessels, liquid hydrogen transport vehicles and liquid hydrogen tank containers. This standard does not apply to the storage and transportation of liquid hydrogen in the military, national defence and aerospace fields.

### **GB/T40061-2021 Technical specification for liquid hydrogen production system**

This document outlines the fundamental technical requirements for the liquid hydrogen production system, including the equipment needed for hydrogen liquefaction, liquid hydrogen storage, hydrogen discharge, automatic control and detection analysis, electrical facilities, lightning protection, anti-static and protective grounding and auxiliary facilities. It also addresses safety protection. This standard is applicable to the design of liquid hydrogen production systems that are newly constructed, rebuilt, or enlarged. Systems for producing liquid hydrogen, which are employed in the aerospace, national defence and military industries, are exempt from this standard.

Under these technical committees, ISO, IEC and national standards are adopted regarding hydrogen.

## **3.5 Gap Analysis**

The regulatory framework for rules, standards, guidelines, recommendations and best practices, etc., for hydrogen is tabulated in detail as Appendix XIV – Detailed Regulatory Gap Analysis to this study. This highlights where the publications contribute to, or restrain, the adoption of hydrogen as a marine fuel.

As referenced throughout this section of the study, there are ‘gaps’ that will restrain adoption. Notably, these gaps are within the IMO’s safety and environmental regulations, together with the ISO standards that are referenced by the IMO mandatory requirements.

The precedent set by regulatory and industry publications for LNG provides a roadmap for filling some of the gaps that are anticipated; in many cases, this includes publications that are relatively easy to update to include a wider scope of liquefied gases.

The analysis is shown in Appendix XIV – Detailed Regulatory Gap Analysis and a synopsis of the findings is presented in Figure 25 and Figure 26.

Table 25. Gap Analysis Legend

No Gap or Changes needed to address hydrogen as marine fuel
Small Gap or Minor Change to address hydrogen as marine fuel
Medium Gap or Some Challenging Change to address hydrogen as marine fuel
Large Gap or Many Challenging Changes to address hydrogen as marine fuel

Table 26. Synopsis on Regulatory Gap Analysis for Hydrogen

Subject	Guidance/Code/Standard Title	Comment on Code/Standard – Gaps
Sustainability and Emissions Regulations	MARPOL Annex VI Regulation 14 - Sulphur Oxides (SOx) and Particulate Matter	- No significant gaps for supporting the application of hydrogen
	EU 'Fit-for-55' FuelEU Maritime	- Focus is only on decarbonised (green) hydrogen
	EU Emissions Trading System (ETS)	- Not directly applicable to shipping industry (until 2023 adoption of the 'Fit-for-55' package) - Only focused on tank-to-wake emissions, does not incorporate emissions from production
	MARPOL Annex VI Regulation 13 - Nitrogen Oxides, and NOx Technical Code (NTC)	- No significant gaps for supporting the application of hydrogen consumption in fuel cells. - Where hydrogen is consumed in internal combustion engines, systems are to meet NTC
	EU RED III	- Divided incentives for shipowners and operators do not stimulate the deployment of renewable fuels - Focus is only on decarbonised (green) hydrogen - Member states independently implement national policy
	EU Energy Taxation Directive (ETD)	- Maritime sector is fully exempt from directive - Member states independently implement national policy
	MARPOL Annex VI EEDI, EEXI, CII & DCS	- No explicit provision in IMO regulations and guidelines for the direct use of a hydrogen carbon factor in EEDI, EEXI, CII and DCS - Provision for well-to-wake emissions should be considered in these instruments
	Japan Regulation for Enforcement of the Air Pollution Control Act	- Not specific to marine hydrogen applications, but could be interpreted as also applying to marine emissions in Japan
Storage	ASME BPVC Section VIII Rules for Construction of Pressure Vessels, Division 1, Division 2-Alternative Rules & Division 3-Alternative Rules for Construction of High-Pressure Vessels	- Not specific to marine, may be referenced in marine standards
	CGA H-3 Standard for Cryogenic Hydrogen Storage	- Not specific to marine, may be referenced in marine standards
	CGA S-1 Pressure Relief Device Standards Part 1 & 2	- Not specific to marine, may be referenced in marine standards
	U.S. 40 CFR Ch. I Subchapter J Part 370 Hazardous Chemical Release Reporting: Community right-to-know	- No significant gaps for supporting the application of hydrogen
	UK BSI Pressure Equipment Regulations (PER) 1999	- Not specific to marine, may be referenced in marine standards or updated to include marine standards for pressure equipment in hydrogen use
	MSC.420(97)	- No significant gaps for supporting the application of hydrogen fuel

Subject	Guidance/Code/Standard Title	Comment on Code/Standard – Gaps
	ISO 13985:2006 Liquid Hydrogen - Land vehicle fuel tanks	- Not specific to marine fuel tanks, but may be referenced in marine standards or updated to include specifications for maritime use
	ISO 19881:2018 Gaseous Hydrogen - Land vehicle fuel containers	- Not specific to marine fuel tanks, but may be referenced in marine standards or updated to include specifications for maritime use
	ISO 19882:2018 Gaseous Hydrogen - Thermally activated pressure relief devices for compressed hydrogen vehicle fuel containers	- Not specific to marine fuel tanks, but may be referenced in marine standards or updated to include specifications for maritime use
	ISO 16111 Transportable gas storage devices - Hydrogen absorbed in reversible metal hydride	- Does not discuss system used for hydrogen fuel -May be referenced in fuel standards or updated to include provisions for use as fuel storage and containment
	IMO IGF Code	- IGF Code Part A-1 and IGC Code prescriptive provisions are specifically for natural gas (methane). Alternative Design process enables approval of other gases and low-flashpoint fuels or cargoes, but could be revised to include specific provisions for hydrogen in the longer term.
	IMO IGC Code	
Quality	ISO 14687:2019 Hydrogen Fuel Quality - Product Specification	- Not specific to marine service, but may be referenced in marine standards or updated to include specific requirements for marine service
	SAE J2719 Hydrogen Fuel Quality for Fuel Cell Vehicles	- Not specific to marine systems but may be referenced in marine standards
	SAE J3219_202206 Hydrogen Fuel Quality Screening Test of Chemicals for Fuel Cell Vehicles	- This and other standards from the SAE Fuel Cell Standards Committee are applicable to road vehicles, but may provide best practices and guidance to marine systems
	CIMAC WG17 Guideline on Hydrogen in Stationary 4-Stroke Gas Engines for Power Generation	- Not specific to marine fuels or engines in marine service, but may be referenced in marine standards or updated to include other types of engines or power generation service
	International Bunker Industry Association	- No specific guidance for hydrogen
	ISO 8217:2017 Petroleum Products - Fuels (class F) - Specifications of Marine Fuels	- Not applicable to and does not discuss hydrogen as marine fuel - Additional provisions for hydrogen specification (including hydrogen blends) for marine fuel may be developed as a new standard
	MARPOL Annex VI Regulation 18 - Fuel Oil Availability and Quality	- Regulation 18 for fuel oil availability and quality requires onboard fuel to be tested for sulphur content and to seal fuel samples for the record. While regulation 18.4 exempts gas fuels from BDN and fuel-sample requirements, regulation 18 would benefit from explicit clarification on BDN and fuel-sampling obligations for hydrogen or hydrogen blends with LNG as fuel
Transportation & Handling	MSC.1/Circ. 1599, 2019 Interim Guidelines on the Application of High Manganese Austenitic Steel for Cryogenic Services	- No significant gaps for supporting the application of liquefied (cryogenic) hydrogen
	MSC.1/Circ. 1622, 2020 Guidelines for the Acceptance of Alternative Metallic Materials for Cryogenic Service in Ships Carrying Liquefied Gasses in Bulk and Ships Using Gases or Other Low-Flashpoint Fuels	

Subject	Guidance/Code/Standard Title	Comment on Code/Standard – Gaps
	CGA 5.4 Standard for Hydrogen Piping Systems at User Locations	- Not specific to marine, may be referenced in marine standards
	CGA G-5.5 Hydrogen Vent Systems	
	UK BPI EPS Regulations 1996	- Not specific to marine, may be referenced in marine standards or updated to include specific considerations for marine hydrogen systems
	UK BPI DSEAR 2002	
	GB/T 40060-2021 Technical requirements for storage and transportation of liquid hydrogen	- Not specific to marine systems but may be referenced in marine standards
	U.S. 29 CFR Ch. XVII Part 1910 Subpart H: Occupational Safety and Health Standards: 103 Hydrogen	- No significant gaps for supporting the application of hydrogen
	ASME B31.12-2019 Hydrogen Piping and Pipelines	- Not specific to marine, may be referenced in marine standards
	ISO/TR 15916:2015 - Basic considerations for the safety of hydrogen systems	- Safety requirements for hydrogen handling operations not covered
	AS ISO 15916:2021 Basic considerations for the Safety of Hydrogen Systems	- May be referenced in marine standards or updated to include specific considerations for marine hydrogen systems
	NFPA 2 Hydrogen Technologies Code, Edition 2	- May be applicable to marine systems or referenced within marine standards. - May be updated to include provisions for hydrogen systems for marine use.
	NFPA 55 Standards for Storage, Use and Handling of Compressed Gases and Cryogenic Fluids in Portable and Stationary Containers, Cylinders and Tanks	
	SIGTTO Liquefied Petroleum Gas Sampling Procedures	- Not applicable to hydrogen. SIGTTO could produce similar recommendations for hydrogen gas cargo or fuel
	Japan Association of Hydrogen Supply and Utilization Technology (HySUT) Guidelines	- Not specific to or considers marine applications
	Japan High Pressure Gas Safety Act	- Not specific to marine
Bunkering	ISO 20159:2021 - Ships and Marine Technology - Specification for bunkering of liquefied natural gas fuelled vessels	- Not applicable to hydrogen or gaseous systems. Could be modified or used to develop liquefied hydrogen bunkering guidelines
	ISO/TS 18683:2021 - Guidelines for safety and risk assessment of LNG fuel bunkering operations	
	ISO 21593:2019 - Ships and Marine Technology - Technical requirements for dry-disconnect/connect couplings for bunkering liquefied natural gas	
	ISO 13984:1999 Liquid Hydrogen - Land vehicle fuelling system interface	- Not specific to marine bunkering systems, but may be referenced in marine standards or updated to include marine bunkering of liquid hydrogen
	ISO 17268:2020 Gaseous hydrogen land vehicle refuelling connection devices	- Not applicable to liquid hydrogen - Not specific to marine bunkering systems, but may be referenced in marine standards or updated to include marine bunkering of gaseous hydrogen
	ISO 19880 Gaseous Hydrogen - Fuelling Stations	
	SAE J2601/2_201409 Fuelling Protocol for Gaseous Hydrogen Powered Heavy-Duty Vehicles	- Not applicable to liquefied hydrogen - Not specific to marine bunkering systems, but may be referenced in marine standards
IACS Recommendation No. 142 LNG Bunkering Guidelines	- Could be updated to cover bunkering guidelines for all liquefied gases or new publication could be developed	
SIGTTO Ship/Shore Interface for LPG/Chemical Gas Carriers and Terminals		

Subject	Guidance/Code/Standard Title	Comment on Code/Standard – Gaps
	SIGTTO Recommendations for Liquefied Gas Carrier Manifolds	- SIGTTO publications address liquefied gases including hydrogen, but could provide specific guidance for hydrogen gas cargo or fuel
	SIGTTO Liquefied Gas Handling Principles on Ships and Terminals (LGHP4)	
	SIGTTO, CDI, ICS, OCIMF: Ship-to-Ship Transfer Guide for Petroleum, Chemicals and Liquefied Gases	- Could be modified or used to develop recommendations for hydrogen bunkering
	SGMF Bunkering Area Safety information LNG (BASiL)	- Not applicable to hydrogen. SGMF could expand these tools and guidelines, or develop new, to cover hydrogen as fuel
	SGMF FP02-01 Ver1.0 Gas as a marine fuel: Recommendation of Controlled Zones during LNG bunkering; May 2018	
	SGMF FP07-01 Ver3.0 LNG as a marine fuel: Safety and Operational Guidelines - Bunkering; December 2021	
	SGMF FP-08-01 Ver1.0 Gas as a marine fuel: Simultaneous Operations (SIMOPs) during LNG bunkering; May 2018	
	SGMF FP05-01 Ver1.0 Gas as a marine fuel: Contractual guidelines; September 2015	
	SGMF TGN06-04 Ver1.0 Gas as a marine fuel: manifold arrangements for gas-fuelled vessels; May 2019	
	SGMF TGN06-06 Ver1.0 Gas as a marine fuel: LNG bunkering with hose bunker systems: considerations and recommendations; February 2020	
	SGMF TGN06-07 Ver1.0 Gas as a marine fuel: Bunker station location: Considerations and Recommendations: January 2021	
	EMSA <i>Guidance on LNG Bunkering to Port Authorities and Administrations</i> ; January 2018	
Generation, Use & Consumption	MSC.1/Circ. 1647 <i>Interim guidelines for the safety of ships using fuel cell power installations</i>	- No significant gaps for supporting the application of hydrogen
	GB/T 40045-2021 Fuel Specifications for hydrogen-powered vehicles - Liquid Hydrogen (LH <sub>2</sub> )	- Not specific to marine systems but may be referenced in marine standards
	GB/T 40061-2021 Technical specification for liquid hydrogen production system	
	ISO 16110 Hydrogen generators using fuel processing technologies	No significant gaps for supporting the application of marine fuel cells, however, may not be applicable for hydrogen-fuel systems that do not need reforming for use in fuel cells.
	IMO draft <i>Interim Guidelines for the Safety of Ships using Fuel Cell Power Installations</i>	No significant gaps for supporting the application of marine fuel cells, however these guidelines do not cover fuel storage and distribution and therefore application is limited by lack of those IMO requirements
	IMO IGF Code	- IGF Code Part A-1 prescriptive provisions are specifically for natural gas (methane). Alternative Design process enables approval of other gases and low-flashpoint fuels but could be revised to include specific provisions for hydrogen in the longer term.
	SAE 2579_201906 Standard for Fuel Systems in Fuel Cell and Other Hydrogen Vehicles	- Not specific to marine systems but may be referenced in marine standards - This and other standards from the SAE Fuel Cell Standards Committee are applicable to road vehicles, but may provide best practices and guidance to marine systems

Subject	Guidance/Code/Standard Title	Comment on Code/Standard – Gaps
	ISO 22734:2019 Hydrogen generators using water electrolysis - Industrial, commercial and residential applications	- Not specific to marine, may be referenced in marine standards or updated to include specific considerations for marine hydrogen systems
	ISO 19882:2018 Gaseous Hydrogen - Thermally activated pressure-relief devices for compressed hydrogen vehicle fuel containers	- Not specific to marine fuel tanks, but may be referenced in marine standards or updated to include specifications for maritime use
	ISO 19883:2017 Safety of pressure swing adsorption systems for hydrogen separation and purification	- Not specific to non-stationary applications, may be referenced in marine standards or updated to include specifications for maritime use
	ISO 26142:2010 Hydrogen detection apparatus - Stationary applications	- Not specific to non-stationary applications, may be referenced in marine standards or updated to include specifications for maritime use
	AS 26142:2020 Hydrogen Detection Apparatus - Stationary Applications	
	SIGTTO ESD Systems - Recommendations for Emergency Shutdown and Related Safety Systems	- SIGTTO publications cover gas carriers and carriage of hydrogen but could benefit from specific consideration for hydrogen gas cargo or fuel
	SIGTTO Recommendations for Relief Valves on Gas Carriers	
	SIGTTO Guidelines for the Alleviation of Excessive Surge Pressures on ESD for Liquefied Gas Transfer Systems	
	IACS Recommendation Nos.26, 27 and 30; recommended spare parts for internal combustion engine (main and auxiliary) and essential auxiliary machinery	- Could be updated to cover spare parts for DF hydrogen engines and fuel supply systems
	IACS Recommendation No.138 Recommendation for the FMEA process for diesel engine control systems	
	IACS <i>Ammonia bunkering guidelines</i>	- Could be updated to cover bunkering guidelines for all liquefied gases or new publication could be developed
	IACS Classification Societies Rules	Harmonisation of Class Society rules or guidelines, through the development of Unified Requirements, would facilitate harmonised application of hydrogen as fuel
	<i>American Bureau of Shipping Requirements for Hydrogen Fueled Vessels</i>	- No significant gaps for supporting the application of hydrogen as marine fuel.
	SGMF FP00-01-06 Ver4.0 LNG as a marine fuel: An Introductory Guide; June 2021	- Not applicable to hydrogen (focus is on LNG). SGMF could expand or develop new publications for hydrogen as fuel
	SGMF FP10-01 Ver1.0 Gas as a marine fuel: Work practices for maintenance, repair and dry-dock operations; May 2020	
	SGMF FP14-01 Ver1.0 Gas as a marine fuel: Operations of ships with Liquefied Natural Gas (LNG) competency and assessment guidelines; May 2021	
	SGMF TGN06-05 Ver1.0 Gas as a marine fuel: recommendations for linked emergency shutdown (ESD) arrangements for LNG bunkering; May 2019	
	IMO STCW Convention	- Regulation for training of crew for IGF Code ships exists under STCW Convention. Questions remain on the application of hydrogen under IGF Code, but development of training courses and certification by flag Administrations is still required to enable crew certification for hydrogen as fuel under STCW.

Subject	Guidance/Code/Standard Title	Comment on Code/Standard – Gaps
	IACS UR M78 <i>Safety of Internal Combustion Engines Supplied with Low Pressure Gas</i>	<ul style="list-style-type: none"> <li>- Does not cover high-pressure and cross-head (2-stroke slow speed) engines burning gas.</li> <li>- Does not cover other low-flashpoint fuels.</li> <li>- Could be updated to include all engine types and fuels in more general way</li> </ul>
	IACS Recommendation No.146 <i>Risk assessment as required by the IGF Code.</i>	<ul style="list-style-type: none"> <li>- Could be updated to include specific requirements for hydrogen</li> </ul>
	ISM Code	Development of operational requirements under IGF Code, or Interim Guidelines, would facilitate operators undertaking obligations under ISM Code
Sustainability and Emissions Regulations	MARPOL Annex VI Regulation 14 - Sulphur Oxides (SOx) and Particulate Matter	<ul style="list-style-type: none"> <li>- No significant gaps for supporting the application of hydrogen</li> </ul>
	EU 'Fit-for-55' FuelEU Maritime	<ul style="list-style-type: none"> <li>- Focus is only on decarbonised (green) hydrogen</li> </ul>
	EU Emissions Trading System (ETS)	<ul style="list-style-type: none"> <li>- Not directly applicable to shipping industry (until 2023 adoption of the 'Fit-for-55' package)</li> <li>- Only focused on tank-to-wake emissions, does not incorporate emissions from production</li> </ul>
	MARPOL Annex VI Regulation 13 - Nitrogen Oxides, and NOx Technical Code (NTC)	<ul style="list-style-type: none"> <li>- No significant gaps for supporting the application of hydrogen consumption in fuel cells.</li> <li>- Where hydrogen is consumed in internal combustion engines, systems are to meet NTC</li> </ul>
	EU RED III	<ul style="list-style-type: none"> <li>- Divided incentives for shipowners and operators do not stimulate the deployment of renewable fuels</li> <li>- Focus is only on decarbonised (green) hydrogen</li> <li>- Member states independently implement national policy</li> </ul>
	EU Energy Taxation Directive (ETD)	<ul style="list-style-type: none"> <li>- Maritime sector is fully exempt from directive</li> <li>- Member states independently implement national policy</li> </ul>
	MARPOL Annex VI EEDI, EEXI, CII & DCS	<ul style="list-style-type: none"> <li>- No explicit provision in IMO regulations and guidelines for the direct use of a hydrogen carbon factor in EEDI, EEXI, CII and DCS</li> <li>- Provision for well-to-wake emissions should be considered in these instruments</li> </ul>
	Japan Regulation for Enforcement of the Air Pollution Control Act	<ul style="list-style-type: none"> <li>- Not specific to marine hydrogen applications, but could be interpreted as also applying to marine emissions in Japan</li> </ul>
Storage	ASME BPVC Section VIII Rules for Construction of Pressure Vessels, Division 1, Division 2-Alternative Rules & Division 3-Alternative Rules for Construction of High-Pressure Vessels	<ul style="list-style-type: none"> <li>- Not specific to marine, may be referenced in marine standards</li> </ul>
	CGA H-3 Standard for Cryogenic Hydrogen Storage	<ul style="list-style-type: none"> <li>- Not specific to marine, may be referenced in marine standards</li> </ul>
	CGA S-1 Pressure Relief Device Standards Part 1 & 2	<ul style="list-style-type: none"> <li>- Not specific to marine, may be referenced in marine standards</li> </ul>

Subject	Guidance/Code/Standard Title	Comment on Code/Standard – Gaps
	U.S. 40 CFR Ch. I Subchapter J Part 370 Hazardous Chemical Release Reporting: Community right-to-know	- No significant gaps for supporting the application of hydrogen
	UK BSI Pressure Equipment Regulations (PER) 1999	- Not specific to marine, may be referenced in marine standards or updated to include marine standards for pressure equipment in hydrogen use
	MSC.420(97)	- No significant gaps for supporting the application of hydrogen fuel
	ISO 13985:2006 Liquid Hydrogen - Land vehicle fuel tanks	- Not specific to marine fuel tanks, but may be referenced in marine standards or updated to include specifications for maritime use
	ISO 19881:2018 Gaseous Hydrogen - Land vehicle fuel containers	- Not specific to marine fuel tanks, but may be referenced in marine standards or updated to include specifications for maritime use
	ISO 19882:2018 Gaseous Hydrogen - Thermally activated pressure relief devices for compressed hydrogen vehicle fuel containers	- Not specific to marine fuel tanks, but may be referenced in marine standards or updated to include specifications for maritime use
	ISO 16111 Transportable gas storage devices - Hydrogen absorbed in reversible metal hydride	- Does not discuss system used for hydrogen fuel -May be referenced in fuel standards or updated to include provisions for use as fuel storage and containment
	IMO IGF Code	- IGF Code Part A-1 and IGC Code prescriptive provisions are specifically for natural gas (methane). Alternative Design process enables approval of other gases and low-flashpoint fuels or cargoes, but could be revised to include specific provisions for hydrogen in the longer term.
IMO IGC Code		
Quality	ISO 14687:2019 Hydrogen Fuel Quality - Product Specification	- Not specific to marine service, but may be referenced in marine standards or updated to include specific requirements for marine service
	SAE J2719 Hydrogen Fuel Quality for Fuel Cell Vehicles	- Not specific to marine systems but may be referenced in marine standards
	SAE J3219_202206 Hydrogen Fuel Quality Screening Test of Chemicals for Fuel Cell Vehicles	- This and other standards from the SAE Fuel Cell Standards Committee are applicable to road vehicles, but may provide best practices and guidance to marine systems
	CIMAC WG17 Guideline on Hydrogen in Stationary 4-Stroke Gas Engines for Power Generation	- Not specific to marine fuels or engines in marine service, but may be referenced in marine standards or updated to include other types of engines or power generation service
	International Bunker Industry Association	- No specific guidance for hydrogen
	ISO 8217:2017 Petroleum Products - Fuels (class F) - Specifications of Marine Fuels	- Not applicable to and does not discuss hydrogen as marine fuel - Additional provisions for hydrogen specification (including hydrogen blends) for marine fuel may be developed as a new standard
	MARPOL Annex VI Regulation 18 - Fuel Oil Availability and Quality	- Regulation 18 for fuel oil availability and quality requires onboard fuel to be tested for sulphur content and to seal fuel samples for the record. While regulation 18.4 exempts gas fuels from BDN and fuel-sample requirements, regulation 18 would benefit from explicit clarification on BDN and fuel-sampling obligations for hydrogen or hydrogen blends with LNG as fuel



Subject	Guidance/Code/Standard Title	Comment on Code/Standard – Gaps
Transportation & Handling	MSC.1/Circ. 1599, 2019 Interim Guidelines on the Application of High Manganese Austenitic Steel for Cryogenic Services	- No significant gaps for supporting the application of liquefied (cryogenic) hydrogen
	MSC.1/Circ. 1622, 2020 Guidelines for the Acceptance of Alternative Metallic Materials for Cryogenic Service in Ships Carrying Liquefied Gases in Bulk and Ships Using Gases or Other Low-Flashpoint Fuels	
	CGA 5.4 Standard for Hydrogen Piping Systems at User Locations	- Not specific to marine, may be referenced in marine standards
	CGA G-5.5 Hydrogen Vent Systems	
	UK BPI EPS Regulations 1996	- Not specific to marine, may be referenced in marine standards or updated to include specific considerations for marine hydrogen systems
	UK BPI DSEAR 2002	
	GB/T 40060-2021 Technical requirements for storage and transportation of liquid hydrogen	- Not specific to marine systems but may be referenced in marine standards
	U.S. 29 CFR Ch. XVII Part 1910 Subpart H: Occupational Safety and Health Standards: 103 Hydrogen	- No significant gaps for supporting the application of hydrogen
	ASME B31.12-2019 Hydrogen Piping and Pipelines	- Not specific to marine, may be referenced in marine standards
	ISO/TR 15916:2015 - Basic considerations for the safety of hydrogen systems	- Safety requirements for hydrogen handling operations not covered
	AS ISO 15916:2021 Basic considerations for the Safety of Hydrogen Systems	- May be referenced in marine standards or updated to include specific considerations for marine hydrogen systems
	NFPA 2 Hydrogen Technologies Code, Edition 2	- May be applicable to marine systems or referenced within marine standards. - May be updated to include provisions for hydrogen systems for marine use.
	NFPA 55 Standards for Storage, Use and Handling of Compressed Gases and Cryogenic Fluids in Portable and Stationary Containers, Cylinders and Tanks	
	SIGTTO Liquefied Petroleum Gas Sampling Procedures	- Not applicable to hydrogen. SIGTTO could produce similar recommendations for hydrogen gas cargo or fuel
	Japan Association of Hydrogen Supply and Utilization Technology (HySUT) Guidelines	- Not specific to or considers marine applications
Japan High Pressure Gas Safety Act	- Not specific to marine	
Bunkering	ISO 20159:2021 - Ships and Marine Technology - Specification for bunkering of liquefied natural gas fuelled vessels	- Not applicable to hydrogen or gaseous systems. Could be modified or used to develop liquefied hydrogen bunkering guidelines
	ISO/TS 18683:2021 - Guidelines for safety and risk assessment of LNG fuel bunkering operations	
	ISO 21593:2019 - Ships and Marine Technology - Technical requirements for dry-disconnect/connect couplings for bunkering liquefied natural gas	
	ISO 13984:1999 Liquid Hydrogen - Land vehicle fuelling system interface	- Not specific to marine bunkering systems, but may be referenced in marine standards or updated to include marine bunkering of liquid hydrogen
	ISO 17268:2020 Gaseous hydrogen land vehicle refuelling connection devices	- Not applicable to liquid hydrogen - Not specific to marine bunkering systems, but may be referenced in marine standards or updated to include marine bunkering of gaseous hydrogen
	ISO 19880 Gaseous Hydrogen - Fuelling Stations	

Subject	Guidance/Code/Standard Title	Comment on Code/Standard – Gaps
	SAE J2601/2_201409 Fuelling Protocol for Gaseous Hydrogen Powered Heavy-Duty Vehicles	<ul style="list-style-type: none"> <li>- Not applicable to liquefied hydrogen</li> <li>- Not specific to marine bunkering systems, but may be referenced in marine standards</li> </ul>
	IACS Recommendation No. 142 LNG Bunkering Guidelines	<ul style="list-style-type: none"> <li>- Could be updated to cover bunkering guidelines for all liquefied gases or new publication could be developed</li> </ul>
	SIGTTO Ship/Shore Interface for LPG/Chemical Gas Carriers and Terminals	<ul style="list-style-type: none"> <li>- SIGTTO publications address liquefied gases including hydrogen, but could provide specific guidance for hydrogen gas cargo or fuel</li> </ul>
	SIGTTO Recommendations for Liquefied Gas Carrier Manifolds	
	SIGTTO Liquefied Gas Handling Principles on Ships and Terminals (LGHP4)	
	SIGTTO, CDI, ICS, OCIMF: Ship-to-Ship Transfer Guide for Petroleum, Chemicals and Liquefied Gases	<ul style="list-style-type: none"> <li>- Could be modified or used to develop recommendations for hydrogen bunkering</li> </ul>
	SGMF Bunkering Area Safety information LNG (BASiL)	<ul style="list-style-type: none"> <li>- Not applicable to hydrogen. SGMF could expand these tools and guidelines, or develop new, to cover hydrogen as fuel</li> </ul>
	SGMF FP02-01 Ver1.0 Gas as a marine fuel: Recommendation of Controlled Zones during LNG bunkering; May 2018	
	SGMF FP07-01 Ver3.0 LNG as a marine fuel: Safety and Operational Guidelines - Bunkering; December 2021	
	SGMF FP-08-01 Ver1.0 Gas as a marine fuel: Simultaneous Operations (SIMOPs) during LNG bunkering; May 2018	
	SGMF FP05-01 Ver1.0 Gas as a marine fuel: Contractual guidelines; September 2015	
	SGMF TGN06-04 Ver1.0 Gas as a marine fuel: manifold arrangements for gas-fuelled vessels; May 2019	
	SGMF TGN06-06 Ver1.0 Gas as a marine fuel: LNG bunkering with hose bunker systems: considerations and recommendations; February 2020	
	SGMF TGN06-07 Ver1.0 Gas as a marine fuel: Bunker station location: Considerations and Recommendations: January 2021	
EMSA <i>Guidance on LNG Bunkering to Port Authorities and Administrations</i> ; January 2018	<ul style="list-style-type: none"> <li>- Not applicable to hydrogen. EMSA could expand or use this tool to develop hydrogen guidance</li> </ul>	
Generation, Use & Consumption	MSC.1/Circ. 1647 <i>Interim guidelines for the safety of ships using fuel cell power installations</i>	<ul style="list-style-type: none"> <li>- No significant gaps for supporting the application of hydrogen</li> </ul>
	GB/T 40045-2021 Fuel Specifications for hydrogen-powered vehicles - Liquid Hydrogen (LH <sub>2</sub> )	<ul style="list-style-type: none"> <li>- Not specific to marine systems but may be referenced in marine standards</li> </ul>
	GB/T 40061-2021 Technical specification for liquid hydrogen production system	
	ISO 16110 Hydrogen generators using fuel processing technologies	<ul style="list-style-type: none"> <li>No significant gaps for supporting the application of marine fuel cells, however, may not be applicable for hydrogen-fuel systems that do not need reforming for use in fuel cells.</li> </ul>
	IMO draft <i>Interim Guidelines for the Safety of Ships using Fuel Cell Power Installations</i>	<ul style="list-style-type: none"> <li>No significant gaps for supporting the application of marine fuel cells, however these guidelines do not cover fuel storage and distribution and therefore application is limited by lack of those IMO requirements</li> </ul>
IMO IGF Code	<ul style="list-style-type: none"> <li>- IGF Code Part A-1 prescriptive provisions are specifically for natural gas (methane). Alternative Design process enables approval of other gases and</li> </ul>	

Subject	Guidance/Code/Standard Title	Comment on Code/Standard – Gaps
		low-flashpoint fuels but could be revised to include specific provisions for hydrogen in the longer term.
	SAE 2579_201906 Standard for Fuel Systems in Fuel Cell and Other Hydrogen Vehicles	<ul style="list-style-type: none"> <li>- Not specific to marine systems but may be referenced in marine standards</li> <li>- This and other standards from the SAE Fuel Cell Standards Committee are applicable to road vehicles, but may provide best practices and guidance to marine systems</li> </ul>
	ISO 22734:2019 Hydrogen generators using water electrolysis - Industrial, commercial and residential applications	- Not specific to marine, may be referenced in marine standards or updated to include specific considerations for marine hydrogen systems
	ISO 19882:2018 Gaseous Hydrogen - Thermally activated pressure-relief devices for compressed hydrogen vehicle fuel containers	- Not specific to marine fuel tanks, but may be referenced in marine standards or updated to include specifications for maritime use
	ISO 19883:2017 Safety of pressure swing adsorption systems for hydrogen separation and purification	- Not specific to non-stationary applications, may be referenced in marine standards or updated to include specifications for maritime use
	ISO 26142:2010 Hydrogen detection apparatus - Stationary applications	- Not specific to non-stationary applications, may be referenced in marine standards or updated to include specifications for maritime use
	AS 26142:2020 Hydrogen Detection Apparatus - Stationary Applications	
	SIGTTO ESD Systems - Recommendations for Emergency Shutdown and Related Safety Systems	- SIGTTO publications cover gas carriers and carriage of hydrogen but could benefit from specific consideration for hydrogen gas cargo or fuel
	SIGTTO Recommendations for Relief Valves on Gas Carriers	
	SIGTTO Guidelines for the Alleviation of Excessive Surge Pressures on ESD for Liquefied Gas Transfer Systems	
	IACS Recommendation Nos.26, 27 and 30; recommended spare parts for internal combustion engine (main and auxiliary) and essential auxiliary machinery	- Could be updated to cover spare parts for DF hydrogen engines and fuel supply systems
	IACS Recommendation No.138 Recommendation for the FMEA process for diesel engine control systems	
	IACS <i>Ammonia bunkering guidelines</i>	- Could be updated to cover bunkering guidelines for all liquefied gases or new publication could be developed
	IACS Classification Societies Rules	Harmonisation of Class Society rules or guidelines, through the development of Unified Requirements, would facilitate harmonised application of hydrogen as fuel
	American Bureau of Shipping <i>Requirements for Hydrogen Fueled Vessels</i>	- No significant gaps for supporting the application of hydrogen as marine fuel.
	SGMF FP00-01-06 Ver4.0 LNG as a marine fuel: An Introductory Guide; June 2021	- Not applicable to hydrogen (focus is on LNG). SGMF could expand or develop new publications for hydrogen as fuel
	SGMF FP10-01 Ver1.0 Gas as a marine fuel: Work practices for maintenance, repair and dry-dock operations; May 2020	
	SGMF FP14-01 Ver1.0 Gas as a marine fuel: Operations of ships with Liquefied Natural Gas (LNG) competency and assessment guidelines; May 2021	

Subject	Guidance/Code/Standard Title	Comment on Code/Standard – Gaps
	SGMF TGN06-05 Ver1.0 Gas as a marine fuel: recommendations for linked emergency shutdown (ESD) arrangements for LNG bunkering; May 2019	
	IMO STCW Convention	- Regulation for training of crew for IGF Code ships exists under STCW Convention. Questions remain on the application of hydrogen under IGF Code, but development of training courses and certification by flag Administrations is still required to enable crew certification for hydrogen as fuel under STCW.
	IACS UR M78 <i>Safety of Internal Combustion Engines Supplied with Low Pressure Gas</i>	- Does not cover high-pressure and cross-head (2-stroke slow speed) engines burning gas. - Does not cover other low-flashpoint fuels. - Could be updated to include all engine types and fuels in more general way
	IACS Recommendation No.146 <i>Risk assessment as required by the IGF Code.</i>	- Could be updated to include specific requirements for hydrogen
	ISM Code	Development of operational requirements under IGF Code, or Interim Guidelines, would facilitate operators undertaking obligations under ISM Code

### 3.6 Marine Regulation Conclusions

There is a lack of regulation for the use of hydrogen as a marine fuel at the national, regional and international levels. This imposes a direct barrier to adoption. However, there are established methods for approving ship designs using the risk-based 'alternative design' approval process. Furthermore, classification societies have introduced tentative rules and guidelines to facilitate the adoption of hydrogen-fuelled ships.

Marine and land-based regulations for the generation, storage, transport and use of hydrogen provide significant regulatory references to facilitate its application as a marine fuel.

The basket of measures introduced by the European Commission under the 'Fit-for-55' initiative, which includes revised and new regulations, directives and policy initiatives, signals a strong commitment from the EU to a decarbonised and sustainable future for shipping.

To move further down this pathway at international level, dedicated submissions from Parties to the MEPC and MSC (including associated sub-committees) could contribute and drive regulatory change on the safety and environmental fronts.

Support should be provided to the development of the industry requirements, guidance, recommendations and best-practice publications that will enable the application of hydrogen as a marine fuel. The experience gained from the application of LNG as a marine fuel provides a good example for this.

Specifically, these are the actions and regulatory gaps that may need to be addressed in the near term:

- Support the development under the IMO CCC sub-committee of interim guidelines for hydrogen as a marine fuel.
- Support the IGC Code review for greater harmonisation with the IGF Code and consider amendments that would enable the combustion of hydrogen cargoes.
- Encourage States to develop national training and certification programmes under the STCW Convention and Code.
- Develop guidance to help operators implement their obligations to the ISM Code.
- Prepare the amendments to Annex VI and the NO<sub>x</sub> Technical Code that would enable approval and certification to the relevant energy efficiency and NO<sub>x</sub> regulations, together with developing amendments to regulations 14 and 18 of Annex VI.

- Consider more amendments to Annex VI and the NO<sub>x</sub> Technical Code to introduce internal combustion engine limits for hydrogen.
- Request the IMO to task the ISO with developing a marine-fuel standard and relevant standards for gaseous and liquid hydrogen couplings and bunkering.
- Encourage IACS to develop Unified Requirements for machinery and equipment and recommendations for risk-assessment guidance under the IGF Code and hydrogen bunkering to reduce industry uncertainty and support the harmonised application of requirements for hydrogen as marine fuel.
- Encourage SGMF, IBIA and other industry stakeholders to develop their respective guidance and best-practice publications to support application of hydrogen as marine fuel.
- Further, producing hydrogen at large scale based on renewable energies such as wind or solar will lead to other potential environmental impacts as outlined in section 2.2.3, such as local changes to temperature equilibrium and fauna, underwater radiated and airborne noise that may harm biodiversity. Production of this energy will be local and thus national or regional regulations would apply to regulate these potential environmental effects. As renewable-energy production increases, and to avoid incentivising greater production of green energy in specific locations of the world due to lack of proper national and or regional regulations, it is important that these regulations to be standardised at an international level to prevent a lack of level playing fields, distribution inequalities and price unevenness.

## 4. Risk Assessment Using Hydrogen as Marine Fuel in Merchant ships

The safety regulations for the use of hydrogen as marine fuel are still under development, as described in the Section 3. As part of this study, a HAZID assessment was carried out for generic ship types to contribute to discussions regarding the safety and risk management for hydrogen-fuelled ships. This part of the study provides an analysis of key aspects of hydrogen safety for its use as marine fuel in various types of marine vessels and fuel system configurations. Three types of fuel system configurations were considered to develop this study.

- H<sub>2</sub>-Fuelled Ro-Pax Vessel (with a compressed H<sub>2</sub> tank and fuel supply system)
- H<sub>2</sub>-Fuelled Product Carrier (with a compressed H<sub>2</sub> system)
- CH<sub>4</sub>-to-H<sub>2</sub> conversion and H<sub>2</sub> use onboard Product Carrier, Ferry and Very Large Crude Carrier (VLCC)

The purpose of this study is to identify the potential major hazards relative to the operational configuration of a proposed Hydrogen-fuelled vessel at an early stage of concept development, review the effectiveness of selected safety measures and, where required, expand them to achieve tolerable levels of residual risk.

Early identification and assessment of hazards can provide essential input for concept development at a time when a change in the design has a minimal cost penalty. Typically, the potential problems are earmarked for action outside the actual workshop. In the context of this study, the outcomes will help the European Maritime Safety Agency (EMSA) in drafting recommendations to develop and adapt procedures and regulations. It will also provide further awareness about the hazards associated with the use of hydrogen as a marine fuel.

In that context, HAZID workshops were undertaken to evaluate and summarise key aspects of safety as it pertained to the installation of hydrogen onboard a vessel. These HAZIDs included participation from an ABS multi-disciplinary team, as well as shipowners, a shipyard, an engine manufacturer and a port operator.

### 4.1 Hydrogen Safety

Gaseous hydrogen is a non-toxic, non-corrosive, highly flammable and explosive gas with wide flammability limits, a low minimum ignition energy, a fast-burning velocity and burn with a nearly invisible flame. It is colourless, odourless, tasteless and does not support life (asphyxiant). Liquid hydrogen is transparent with a light blue tint, and it is non-corrosive. It is the smallest molecule in all the available fuel.

Although its mixture with air rapidly disperses into the atmosphere or deflagrates with a relatively weak impulse in an open space, its deflagration in a totally or partially confined space is accompanied by a severe pressure impulse and a potential transition to detonation. In a gaseous form, attention therefore must be paid to its the potential for leaks and its likely formation as a flammable mixture. Potential ignition sources need to be avoided and the right materials need to be used for the components exposed to hydrogen, especially in a confined space.

The same considerations apply to liquid hydrogen since they yield gaseous hydrogen either spontaneously or during process operation. Liquid hydrogen has hazards related to its low temperature, such as fast evaporation, line-blocking due to solidification of moisture and air, thermal stress, embrittlement of construction materials due to the cold and handlers' frostbite.

For the safe production, storage, transport, transfer and utilisation of hydrogen, these dangers must be considered. To deepen understanding of these issues, here are some elected thermophysical property data for the gaseous and liquid phases of hydrogen:

- The physical and thermodynamic properties of H<sub>2</sub> in Section 2.1.1 and Section 4.1.1.
- H<sub>2</sub> Classification per Globally Harmonised System of Classification and Labelling of Chemicals

- Appendix VI – H<sub>2</sub> Classification per GHS

The sections that follow apply to all three HAZIDs; the specific assumptions and HAZID results for each vessel type are reported in Section 4.3. A detailed list of H<sub>2</sub> hazards is listed in Section 4.2.6 in Table 27, Table 28 and Table 29.

#### 4.1.1 Physical and Thermodynamic Properties of H<sub>2</sub>

Table 27. Selected safety related physical and thermophysical properties of H<sub>2</sub>

Property	Value
<b>Property at Normal Temperature and Pressure</b>	
Density	14.33 Kg/m <sup>3</sup>
Specific heat at constant pressure (C <sub>p</sub> )	14.33 kJ/kg.K
Specific Heat Ration (C <sub>p</sub> /C <sub>v</sub> )	1.416
Enthalpy	4129.1 kJ/kg
Viscosity	8.81 μPa.s
Thermal Conductivity	183.8 mW/m.K
<b>Properties at Critical Point (CP)</b>	
Temperature	33.19 K
Pressure (absolute)	1315 Kpa
Density	30.12 kg/m <sup>3</sup>
Viscosity	3.5 μPa.s
Thermal Conductivity	Very large
<b>Properties at Normal Boiling Point</b>	
Temperature	20.93 K
Pressure (absolute)	101.325 kPa
Density	1.33 kg/m <sup>3</sup> (vapour phase) 70.96 kg/m <sup>3</sup> (Liquid Phase)
Viscosity	1.1 μPa.s (Vapour Phase) 13.2 μPa.s (Liquid Phase)
<b>Properties at Triple Point</b>	
Temperature	13.957 K
Pressure	7.205 kPa
Density	0.1298 kg/m <sup>3</sup> (Vapour Phase) 77.21 kg/m <sup>3</sup> (Liquid Phase) 86.71 kg/m <sup>3</sup> (Solid Phase)
Viscosity	0.74 μPa.s (Vapour Phase) 26.0 μPa.s (Liquid Phase)
<b>Other Property</b>	
Diffusion Coefficient in Normal Temperature and Pressure (NTP) air 10 <sup>-4</sup> m <sup>2</sup> /s	0.61 X10 <sup>-4</sup> m <sup>2</sup> /s
Joule-Thomson maximum inversion temperature	200 K
Equivalent volume gas at NTP/volume liquid normal boiling point	847.1

Table 28. Safety related combustion property of Hydrogen

Property	Value
Flammability limits vol fraction %	3,6 to 76,6 (in NTP air,[1] Method T) 4,2 ... 77,0 (in NTP air,[1] method B) 3,75 ... 75,1 (in NTP air,[2]) 4,1 ... 94 (in NTP oxygen)
Stoichiometric concentration in air, vol fraction, %	29.53
Ignition energy (minimum) for ignition in air	0.017 mJ
Auto-ignition temperature	858 K
Thermal energy radiated from flame to surroundings(%)	17 to 25
Maximum laminar burning speed in NTP air, m/s	2.65 to 3.25 m/s
Maximum deflagration propagation speed in a stoichiometric NTP H <sub>2</sub> /air mixture, m/s	975 m/s
Detonation propagation speed in NTP air, m/s	1,480 to 2, °150 m/s
Burning rate of spilled liquid pool, mm/s	0.5 to 1.1 mm/s
Limiting oxygen index, vol fraction, %	5.0

Notes:

1 : EN 1839: Determination of the explosion limits of gases and vapours

2 : ASTM E681-09: Standard Test Method for Concentration Limits of Flammability of Chemicals (Vapors and Gases)

Table 29. Comparison with Other Common Gas

Gas	Hydrogen (H <sub>2</sub> )	Helium (He)	Methane (CH <sub>4</sub> )	Nitrogen (N <sub>2</sub> )
Boiling Temperature K	20.3	4.2	111.6	77.3
Liquid Density kg/m <sup>3</sup> at boiling point	70.8	125	422.5	808.6
Gas Density kg/m <sup>3</sup> at boiling point	1.34	16.89	1.82	4.53
Density at 20°C and 100 kPa kg/m <sup>3</sup>	0.0827	0.1640	0.6594	1.1496
Viscosity at 20°C and 100 kPa μPa.s	8.814	19.609	11.023	17.639
Diffusion Coefficient in air 10 <sup>-4</sup> m <sup>2</sup> /s	0.61	0.57	0.16	0.2
Lower Heating Value MJ/kg	119.93	n/a	50.02	n/a



Table 30. Property comparison Hydrogen and Methane

Property	Hydrogen	Methane
Molecular weight	2.016	16.043
NBP(a) temperature (K)	20.268	111.632
Density of liquid at NBP (kg/ m <sup>3</sup> )	70.8	422.6
Density of gas at NTP(b) (kg m <sup>-3</sup> )	0.0838	0.6512
Heat of vapourisation (kJ/kg)	445.59	509.88
Steady state vapourisation rates of liquid pools without burning (cm/min)	205 – 5.0	0.05 to 0.05
Heat of combustion (low) (MJ/ kg)	119.93	50.02
Heat of combustion (high) (MJ/ kg)	141.86	55.53
Diffusion coefficient in still air at NTP (cm <sup>2</sup> /s)	0.61	0.16
Diffusion velocity in air at NTP (cm/s)	<2.00	<0.51
Buoyant velocity in air at NTP (m/s)	1.2 – 9	0.8 - 6
Viscosity of gas at NTP (g/ cm.s)	8.9 x 10 <sup>-5</sup>	11.17 x 10 <sup>-5</sup>
Stoichiometric composition in air(c) (%)	29.53	9.48
Flammability range (limits) in air(c) (%)	4.1 – 75	5.3 – 15
Limiting oxygen index (c) (%)	5.0	12.1
Minimum ignition energy (mJ)	0.02	0.29
Minimum self-ignition temperature(d) (K)	858	813
Hot air-jet ignition temperature(e) (K)	943	1493
Adiabatic flame temperature in air (K)	2318	2158
Burning velocity in air at NTP (cm/s)	265 -325	37 - 45
Thermal energy radiated from flame to surroundings (%)	17 – 25	23 - 33
Quenching gap at NTP (mm)	0.6	2
Maximum experimental safe gap in air at NTP (mm)	0.08	1.2
Detonability range in air (c) (%)	18 – 59	6.3 – 13.5
Detonation velocity in air at NTP (km/ s)	1.48 – 2.15	1.39 – 1.64

Property	Hydrogen	Methane
Energy of explosion of fuel (MJ/ kg)	<110	<51
Energy of explosion of fuel(f)	<24	<11
Energy of explosion of gaseous fuel (b) (MJ/m <sup>3</sup> )	9.9	32.2

Notes:

a) NBP = normal boiling point

b) NTP = normal temperature and pressure (293.15 K, 0.1013 MPa).

c) in a volumetric ratio.

d) a stoichiometric mixture.

e) pure fuel vapour at NTP and a jet diameter of 4 mm.

f) in a trinitrotoluene TNT to fuel mass ratio

#### 4.1.2 Safety Considerations for the Use of Gaseous and Liquid Hydrogen

The properties of hydrogen and their associated potential hazards provides insights into its safety issues. While concerns about combustion hazards are common to all hydrogen systems -- whether the hydrogen is used as a liquid or a high-pressure gas or in a solid material as a hydride -- has a large impact on these hazards. Some general safety-related properties of gaseous and liquid hydrogen are discussed below.

The primary hazards and issues associated with hydrogen systems can be categorised and prioritised as follows:

- Flammability:
  - Thermal effects
- Pressure effects
- Easy ignitability of mixtures with oxidant
- Small size of the molecule:
  - Low viscosity
  - High diffusion rate
  - High buoyancy
- Interactions with materials (embrittlement of certain metals):
- Asphyxiation hazard if oxygen is replaced
- Hazards associated with the storage procedure:
  - Elevated storage pressure for gas
  - Low temperature for cryogenic liquid
  - Others for other methods, such as metal hydrides

This list simply highlights where concern should be focused in the design and operation of hydrogen systems. It does not detail specific hazards, or the possibility that different elements within the list can act together to form an overall hazard. These hazards and issues should be considered when evaluating hydrogen hazards.

Some of the properties mentioned above can either increase or reduce the hazard of a specific situation, depending on the circumstances. The high diffusivity of hydrogen gas means that a mixture cloud will expand quickly in all directions (including downward) to reach ignition sources. At the same time, it may dilute and become unreactive, if the accumulation of hydrogen is excluded.

While the rapid diffusion of hydrogen may dilute a cloud of escaped gas in air, this should not be taken for granted. Under most conditions, a release of hydrogen will result in a fluid dynamic motion that will dominate the transport and keep the hydrogen from diffusing away from the jet. In the case of a buoyancy-driven flow, the ensuing fluid dynamics will form a rapidly rising turbulent plume that will dominate the diffusion process. Likewise, in a release of hydrogen from a pressure vessel where the pressure is greater than 0,2 MPa (two atmospheres), the jet will be the

result of a choked flow and again the fluid dynamics will dominate the molecular diffusion and buoyancy effects of hydrogen.

### 4.1.3 Combustion Property

Flammability limits, ignition energy, auto ignition temperature and combustion property are considered to be the most important factors in the hazards associated with hydrogen systems.

A hydrogen-air flame is colourless; any visibility is caused by impurities. At reduced pressures, a pale blue or purple flame may be present. Severe burns have been inflicted on people exposed to hydrogen flames that result from the ignition escaped gas.

The temperature of the flame varies according to the mixture content of the combustion reaction. In general, it is very high and can cause severe burns.

Emissivity of hydrogen flame is lower than other hydrocarbon flames.

#### 4.1.3.1 Ignition

Due to the exceptionally low ignition energy required for combustion and the very wide range of flammability, strategies that control ignition sources are the most effective ways to improve safety. Table 31 lists potential ignition sources that need to be eliminated to prevent fire and explosions from H<sub>2</sub> release.

Table 31. Potential Ignition Sources

Electrical Source	Mechanical Source	Thermal Source	Chemical Source
Static discharge	Mechanical impact	Open flame	Catalysts
Static electricity (two-phase flow, for example)	Tensile rupture	Hot surface	Reactants
Static electricity (e.g., flow with solid particles included)	Friction and galling	Personnel smoking	
Electric arc	Mechanical vibration	Welding	
Lightning	Metal fracture	Exhaust from combustion engine	
Charge accumulation		Resonance ignition	
Electric charge generated by equipment operation		Explosive charge	
Electrical short circuits		High-velocity jet heating	
Electrical sparks		Shock wave from tank rupture	
Clothing (static electricity)		Fragment from bursting tank	

*Note: This is most common list of ignition sources. There are many other sources and all need to be accounted for in the design of the associated facilities/systems.*

*Source: ANSI/AIAA G-095A-2017 – Guide to Safety of Hydrogen and Hydrogen Systems*

#### 4.1.3.2 Ignition Energy

Hydrogen requires very low ignition energy compared to other hydrocarbons. The energy required for ignition decreases as the mixture of fuel and oxidiser approaches stoichiometry and increases as the mixture pressure decreases below ambient pressure. The MIE (minimum ignition energy) defines the most easily ignitable

concentration of fuel in air. MIEs for the ignition of hydrogen in air at 1 atmosphere are shown in Table 28 and Table 30.

#### 4.1.3.3 Flammability Limit

Hydrogen has a very high flammability limit; that poses a very high risk, combined with very low ignition energy requirement. Ignition sources typically ignored for hydrocarbon-based fuels and other applications have the potential to become key ignition sources in hydrogen applications. Table 31 lists known ignition sources that need to be considered for hydrogen applications. Please note that there may be additional sources, depending on the application.

#### 4.1.3.4 Flame Propagation

The principal hazard presented by hydrogen systems is the uncontrolled combustion of accidentally released hydrogen. Due to its small molecule size, the potential is high for leaks and the formation of combustible mixtures. Also, hydrogen's flame speed is much higher than other gases and can reach sonic velocity in certain circumstances. The ease of ignition associated with these mixtures combined with their high flame speeds increases the potential for high-energy releases that can occur as fires, deflagration and/or detonation.

### 4.1.4 Dispersion

Hydrogen possesses higher buoyancy and greater diffusivity than other gases. Under normal temperature and pressure (NTP) conditions, hydrogen is approximately 14 times less dense than air, making it the lightest of all gases. The small size of the hydrogen molecule gives it a diffusivity greater than helium and approximately three times that of nitrogen in air, at ambient conditions. Gaseous hydrogen also readily diffuses into solids.

In the case of gaseous hydrogen leaks, the effects of fluid dynamics (such as wind, momentum, or buoyancy-controlled flows) can dominate molecular diffusion. The buoyancy of hydrogen when it is allowed to rise will create convection currents. Because of these properties, hydrogen gas tends to disperse and diffuse and form ignitable mixtures with air.

In an unconfined atmosphere, these mixtures ultimately dilute to a level below the lower flammability limit (LFL). But it should not be taken for granted that this will happen very quickly; boundary conditions can have a strong effect. Caution also should be used in applying these observations when hydrogen vapours are released at cryogenic temperatures. Hydrogen vapours at temperatures of 23 K or lower are denser than NTP air. Usually, the condensation of atmospheric moisture also will add water to the mixture cloud, making it visible and increasing the density.

### 4.1.5 Viscosity

Hydrogen's low viscosity (8.81  $\mu\text{Pa} \cdot \text{s}$  at NTP) and small molecular size allow it to pass through porous materials, fittings, seals and small cracks more readily than other fluids. The low viscosity of hydrogen, another effect of the small size of the molecule, causes a comparatively high flow rate when it leaks through porous materials, fittings or seals. This effect is offset to some extent by the low energy density of the hydrogen gas compared to other flammable gases.

### 4.1.6 Gaseous Heat Capacity, Thermal Conductivity and the Joule-Thomson Coefficient

On a molar basis, the heat capacity of hydrogen is similar to other diatomic gases despite its low molecular mass. The thermal conductivity of hydrogen is significantly higher than other gases.

In a Joule-Thomson process (isenthalpic expansion) starting at ambient temperature, the temperature of hydrogen will rise. However, the rise is not sufficient to cause ignition. The maximum inversion temperature for hydrogen is 202 K ( $-96^\circ\text{F}$ ) at an absolute pressure of zero (Walker, 1983); consequently, at any temperature and pressure condition greater than this, the temperature of hydrogen increases upon expansion.

### 4.1.7 Hydrogen Embrittlement and Attack

Due to the small atom size, hydrogen atoms can permeate into the lattice structure of materials, which leads to significant loss of material ductility. The material degradation caused by embrittlement can result in a catastrophic failure of the containment structures, so informed material selection is a keyway to minimise the risk of failure.

## 4.2 HAZID Objectives, Process, Scope and Assumption

This section explains the common objectives, methods and scope, etc., for all vessel types in the study.

### 4.2.1 Objectives

The preliminary objectives of the HAZID study were to identify the risks of using hydrogen as a marine fuel for the Ro-Pax, product carrier and CH<sub>4</sub>-to-H<sub>2</sub> technology used on the ships; its use at the conceptual stage of design development also will help to satisfy the intent of the goals and functional requirements identified in the IMO IGF Code. The objectives were to:

- identify potential and new hazards introduced by hydrogen that require mitigation
- determine the potential consequences of the hazards
- identify safeguards for hazard prevention, control or mitigation (including safeguards for each stage of the project)
- propose recommendations to eliminate, prevent, control or mitigate hazards.
- provide early safety and risk considerations for design and safety-management requirements
- provide a clear framework for future safety-assessment studies that will help to anticipate major accidents
- compare this safety performance with the current practice under IGF code

The outcome of the exercise is the creation of a hazard register for owners of each vessel type to consider. This will include:

- Potential hazardous scenarios, including causes, consequences and existing safeguards
- The risks inherent in each scenario being evaluated according to the severity and likelihood of the consequence
- Identification of opportunities to improve design or risk-mitigation measures to reduce the estimated safety risks

### 4.2.2 Common Scope

It is assumed that all vessel types are in full compliance with regulatory and classification requirements; it is also assumed that they are in compliance with the requirements of the IGF code, except those related to H<sub>2</sub>, which will require a further risk study (those have yet to be fully developed by the IMO and other administrative bodies).

The scope of this assessment looks at almost all aspects of the vessels, with specific focus on the interaction between vessel systems, based on the information available for each type. It will include the:

- Hydrogen storage and vapour-/pressure-management system
- Venting and ventilation arrangements
- Engine room and machinery spaces
- Hydrogen-consumption equipment
- Hydrogen fuel-supply and return system.

The HAZID study covers the following areas (as applicable):

- General arrangement of vessels
- H<sub>2</sub> fuel-storage arrangement and details
- H<sub>2</sub> fuel supply and vapour-handling system, from fuel storage to machinery spaces
- H<sub>2</sub> fuel arrangement in fuel handling room and engine room
- General arrangement of the fuel-handling and engine rooms, including their ventilation
- Main engine safety concepts and vessel integration
- Hazardous area classification plans
- Ventilation and vents for stored H<sub>2</sub> fuel, fuel-supply system, machinery space and hydrogen consumer
- H<sub>2</sub> fuel-bunkering arrangement
- Safety systems
- Gas detection and firefighting arrangement
- Arrangements to purge or make H<sub>2</sub> inert
- Cargo storage and its impact
- Bunkering
- Emergency Escape and Rescue

#### 4.2.3 HAZID Workshop Methodology

A HAZID assessment is an extremely useful tool for performing high-level risk assessments of specific systems. ABS has used this approach in numerous risk-assessment projects, as a standalone analysis and to compare similar situations.

A HAZID workshop was held via video-conference. After the workshop, a brief review was conducted with the participants. A flow diagram for the overall HAZID process is shown in Figure 27 below.

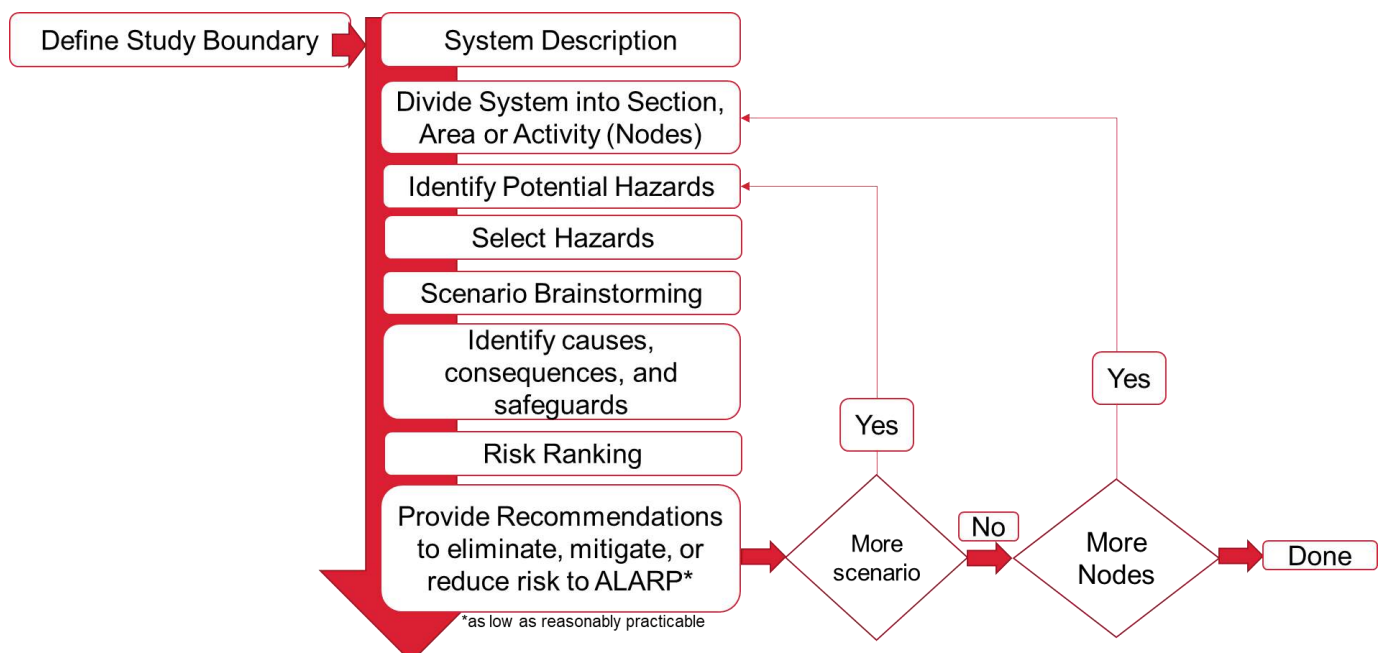

Figure 27. HAZID Process

During the workshop, a facilitator guided subject-matter experts through a structured discussion to identify and risk-rank the hazards. Participants were asked to provide input on preloaded scenarios (e.g., modifying, adding or removing risk scenarios) within the hazard register, as well as to discuss the location of the scenario on a risk matrix.

These discussions guided the focus areas, nodes and hazards to be considered before the study could be considered complete.

HAZID team members used a workshop environment to identify and analyse the boundaries of the study and to brainstorm potential 'what if' scenarios in a node. For clarity, a 'node' is a clearly defined, manageable section or system to be discussed in the brainstorming activity. 'Guidewords' are a set of conditions, such as "high pressure" or "vessel collision", that help to streamline brainstorming activity and identify potential hazards. Guidewords and sub-categorisations were used to identify the potential threats and the controls that could be used to limit or prevent their impact. Where required, recommendations were generated.

The HAZID analysis was conducted in sessions, which individually addressed each arrangement, process and operation on the ships.

#### 4.2.4 Limitations

The risk assessment was limited to a "simplified HAZID" analysis following the methodology described in this section. In most cases, the use of hydrogen as fuel is at the concept-development stage, making HAZID the most appropriate way to identify the risks.

This high-level concept provides a baseline to identify H<sub>2</sub> hazards and risks and to develop recommendations. Design variations such as the location of fuel tanks, venting and relief arrangements were considered for the baselines, but an evaluation of how those variations increased or lowered the general risk environment relative to the base case was not undertaken.

The workshop team identified several significant hazards related to the nodes for the systems analysed in this study. There may be other hazards that are not included, so further safety assessments should be conducted for each vessel due to toxicity risks, which are greatly impacted by general arrangement and the type of each asset.

##### **Limitations of the Ro-Pax concept**

For the Ro-Pax concept, the installation case for two fuel arrangements were considered.

1. A tank on an open deck starboard side
2. A tank below the vehicle deck in an enclosed space

Both cases consider only pressurised H<sub>2</sub> storage in ISO 19881:2018 type IV Carbon Composite Pressure Vessel (CCPV) with high-density polyethylene (HDPE) liner.<sup>19</sup>

However, alternate liquefied H<sub>2</sub> storage tanks were not considered at this stage; Similarly, steel storage tanks were not considered due to weight restriction and available sizes.

##### **Limitations of the Product Carrier Concept**

For the product carrier design concept, the proposed location of the hydrogen fuel tanks above the cargo tank on the deck would provide an efficient use of vessel space and such open space concept would also allow for hydrogen to disperse upward in case of a leak, thus reducing potential hydrogen-related risks. It leads to a risk of cargo tank fire/explosion and may consequently lead to H<sub>2</sub> leak/releases issues; in contrast, other options, such as storage being

---

<sup>19</sup> Composite tanks come in many variations and from many manufacturers. The most common ones are:

1. Mostly metal with some fibre overwrap in the hoop direction, mostly steel or aluminium with a glass fibre composite. The metal vessel and composites share equal structural loading.
2. Metal liner with a full-composite overwrap, generally aluminium, with a carbon fibre composite. The composites carry the structural loads.
3. An all-composite construction, polymer (typically high-density polyethylene or HDPE) liner with carbon fibre or hybrid carbon/glass fibre composite.
4. The composites carry all the structural loads. Linerless, all-composite construction. The tanks maximum storage capacity is of 50m<sup>3</sup>.

placed under deck, sacrificing one cargo hold, or using liquid H<sub>2</sub> storage in vacuum insulated tank were also examined. Fuel tanks located inside the cargo block could provide better protection for the fuel tank itself but can have additional concerns associated with an enclosed location.

However, alternate IMO IGC Code Type C (pressurised/refrigerated) independent tanks were not considered at this stage; they may offer a safer approach at the expense of an unknown volume of cargo space, and no similar projects had arisen in the market.

### **Limitations of the use of Onboard Methane-to-H<sub>2</sub> conversion for various ships**

In this concept developed by a client, methane is broken down into H<sub>2</sub> gas and solid carbon via a thermo-catalytic decomposition process using heat energy and catalysts to lower the temperature requirement and make the TCD more energy efficient.

The technology is proposed for various marine vessel types. For this HAZID, three vessel types were evaluated: a product carrier, ferry and very large crude carrier (VLCC). General arrangements of the three vessel types are shown in Figure 34. Chemical Carrier Application, Figure 35. Passenger Ferry Application (New construction) and Figure 36. VLCC Application.

Present technologies require the TCD technology to be installed in a containerised module onboard the ship and storage of produced carbon, creating some constraints associated with available space. Also, using a specific percentage of hydrogen in a gas engine will require further investigation by the engine manufacturer.

The proposed technology can be packaged in a standard high-cube ISO container onboard the vessel. This technology involves installing NG-to-H<sub>2</sub> system on a side stream of the natural gas fuel feed. A part of the total fuel feed is treated in the NG-to-H<sub>2</sub> system to remove carbon and the hydrogen-rich natural gas stream that is produced, called decomposition gas, is returned to vessels' fuel gas supply system (FGSS) and mixed with vapourised natural gas directly from LNG fuel storage tank. For example, by treating approximately 20% of the fuel stream in the NG-to-H<sub>2</sub> system, the client indicated that the vessel could reduce the CO<sub>2</sub> emissions below the level required by IMO in 2030, while using conventional LNG fuel.

## **4.2.5 Risk Ranking**

A risk matrix, found in Appendix VII – HAZID Risk Matrix, was used for a high-level evaluation of the risks from each hazardous scenario and their impact on personnel injury and disease, asset, environment and reputation. In selected cases where a scenario has multiple impacts -- such as environmental and personnel injury -- the study will document the "overall" impact. The process used to rank the risks included a:

- **Consequence review:** To identify the most credible worst outcome for each scenario, the team determined the outcome's location on the consequence axis.
- **Likelihood review:** The team determined the location of the undesired outcome along the frequency axis, considering the probability of failure for the preventive, detection and recovery safeguards designed to ensure that does not take place.
- **Risk:** The intersection of the likelihood and consequence ratings produces the risk level for that specific hazard scenario.
- **Action:** The risk ranking was used to help assess whether the current controls and safeguards are adequate; if not, additional safeguards/controls were identified to potentially reduce the risk (or identify areas where further review or analysis would be required to better understand the risk and potential mitigating measures) and recorded as 'actions' to be taken.

### **4.2.5.1 Grouping Systems/Areas for HAZID**

Drawings for each vessel HAZID were reviewed, while recognising the designs were at the preliminary stages and not all information was currently available. To derive maximum benefit, it was determined that the focus should be on GA-related issues (general arrangement) and operational aspects. In terms of system and areas, the following were considered (where applicable):



- General arrangement
- H<sub>2</sub> fuel storage/tank
- Bunkering arrangement
- H<sub>2</sub> fuel system/preparation room/arrangement
- Hazardous area plan
- H<sub>2</sub> supply system/vapour handling
- Engine room arrangement, safety concepts
- Ventilation and venting systems
- Safety systems: fire and gas detection, firefighting, Personal Protective Equipment (PPE)

#### 4.2.5.2 Modes of Operation

For this study, each mode of operation will be considered for the entire lifecycle of the vessel. The modes included (but were not limited to): bunkering, port departure, port entry, cargo loading/unloading in port, voyage (ballasted/loaded), standing by, maintenance, overhaul, emergency/upset situations, simultaneous operations, passenger loading/unloading in port and passenger volumes.

### 4.2.6 Hazards

The hazard scenarios used to help the team identify potential loss scenarios were categorised into primary groups: hydrogen-related general hazards, system-related hazards, external hazards and ship-related hazards. These are described in the following subsections.

#### 4.2.6.1 General Compressed H<sub>2</sub> Related Hazards

Discussion of hydrogen-related risks is an important part of the HAZID study as it forms the basis for design development and provides understanding to establish ALARP (as-low-as-reasonably-practicable) criteria. Hydrogen characteristics and hydrogen-related hazards are:

- Material – susceptibility for H<sub>2</sub> embrittlement
- Wide flammability 4-75%
- Higher flame speed
- Low ignition energy
- Lightest atom and highly buoyant
- Higher diffusivity
- Deflagration/Detonation, missile effect
- Smallest atom size leads to higher leak potential and migration through material atoms
- Clean burning, cannot see flame
- Compressed gas (pressure)
- Asphyxiation
- Fire and Explosion
- Low viscosity

#### 4.2.6.2 System Hazards

Pertaining to the systems used to manage hydrogen, the following hazards are considered in the analysis:

- **Process Hazards:** such as those related to NH<sub>3</sub>/boil-off gas and other flammable/toxic fluids, e.g., the release of flammable inventory (for each area of the system), ruptures and start-up/shutdown issues.
- **Utility Hazards:** such as those related to fire and water systems, fuel oil, heating/cooling mediums, power supply, drains/sumps, air, nitrogen, chemical injections, etc.
- **Venting:** Normal and abnormal
- **Maintenance Hazards:** such as those related to maintenance culture and provisions for safe maintenance, etc.
- **SIMOPS:** such as those related to cargo operations loading/unloading, bunkering, supply, etc.
- **Interface Issues:** such as those related to process, instrumentation, utilities or structural elements, etc.

- **Emergency Response:** such as those related to access/egress areas, communication (alarms [audible/visual], call-points, CCTV, radio) and fixed/portable firefighting equipment.
- **Any other hazards:** such as those related to lifting operations, structural failure, rotating machinery, cold/hot surfaces, etc.
- Any other issues or items of concern that were raised during the workshops.

#### 4.2.6.3 External Hazards

Consideration of other external hazards included:

- Cargo
- Dropped objects
- External fires
- Water ingress
- Physical damage
- Smoke
- Temperature
- Lightning
- Humidity
- Collision
- Grounding
- Mooring hazards
- Weather
- Storm
- Wind
- Wave
- Current

#### 4.2.6.4 Ship-Applicable Hazards

Other ship-applicable hazards were also considered under the definition of **Global Hazards**:

- **Natural and Environmental Hazards:** climatic extremes, lightning, seismic events, erosion, subsidence, etc.
- **Movement/Floatation Hazards:** grounding, collision, etc.
- **Effect of Facility on Surroundings:** proximity to adjacent installations, proximity to transport, proximity to population, etc.
- **Effect of Man-Made Hazards:** - security hazards, social/political unrest, etc.
- **Infrastructure:** communication, supply support, mutual aid, emergency services, etc.
- **Environmental Damage:** discharges to air/water, emergency discharges, water disposal, etc.
- **Product Hazards:** oil
- **Health Hazards:** disease, carcinogens, toxic effects, occupational hazards, etc.

#### 4.2.6.5 Common Failure Causes

##### 4.2.6.5.1 Equipment Failure Cause

- Wear and tear
- Erosion
- Stress and Strain
- Fatigue
- Corrosion
- Collision
- Grounding
- Impact
- Fire

#### 4.2.6.5.2 Failure of Process Control – operating outside of design

- Temperature high/low
- Pressure high/low
- Flow: high/low/reversed/ no flow
- Level high/low
- Loss of power

### 4.2.7 General Assumptions – Applicable to all HAZID Studies

There were several critical assumptions made for the workshops. They were based on current documentation, and some were deemed of such importance to be considered ‘assumptions’ rather than ‘recommendations’. Most were considered ‘safeguards’ in the workshop records. The most common critical assumptions are listed below. Any assumption specifically applicable to a particular vessel type was listed within its HAZID section.

- The vessel will be designed and built-in compliance with class and statutory regulations.
- Fuel storage, preparation, supply and venting will all comply with the requirements of IMO IGF Code, except those where the H<sub>2</sub> requirements differed from the IGF Code (for reasons previously mentioned).
- As far as practical, the H<sub>2</sub> fuel system will be designed to not release H<sub>2</sub> into the atmosphere during normal operational conditions. H<sub>2</sub> may be released during emergency conditions.
- The capacity of any relief valves will be in line with requirements from the IGF Code and ABS Rules.
- All releases through the relief valves will release to a single-vent mast or multiple vents, considering high-pressure, low-pressure, high-flow releases, etc.
- Hydrogen bunkering will be undertaken at anchorage, jetty or port, using a hydrogen bunker barge or vessel in a side-by-side configuration using transfer hoses.
- Bunkering vessels will have fenders and hoses, so the vessels themselves will not carry this equipment.
- Cargo operations and bunkering will not occur simultaneously.
- During gas shutdowns, nitrogen or helium will purge the fuel lines.
- Heating and cooling systems for fuel have an intermediate circuit to avoid any contamination of the ship’s cooling water.
- The intermediate heating/cooling circuit will use a water/glycol medium.
- The bunker system will have a single supply line considering hydrogen is stored in compressed condition.
- H<sub>2</sub> will be stored in ISO CCPV with HDPE liner.
- Pressure reduction of H<sub>2</sub> will be done in multiple stages.

## 4.3 HAZID Results – Findings and Recommendations

All high-level risks were considered and the safeguards required by codes/standards/regulation were identified; the risk rankings were developed and listed in the risk register’s appendix for the three vessel types. Due to very high flammability, high flame speed and small atom size, many risks and safeguards were identified and a significant proportion were additional to those normally required by the IGF Code. Because no codes were available, many of the study’s recommendations called for further analysis and research.

However, they were all listed for consideration and may help to inform future prescriptive requirements and to develop safer designs and arrangements. The recommendations are listed for each vessel in the appendix:

- Appendix VIII – List of Recommendations Ro-Pax
- Appendix X – List of Recommendations Product Carrier
- Appendix XII – List of Recommendations CH<sub>4</sub> to H<sub>2</sub> Technology

### 4.3.1 Summary of Important Recommendations:

A high-level summary of important recommendations which require further study and research is listed below.

1. Hydrogen is considered extremely flammable with very wide range that requires very low energy to ignite. Rules for hazard areas and security zones need to be developed.
2. A detailed gas-dispersion assessment to establish hazardous zones for H<sub>2</sub>-release scenarios is required.
3. Hazardous areas, safety and security zones need to be established and aligned with the unique behaviours, dispersion and ignition characteristics of Hydrogen.
4. Use of hydrogen on a commercial ship potentially increases the consequence of fire from H<sub>2</sub> or cargo. An installation-specific fire study should be conducted to address the risks and consequences of exposing an H<sub>2</sub> tank to high heat loads and fire.
5. The storage of hydrogen in Type C tanks next to accommodation should be further evaluated.
6. The location of hydrogen tanks on any commercial vessel should be evaluated with respect to collisions and groundings; current data suggests this event could occur relatively frequently. Damage to H<sub>2</sub> tanks could potentially have a significant impact on human safety and the asset's integrity; the data indicates that most of these events happen near harbours or close to shorelines. Emergency procedures need to be developed to address the risk of releasing H<sub>2</sub> and to establish transfer procedures if the tank is not damaged.
7. Emergency procedures need to be developed that address emergency fuel transfers or venting, when leaks occur after collisions and groundings, etc.
8. Due to relatively high pressure of fuel storage, additional safety measures need to be introduced to prevent the uncontrolled release of H<sub>2</sub> from storage tanks.
9. All piping and equipment should be designed to 'leak-before-breaking' criteria to minimise the potential for larger leaks.
10. Additional instruments and measures will be needed to detect H<sub>2</sub> leaks and fire, due to very wide flammability range and the fact that the H<sub>2</sub> flame is invisible.
11. In case of large leaks, additional safety measures will be needed to prevent loss of life.
12. Hydrogen-burning engines are in development, so their related hazards need to be identified by engine manufacturers and detailed failure mode, effects and criticality analyses (FMECA) for both the control system and the mechanical components) should be performed.
13. A detailed HAZOP study is recommended for the entire fuel system, supporting systems, interfaces, etc., to identify additional hazards. Hydrogen systems will need to be designed to minimise the possibility of fuel leaks.
14. An operational bunkering-safety study need to be conducted and new designs should help to mitigate any risks that may impact on the vessel and its fuel system.
15. A minimum hourly air-change rate needs to be established for ventilation of any space containing hydrogen based on arrangement and leak rates.
16. It is recommended that all inlet and outlet spaces containing hydrogen equipment be provided with a hydrogen detector.
17. All pressurised hydrogen containing systems/equipment to be leak tested using Helium or N<sub>2</sub> - 5% H<sub>2</sub> mixture.
18. For purging, gas freeing, gassing up etc., helium or N<sub>2</sub> should be used. Purity or inerting of inert gas are to use < 1% O<sub>2</sub> to avoid any internal deflagration/detonation potential.
19. Vent masts are to be designed to avoid any air entering the mast; alternatively, they need to be designed to withstand internal deflagration/detonation, considering pipe sizes, lengths and complexity.
20. Vent and pressure-relief systems are to consider factor or reverse flow, excessive back flow, discharge pressure for system, etc. Keep high-pressure, high-flow systems separate from low-pressure, low-flow systems.
21. Material selection needs to pay special attention to hydrogen-embrittlement issues.
22. For hydrogen services in high-temperature environments, 'hydrogen attacks' are to be consider in the criteria for material selections.
23. There is potential for deflagration to detonation transition (DDT) due to installations in confined spaces with many pipes and equipment. This creates an extremely high risk. Designs should consider such risks to minimise this potential. A special study needs to be conducted to understand these risks and to develop effective mitigation strategies.
24. Hydrogen systems should be designed so that inventory leaks from failures are minimised by zoning, isolation, blowdown, detection, etc.
25. Any enclosed space where hydrogen is present needs to be designed to prevent explosion by any means.
26. Experience has shown that human error is a major contributor to hydrogen system-related failure. It is recommended that human capabilities should be considered during design and operation.
27. Strong training programmes are to be developed and employees trained in all systems from design and operation to maintenance and management.
28. It is advised that safety features for hydrogen systems be redundant in cases where single safety features could cause a major hazard.
29. Hydrogen systems (for tanks, piping etc..) installed on an open deck should be protected against dropped objects and other mechanical hazards.

30. The planned and/or unplanned venting of hydrogen poses thermal hazards, due to possibility of fires in the vent stacks and thermal flashbacks. Heat-radiation analyses are recommended to establish worst-case discharges, exclusion zones and to protect any equipment and people potentially exposed to high heat radiation.

#### 4.4 Hydrogen-Fuelled Ro-Ro Passenger Ship

The proposed Ro-Ro is a concept design for a small EU Class C passenger ship. It is double ended Ro-Ro ferry that will provide emissions-free transit between Kirkwall and Shapinsay in the Orkney Islands. It is designed to make multiple trips between the two ports on a fixed route.

The ship's power will be generated primarily using PEM hydrogen fuel cells, with load sharing, peak shaving, augmentation and redundancy provided from Li-ion batteries. Hydrogen is stored in ISO CCPV with a HDPE liner at 250 bar or higher. The endurance is estimated to be approximately two days, with the batteries being recharged every night.

The ship will be emissions free, as power is to be provided by a combination of hydrogen fuel cells and lithium-ion batteries, which will provide propulsive power to two (2) Cycloidal Propulsors with integral electrical motors located in the port aft and starboard forward quarters.

The ferry has the capacity to carry 120 paying passengers. A maximum of 16 cars or two heavy-goods vehicles or combinations thereof. It will be manned by four crewmembers: a helmsman, a motorman and two deckhands.

The general arrangement for the vessel is provided in Figure 28. The ferry has a single main vehicle deck, which is accessed via ramps at the bow and stern of the ship, with a foot-passenger lounge on the starboard side. The ship will be controlled from a centrally located bridge. Two propulsion units, one forward and one aft, provide propulsive power and manoeuvring. Two different storage arrangements were considered for the fuel storage tanks:

- at the bridge deck level port side
- within the cargo hold below main deck at aft

The fuel cells are located within a dedicated space beneath the main deck. In case of loss, the power generated by the fuel cells is augmented or replaced by power from two Li-ion battery compartments, which are also located beneath the main deck in a separate compartment.

All venting of H<sub>2</sub> is via the vent mast on the port side at highest point on ferry. Between the pilot house and fuel tank is a blast wall.

There are two bunker stations port side: one on the open deck and one on the main deck (lower bunker station), which is semi-enclosed.

Bunkering to be done at bunker terminal via hose. Terminal to have dedicated H<sub>2</sub> storage and compressor to supply/bunker H<sub>2</sub> (see Figure 29).

The passenger and pilot house/bridge are on the starboard side.

##### 4.4.1 Principal Particulars

The ferry's key dimensions are listed below.

- Length overall (LOA): 40 metres
- Length between perpendiculars: 37.80 metres
- Breadth (moulded): 11.50 metres
- Breadth (over fenders): 1.90 metres
- Depth (main deck): 2.50 metres
- Draught (design): 1.60 metres
- Draught (scantling): TBC
- Air Draught (top of vent mast): 25 metres

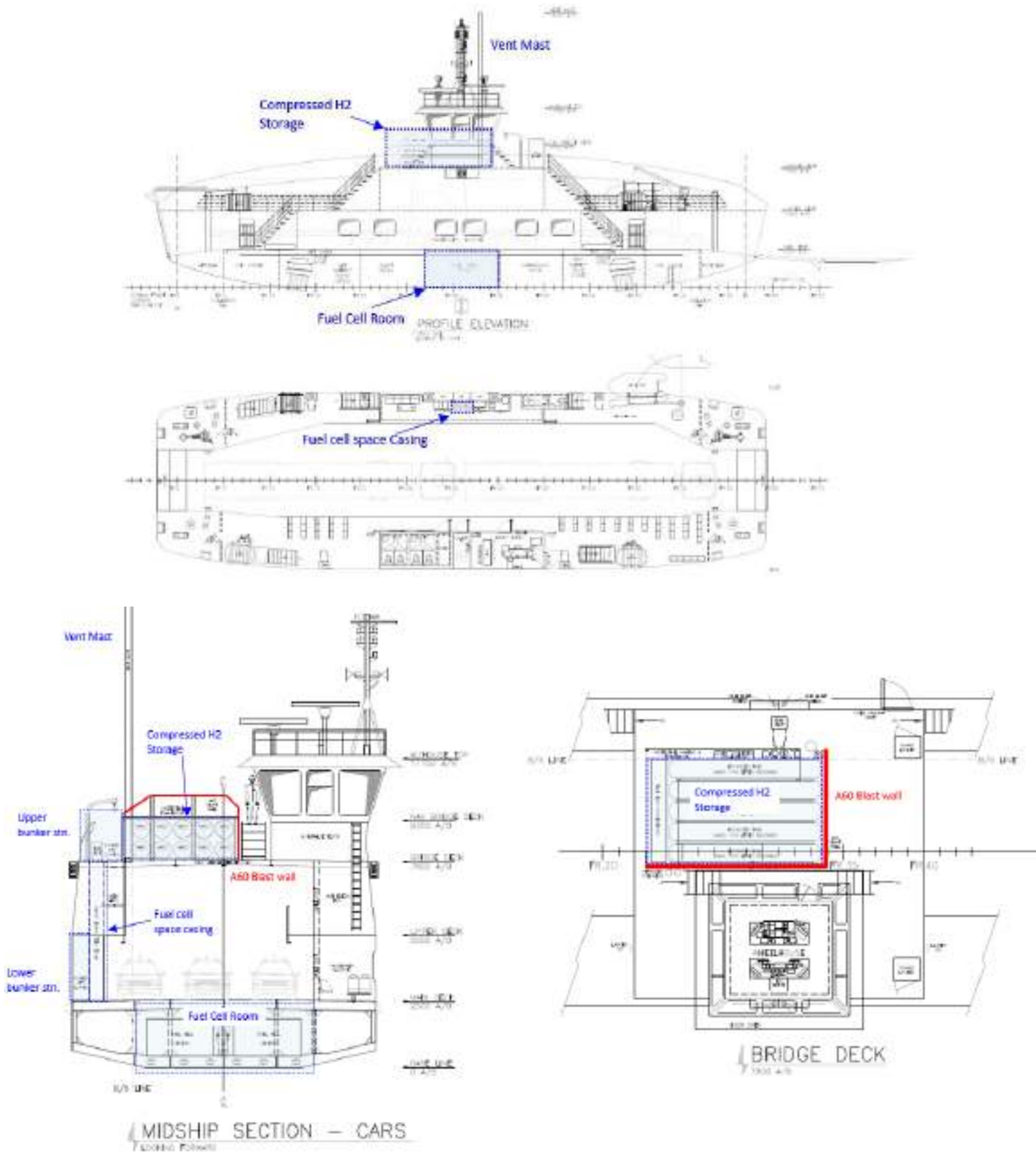

Figure 28: RO-RO Vessel General Arrangement

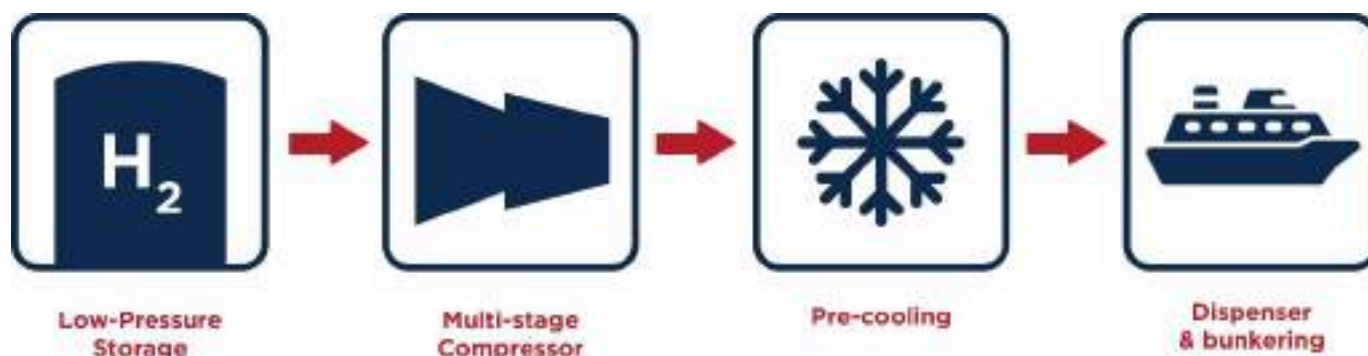

Figure 29: Hydrogen Bunkering

#### 4.4.2 Assumptions – Ro-Ro Passenger Ship

In addition to the assumptions listed in section 4.2.7, other assumptions from the workshop are listed below:

- Bunkering will be done at night or when there are no passengers or vehicles onboard.
- There is only one bunker line to load high-pressure H<sub>2</sub>. Bunker lines always will be kept at 20 bar during voyage.
- The bunkering infrastructure is outside of project scope, but the team considered a cascade filling approach to minimise temperature/pressure variations, while bunkering from onshore tanks via a multi-stage compressor and pre-cooling where needed.
- Pressure reduction for consumers will involve a two-stage pressure-reduction arrangement.
- High pressure pipework is limited to open deck, with pressure reducing stations located outside the enclosed space.
- Any H<sub>2</sub> piping in an enclosed space is double walled.
- All H<sub>2</sub> piping on an open deck is single walled.
- The ferry's route is fixed and involves multiple trips.
- Bunkering to be done at bunker terminal using hose

#### 4.4.3 Results and Recommendations

During the HAZID workshop, all high-level risks were considered, and the safeguards required by codes/standards/regulation were identified. Risk rankings were developed and are listed in Appendix IX – HAZID Register Ro-Pax.

Due to wide flammability range, the requirement for very low ignition energy, small molecular size, high flame velocity and high diffusivity and buoyancy, many risks and safeguards were identified; a significant proportion of these were additional to those required by IGF Code.

With few codes available, many recommendations called for further analysis and research. However, they were all listed for consideration and may help to inform prescriptive requirements, safer designs and arrangements. The recommendations developed by the team are listed in Appendix VIII – List of Recommendations Ro-Pax.

The recommendations from the HAZID study are listed in the HAZID register Appendix IX – HAZID Register Ro-Pax for all major nodes of the systems at the operational levels. Some 120 recommendations were documented in Appendix VIII – List of Recommendations Ro-Pax based on discussions with the participants in the preliminary HAZID study.

Table 32. Ro-Ro Vessel HAZID Risk Ranking Summary

Product Carrier HAZID Risk Profile					
Node #	Key system level HAZID nodes	Risk Ranking of Hazards Identified			
		Low	Moderate	High	Extreme
1	Upper Bunkering Station	6	30	16	1
2	Lower Bunker Station	1	8	13	-
3	Vessel General Arrangement	0	0	0	0
4	H <sub>2</sub> Storage System Location on Wheelhouse Deck (open) (Tanks, Tank Interface, Supports)	5	33	18	3
5	H <sub>2</sub> Storage System Location Below Deck (Tanks, Tank Interface, Supports)	6	31	16	3
6	H <sub>2</sub> Supply System & Piping	4	14	4	-
7	Fuel Cell System	-	-	-	-
8	Li-ion Battery System	-	-	-	-
9	Electrical System	-	-	-	-
10	Ventilation System (H <sub>2</sub> Storage, Fuel Cell Room, Battery Room)	-	-	-	-
11	Venting System & Vents	2	2	2	-
12	Cooling System	-	-	-	-
13	Safety System (ESD & Isolation, Pressure Relief, F&G Detection)	-	-	-	-
14	Firefighting Systems	-	-	-	-
15	Other Vessel Operations (SIMOPS, Hazards in Port)	-	-	2	-
16	Testing, Maintenance & Inspection	-	-	-	-
17	Emergency Escape, Evacuation and Rescue	-	-	1	-
18	Terminal Bunker Delivery	-	5	3	-
<b>Total</b>		<b>24</b>	<b>123</b>	<b>75</b>	<b>7</b>

The key findings and recommendations from the HAZID study and the additional risks that would need to be addressed for the Ro-Pax are summarised below:

- Bunkering operations will pose significant risks to passengers if they are performed while passengers are onboard or during vehicle loading. Additional risk studies, such as bunkering operation HAZID/HAZOP and dispersion analysis, must be conducted and additional measures put in place to minimise these risks.
- Dropped-object risks are significant when an H<sub>2</sub> tank and piping are placed on deck. No overhead lifting should be allowed above the area of the tank, and the risks of falling objects from bridges, or from a port's lifting equipment are to be considered and mitigated. An assessment of the risks from dropped objects is to be performed and protection arrangements considered.
- Collision/grounding can pose significant risks to the integrity of the H<sub>2</sub> tanks if they are installed near the bottom of the vessels in an enclosed space. While the arrangement of the fuel tanks complies with the IGF Code, it needs to be re-evaluated to consider the risk to passengers and assets.
- No open H<sub>2</sub> piping should be allowed in any area where there is passenger or vehicle traffic. Most piping should be run in ducted or double-wall configurations and the annulus should be vented at a safe location.
- An emergency evacuation and rescue study should be performed to consider worst-case scenarios considering H<sub>2</sub> leaks or vehicle fires.



- CCPV tanks protection against fire/jet fire/explosion are to be further evaluated and appropriate thermal protection to be considered. As proposed, TRPD effectiveness can be compromised in conditions involving rain, ice build-up, water spray, etc.
- If exposed to low temperatures or ice build-up, etc., the impact on all hydrogen equipment, piping, valves and instruments will require further study.
- For H<sub>2</sub> tanks installed in enclosed spaces, further studies are to be conducted that examine the impact of smaller spaces, congestion, equipment density, etc.; these conditions can significantly impact on safety with respect to:
  - The maintainability of equipment, systems
  - Inspection and monitoring
  - Potential for deflagration to detonation
  - Asphyxiation
  - Hull damage
  - Water ingress
- For the terminal facility a detailed process safety hazard study needs to be conducted and process safety management are to be followed.

## 4.5 Hydrogen-Fuelled Product Carrier

The concept product carrier that burns hydrogen as its main marine fuel uses a dual-fuel medium-speed main propulsion and genset engine designed by the recognized engine manufacturer (ABC Anglo Belgian corporations). A general arrangement of the proposed product carrier is shown in Figure 30. General Arrangement of Product Carrier (below).

This is a typical 18,600 DWT product carrier (chemical and petroleum products). Main particulars of carrier:

- Length overall (LOA): 154 metres
- Length between perpendiculars: 150.10 metres
- Breadth (moulded): 23.75 metres
- Depth (moulded): 13.10 metres
- Draught (design): 9.35 metres
- Deadweight at 9.35m: 18,600 tonnes
- Cargo Oil Capacity: 22,700 m<sup>3</sup>

The concept uses CCPVs installed in an ISO frame to store H<sub>2</sub> at high pressure (250 bar). Tanks are installed on the weather deck port and starboard sides. Two bunker manifolds (port and starboard) will be installed between the oil-cargo manifold and the H<sub>2</sub> storage tanks forward of cargo manifold. There are 24 ISO frames containing the H<sub>2</sub> storage tanks giving the ship on its specific operational profile around seven days of endurance, though this includes significant time in port. ISO frames are open construction.

Forward of the ship, eight ISO frames will be installed on each of the port and starboard sides. Eight tanks will form one fuel tank. On the aft of ship, four ISO tanks on each of the port and starboard sides will be installed. Each of the four aft tanks will form one fuel tank. There are four fuel tanks for fuel-management purposes. From each tank, fuel will be piped to the fuel-preparation room (FPR) common manifold, from where pressure will be reduced in multi-stage production arrangement. After the pressure is reduced, the fuel will be distributed to each consumer Gas Valve Unit (GVU) separately via a separate pipe from common manifolds at the FPR after the pressure is reduced.

Master shut-off valves are installed at the FPR. Fuel piping from FPR to each consumer GVU is double-walled piping meeting the IGF Code requirement. Within the GVU, further pressure and supply management -- depending on the engine's load -- will be managed as per the requirements from the engine manufacturer. The piping system from GVU to engine is also all double-walled piping.

The installation of a FPR is proposed for the starboard side, forward of the accommodation and aft of the starboard H<sub>2</sub> storage tank.

The fuel piping from each fuel storage tank on the weather deck runs alongside the pipe trunk.

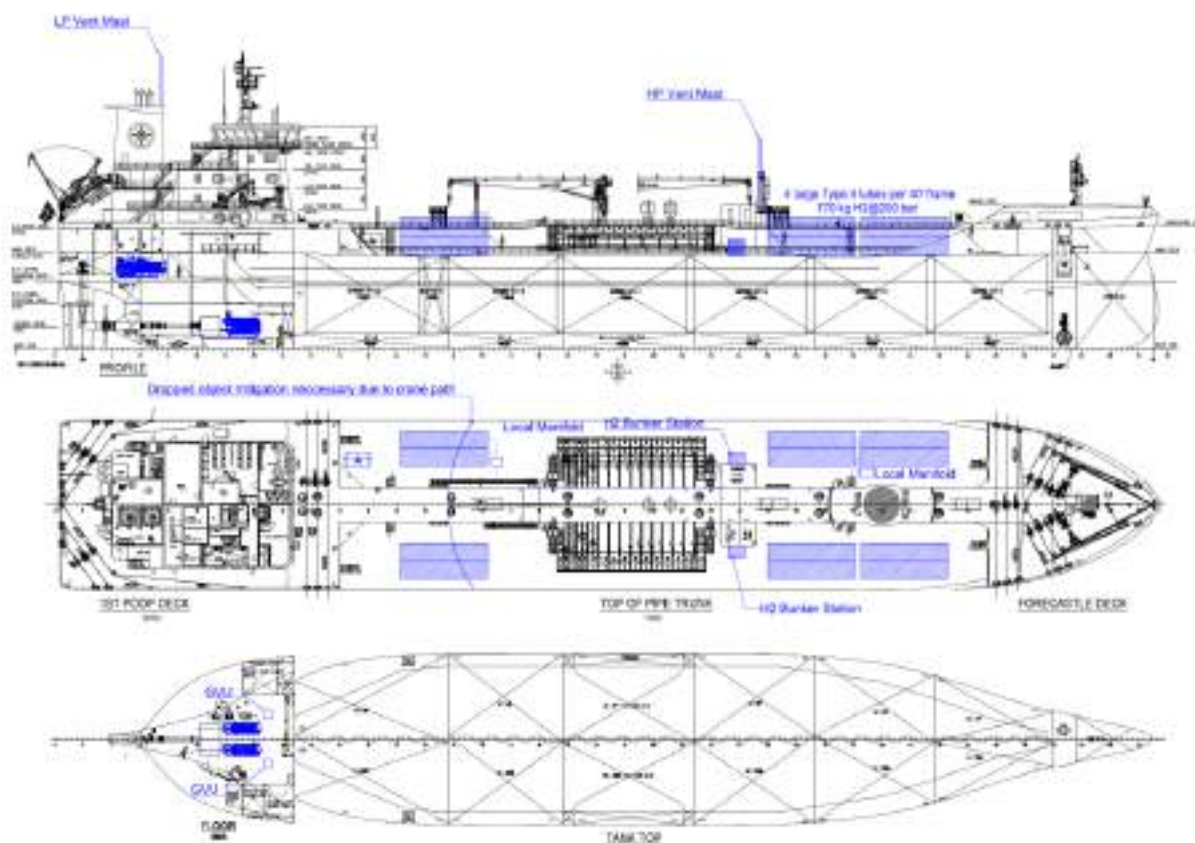

Figure 30. General Arrangement of Product Carrier

#### 4.5.1 Assumptions – Product Carrier

In addition to the assumptions listed in section 4.2.7, other assumptions from the workshop included:

- Bunkering and cargo transfers will not be done simultaneously.
- There is only one bunker line to load HP H<sub>2</sub>. The bunker line will be depressurised and purged after bunkering.
- Bunkering infrastructure was outside of the project scope, but the team considered a cascade filling approach to minimise variations in temperature and pressure.
- Pressure reduction for consumers will be done in two-stage pressure-reduction arrangement.
- Any H<sub>2</sub> piping in the engine room, or an enclosed space is double walled.
- All H<sub>2</sub> piping on the open deck is single walled.
- It is assumed that enough N<sub>2</sub> is available for H<sub>2</sub> system usage.
- CCPV tanks are designed and constructed as per ISO standard.

#### 4.5.2 Results and Recommendations

During the HAZID workshop, all high-level risks were considered, and the safeguards required by codes/standards/regulation were identified. Risk rankings were developed and are listed in Appendix XI – HAZID Register Product Carrier.

Due to the wide flammability range, very low requirements for ignition energy, the smallest atom size of the fuel, its high flame velocity, high diffusivity and buoyancy, many risks and safeguards were identified; a significant proportion of these were additional to those required by IGF Code. With few codes available, many recommendations were for further analysis and research. However, they are all listed for consideration and may help to inform prescriptive

requirements and safer designs and arrangements. The recommendations developed by the team are listed in Appendix X – List of Recommendations Product Carrier

The recommendations from the HAZID study are listed in the HAZID register Appendix XI – HAZID Register Product Carrier for all major nodes at the systems at the operational levels. Some 131 recommendations were documented in based on discussions with the participants in the preliminary HAZID study.

Table 33. Product Carrier HAZID Risk Ranking Summary

Product Carrier HAZID Risk Profile					
Node #	Key system level HAZID nodes	Risk Ranking of Hazards Identified			
		Low	Moderate	High	Extreme
1	Vessel General Arrangement	-	-	1	1
2	Bunker Station	12	38	68	2
3	Hydrogen Storage System	-	3	30	1
4	Hydrogen Tank Connections & System	-	-	1	-
5	Fuel-Preparation System	-	2	3	-
6	Hydrogen-Supply Piping	-	7	-	1
7	Engine	1	16	18	-
8	Genset	-	-	-	-
9	Ventilation System	-	1	5	-
10	Venting System & Vents	-	12	5	8
11	Safety System	-	-	-	-
12	Firefighting System	-	-	-	-
13	Other Operating Modes	-	-	-	-
14	Other Vessel Operations	-	-	8	-
15	Testing, Maintenance and Inspection	-	-	-	-
<b>Total</b>		<b>13</b>	<b>79</b>	<b>138</b>	<b>13</b>

The key findings and recommendations from the HAZID study and the additional risks that would need to be addressed for the product carrier are summarised below:

- Dropped-object risks are significant when an H<sub>2</sub> tanks and piping are placed on deck. No overhead lifting should be allowed above the area of the tank and the risk of falling objects from bridges or port lifting equipment is to be mitigated. An assessment of the risks from dropped objects is to be performed and protection considered.
- The protection of CCPV tanks against fires/jet fires/explosions should be further evaluated and the appropriate thermal protection considered. TRPD effectiveness can be compromised in case of rain, ice build-up, water spray, etc.
- If exposed to low temperatures or ice build-up, etc., on open decks, the impact on all hydrogen equipment, piping, valves and instruments will require further study.
- For operation in cold weather for ice-class vessel manifolds, instrument, valves etc., are to be placed in an enclosed space to provide additional protection.
- The risk of cargo fires is to be specifically considered for tanks located above the cargo tank and the appropriate mitigation provided; CCPV tanks can pose explosion risk if exposed to higher temperatures.
- The protection of CCPV tanks from jet fires from the area of the fuel-piping manifold will need to be further studied.
- Due to invisibility of H<sub>2</sub> fires, the possibility of small leak jet fires is to be further studied. As detection can be challenging, employees will need to be protected against for exposure.

- The number of tanks and connection/manifolding pose greater challenges to design, operation, maintenance etc., so more study of details associated with FMECA and HAZOP will be needed to identify all the risks.
- Keep high-flow/high-pressure vent line separate from low-flow/low-pressure vent lines.
- Vents systems/lines are to be designed to prevent air ingress and internal deflagration/detonation; if this is not possible, all vent lines/piping will need to be designed to withstand internal deflagration/detonation pressure surges.
- Gas dispersion, fire load and heat radiation analyses are to be conducted using various release scenarios.
- Engine FMECA and type testing is to be performed.
- Double-walled required piping if air is inerted; consider designing annulus to withstand deflagration/detonation loads.
- With many tanks and manifolds, the fuel-management philosophy will need to be developed further, as it can pose additional risks to the design and operation.

## 4.6 Hydrogen-Fuelled Ship Using CH<sub>4</sub> to H<sub>2</sub> Conversion Technology

In this concept developed by a client, methane (CH<sub>4</sub>) is broken down into H<sub>2</sub> gas and solid carbon via a thermo-catalytic decomposition process using heat energy and catalysts to lower the temperature requirement. The H<sub>2</sub> produced can be blended in existing dual fuel CH<sub>4</sub>-powered engine up to 20% (energy content). This reduces CO<sub>2</sub> emission as the process converts all carbon into solid carbon, which has an additional after-market value.

The technology could work on various marine vessel types. For this HAZID, three vessel types were evaluated: Product Carrier, Ferry and a Very Large Crude Carrier (VLCC). General arrangements of the three vessel types are shown in Figure 34. Chemical Carrier Application, Figure 35. Passenger Ferry Application (New construction) and Figure 36. VLCC Application.

The technology proposed can be packaged in separate enclosures onboard the vessels. It requires installing an NG-to-H<sub>2</sub> system on a side stream of the natural gas fuel feed. Part of the fuel feed is treated in an NG-to-H<sub>2</sub> system to remove carbon; the hydrogen rich natural gas stream this produces, called decomposition gas, is returned to vessels' FGSS and mixed with vapourised natural gas directly from the LNG fuel-storage tank.

For example, by treating approx. 20% of the fuel stream in the NG-to-H<sub>2</sub> system, the client indicates that the vessel can reduce the CO<sub>2</sub> emissions below the level required by IMO in 2030, while using conventional LNG fuel.

Figure 31 and Figure 32 show a System Isometric Diagram and general arrangement of the TCD system.

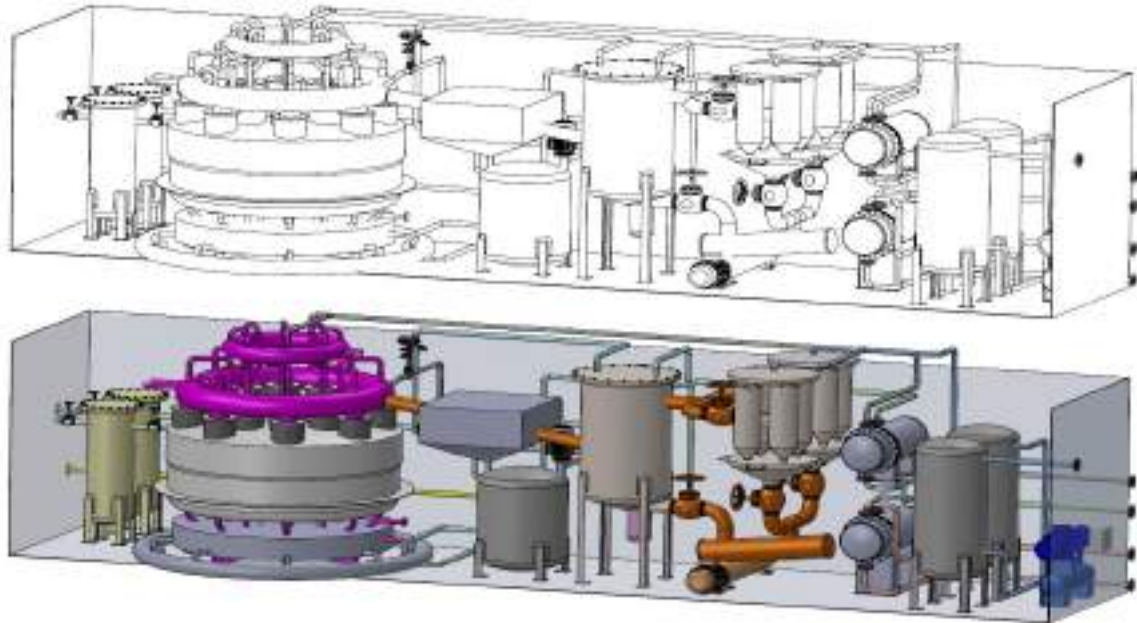

Figure 31. System Isometric Diagram

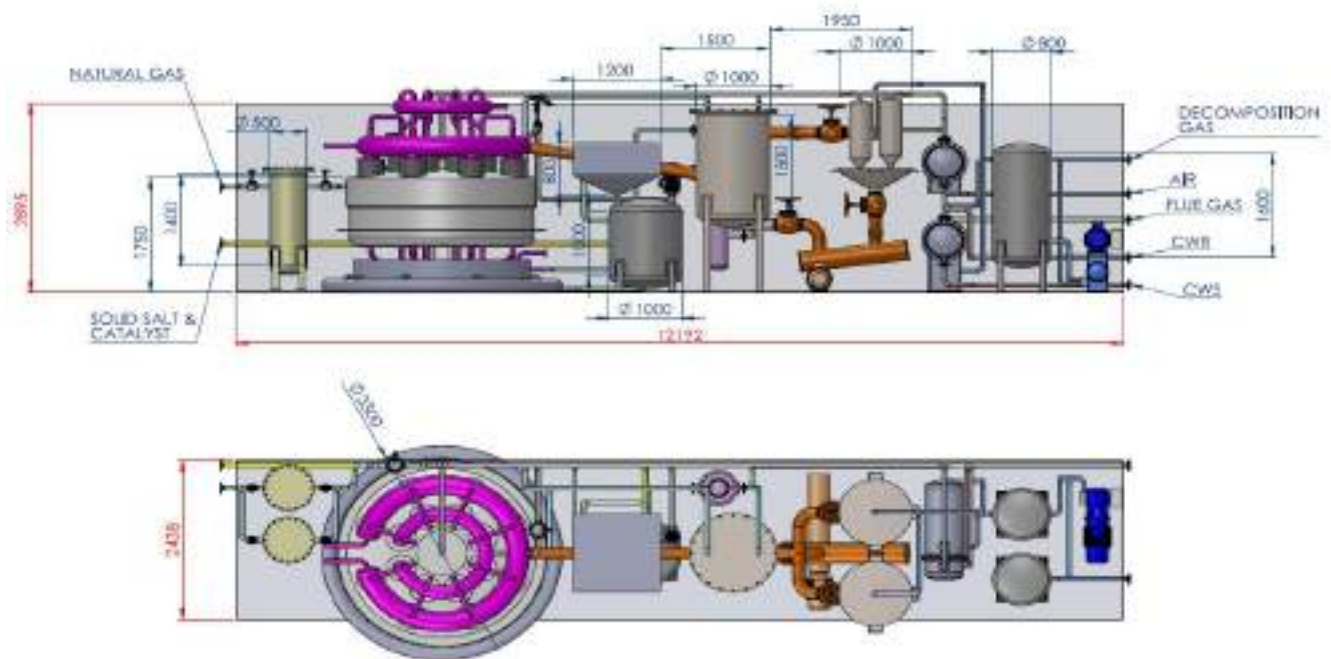

Figure 32. System General Arrangement

#### 4.6.1 Process Description

The NG-to-H<sub>2</sub> system is connected into vessels' FGSS to receive the feed gas supply and to deliver the decomposition gas that is produced (a mixture of H<sub>2</sub> and CH<sub>4</sub>) back to FGSS. The decomposition gas is mixed with vapourised natural gas in the FGSS before being delivered to the engine as fuel gas. With the engine technology currently available, it is not possible to operate the NG-to-H<sub>2</sub> system as a standalone fuel-supply system; therefore, the FGSS still takes priority and needs to be fully operational for the NG-to-H<sub>2</sub> system to be used.

The natural-gas-to-hydrogen decomposition system uses the TCD principle to decompose  $\text{CH}_4$  into  $\text{H}_2$  and  $\text{C}$ . In the first stage, the system purifies the natural gas from sulphuric components in a sweetening step. Then it is heated in a preheater before being sent to decomposition reactor.

The decomposition reactor requires heat and a molten catalyst which causes an endothermic decomposition reaction to take place and generate hydrogen gas and solid carbon. A mixture of solid carbon and decomposition gas goes through a separation process which collects solid carbon away from the particle-free decomposition gas.

The decomposition gas is then pressurised with a dedicated compressor and cooled down with a dedicated cooling arrangement to fulfil the fuel-gas condition requirements of a combustion engine. The product gas is called 'decomposition gas', which is a mixture of produced hydrogen gas and the remaining unreacted natural gas.

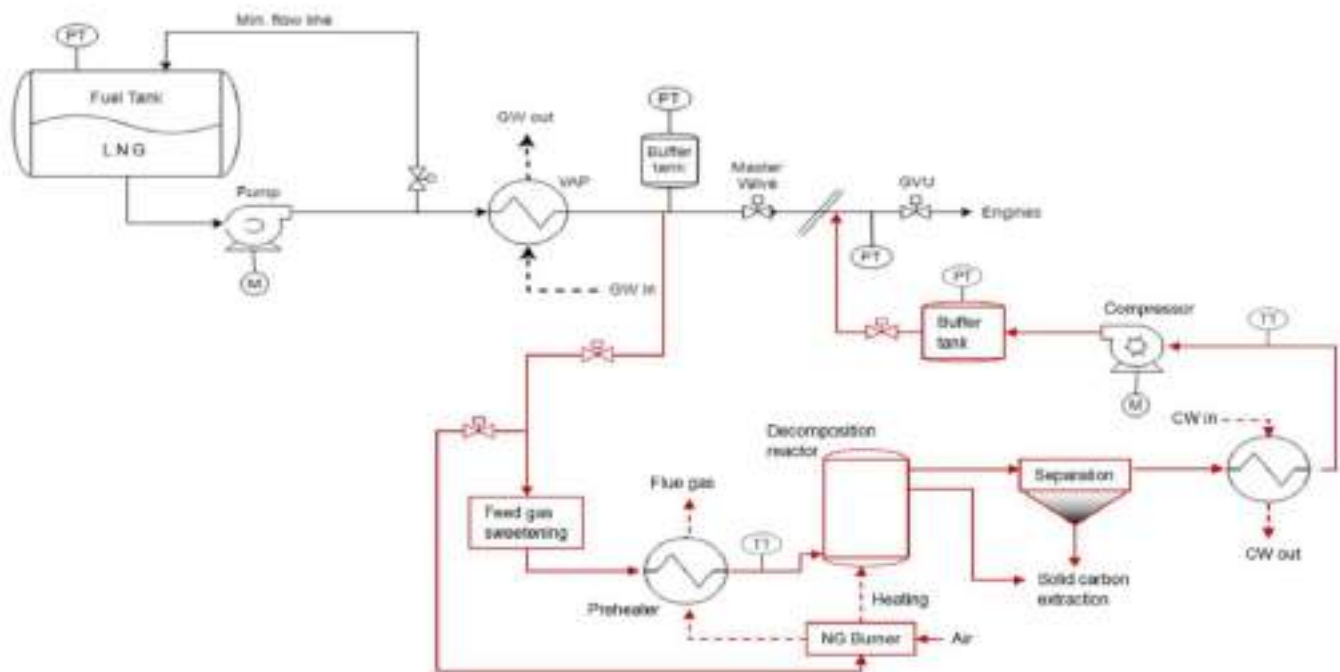

Figure 33. Simplified Process Diagram

During the workshop, the following three concept applications were considered and discussed to identify risks; Figure 34. Chemical Carrier Application, Figure 35. Passenger Ferry Application (New construction), Figure 36. VLCC Application show the GA for those three concepts.

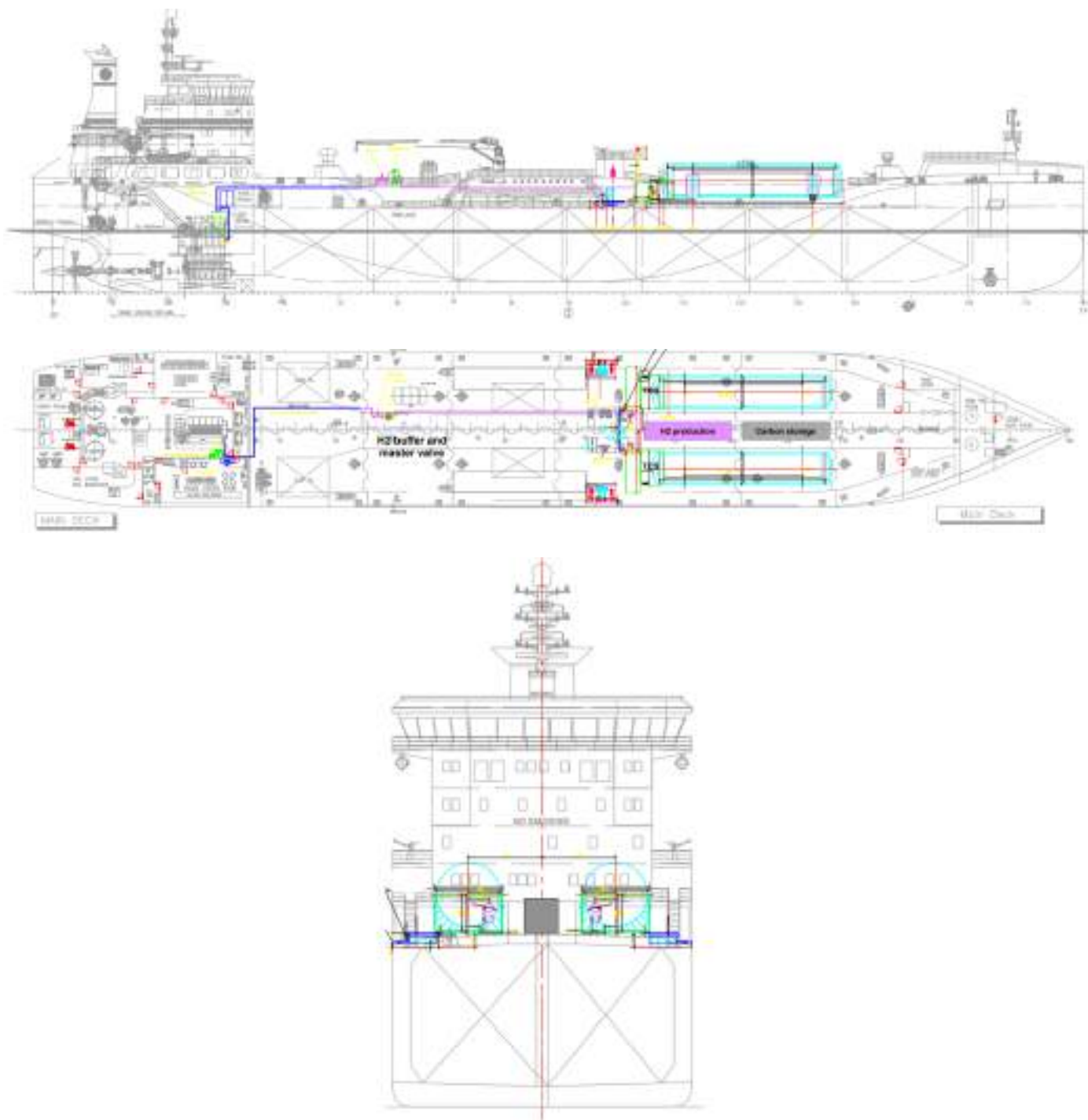

Figure 34. Chemical Carrier Application





- The capacity of relief valves will meet requirements from the IGF Code and ABS.
- All releases from the TCD system through the relief valves will release to a single-vent mast.
- During shutdown, nitrogen will purge the TCD system and fuel lines.
- Heating and cooling systems have an intermediate water/glycol circuit to avoid contamination of the ship's cooling water.
- The intermediate heating/cooling circuit will use a water/glycol medium.
- LNG specs are not a significant concern, because the TCD process will work with various LNG compositions to break down NG without engine issues.
- Incoming gas to the TCD comes from the FGSS in gaseous form.
- The TCD system is in a closed containment with limited H<sub>2</sub> gas stored inside; H<sub>2</sub> is contained only in the piping after the reactor.
- TCD container has ventilation offering 30-45 air changes per hour.
- TCD will have an explosion-relief hatch for structural protection.
- The internal temperature of the TCD container and all electrical equipment will be maintained at approximately 45°C.

#### **VLCC and Product Carrier:**

- The LNG tank and TCD is located on top of cargo tanks
- LNG is stored in a Type C tank
- Fuel gas and TCD vents are separated at an appropriate distance
- VLCC can store carbon either on deck in a container or in empty fuel tanks
- Product carrier will store carbon on deck in container or in prismatic hull tanks
- A four-stroke engine is proposed
- Alternatively, the VLCC can install TCD in front of accommodation

#### **Ferry:**

- LNG tank and TCD is installed inside hull
- Two-stroke dual-fuel engine is proposed

### **4.6.3 Results and Recommendations**

During the HAZID workshop, all high-level risk were considered and the safeguards required by codes/standards/regulation were identified. Risk rankings were developed and are listed in Appendix XIII – HAZID Register CH<sub>4</sub> to H<sub>2</sub> Technology.

Due to the wide flammability range, the very requirement for ignition energy, the comparatively small atom size, high flame velocity, high diffusivity and buoyancy, high pressure and high process temperature (above auto ignition of H<sub>2</sub>), many risks and safeguards were identified; a significant proportion of these were additional to those required by IGF Code because the proposed process has been not covered by the IGF.

For process itself, there are enough industry codes and standards available in process industry. But for marine applications, experience from the offshore industry is utilised. Considering the proximity of the hazards and risks, many recommendations will likely require further analysis and research. However, they are all listed for consideration and may help to inform prescriptive requirements and safer designs and arrangements. The recommendations developed by the team are listed in Appendix XII – List of Recommendations CH<sub>4</sub> to H<sub>2</sub> Technology.

Table 34. CH<sub>4</sub> to H<sub>2</sub> - HAZID Risk Ranking Summary

Node #	Key system level HAZID nodes	Risk Ranking of Hazards Identified			
		Low	Moderate	High	Extreme
1	TCD System - Feed gas, Gas Sweetening, Feed Gas Preheater	13	23	1	-
2	TCD System - Feed Gas Decomposition Reactor	7	17	15	-
3	TCD System - Molten Salt Separator (012V01) and Molten Salt Collection Tank (012V02)	3	8	10	-
4	TCD System - Feed Gas Final Preheater	1	3	-	-
5	TCD System - Carbon and Decomposition Gas Separation	-	-	2	-
6	TCD System - GA inside Container	-	1	-	-
7	TCD System - Venting System	-	-	-	-
8	TCD System - Ventilation system	-	2	1	-
9	TCD System - Chemicals	-	2	1	-
10	TCD System – Container-Safety System	-	-	-	-
11	TCD System - Maintenance Operations	-	2	5	-
12	Vessel - General Arrangement - Bunkering	-	-	-	-
13	Vessel - General Arrangement - Fuel Storage	-	-	-	-
14	Vessel - General Arrangement	2	8	22	-
15	Vessel – Fuel-Gas Supply System (FGSS) for Engine and TCD	-	3	-	-
16	Vessel - Fuel Tank Connection	-	-	-	-
17	Vessel - Boil-off Gas Handling/Return	-	-	-	-
18	Vessel - Engine Room Arrangement/ Fuel supply from FGSS/TCD to Engine room	-	1	-	-
19	Vessel - Engine/Consumer	-	3	1	1
20	Vessel - Ventilation and Venting System	-	3	3	-
21	Vessel - Safety Systems (F&G Detection, Active & Passive Firefighting, etc.)	2	6	9	-
22	Vessel - Ship Operation/Simultaneous Operation	-	4	-	-
23	Vessel - Emergency Escape, Evacuation and Rescue (EER)	3	4	5	-
24	Offshore installation	1	1	4	-
<b>Total</b>		<b>32</b>	<b>91</b>	<b>79</b>	<b>1</b>

The key findings and recommendations from the HAZID study and the additional risks that would need to be addressed for the CH<sub>4</sub>-to-H<sub>2</sub> process used in the various ship-type applications are summarised below:

- The TCD installation should be considered very carefully due to risks such as deflagration to detonation as this process operates at high temperatures and in enclosed spaces. Additional studies such as HAZID/HAZOP/LOPA, dispersion analysis and fire/explosion analysis must be conducted and additional measures put in place to minimise these risks at the appropriate stages.
- TCD ventilation is to be further studied for various release scenarios and discover if H<sub>2</sub> concentrations can be maintained below acceptable levels to minimise the risk of deflagration/detonation.

- Collection of the carbon produced and its storage is to be further studied at the project stage. Wetting the carbon at the last minute to a slurry with filtered seawater and then pumping it out is advised for fast operation.
- Engine manufacturers are to test engines with blend in hydrogen mixtures (e.g. up to 50% energy) and additional safety studies are required to identify additional risk and mitigation measure, if H<sub>2</sub> is found to pose any additional risks for the engine room or FGSS.

This technology is proposed for various types of ships:

- Dropped-object risks are significant when a TCD containment and CH<sub>4</sub>/H<sub>2</sub> piping are placed ondeck. No overhead lifting should be allowed above those areas. If not, an assessment of dropped-object risks will need to be performed to add reinforce safety conditions.
- Conduct an extensive reliability, availability and maintainability (RAM) study at a later engineering stage and incorporate those results in the maintenance procedures.
- A detailed study is to be developed for the project and dispersion analysis conducted to help ensure that exhaust and LNG/H<sub>2</sub>/product ventilation will not create explosion and fire hazards.
- The TCD containers should offer explosion hatches to safely handle sudden rises in pressure and minimise the damage to surrounding equipment, cargoes, etc.
- Determine the type of insulation/cladding that will allow the TCD's exhaust-vent piping to maintain surface temperatures below the auto-ignition temperature and maintain unit integrity during inclement weather.
- Collision/grounding can pose significant risks to the integrity of the LNG tank, TCD equipment and piping if installed near the bottom of an enclosed space (in the case of the Ro-Ro/Ro-Pax vessels). While the arrangement of the fuel tanks and TCD complies with the IGF Code, it needs to be re-evaluated to consider the risk to passengers and assets.
- An emergency evacuation and rescue study should be performed to consider worst-case scenarios from an H<sub>2</sub> leak, or a fire/explosion in the TCD container.
- The weather impacts (low temperatures, ice build-ups, etc.) to all equipment, piping, valves and instruments installed on an open deck need to be considered as these conditions can impair employee functionality and their ability to perform operational tasks.
- For TCD container and LNH tanks installed in enclosed spaces (Ro-Ro/Ro-Pax), further studies are to be conducted to consider the impact of smaller spaces, congestion, equipment density, etc. These conditions have potential for a great impact on safety with respect to:
  - Maintainability of equipment and systems
  - Inspection and monitoring
  - Potential for deflagration to detonation
  - Asphyxiation
  - Hull damage
  - Water ingress

## 4.7 Hydrogen HAZIDs Conclusions

The HAZID studies demonstrated that the major concerns related to hydrogen as marine fuel are related to hydrogen's flammability range, leakage, flame speed and detonation/deflagration issues. These issues require further studies to understand the risks and additional safeguards that will need to be implemented to prevent or mitigate the major hazards.

Gaseous hydrogen is a non-toxic, non-corrosive, highly flammable and explosive gas with wide flammability limits, a low minimum ignition energy, a fast-burning velocity and burns with a nearly invisible flame. It is colourless, odourless, tasteless and does not support life (asphyxiant). Liquid hydrogen is transparent with a light blue tint and it is non-corrosive. It is the smallest molecule in all available fuels.

The HAZID studies identified preventive and mitigative safeguards and recommendations for various ship types. While some safeguards stemmed from the IGF Code for methane as marine fuel, many of these safeguards are not found in the Code are considered additional due to the inherent risks of hydrogen.

It is important to note that not all safeguards and recommendations listed in HAZID registers will be applicable to all ship types. Some are obviously practical and of benefit, but others may require a further investigation of their merit. However, they are all listed for consideration and may help to inform prescriptive requirements and develop inherently safer designs and arrangements. Importantly, the additional safeguards and recommendations will contribute to further risk reduction.

It is also important to consider that hydrogen fuel is new to shipping; it is also not commonly transported as cargo.

However, hydrogen is being produced and used in petrochemical industry, automotive sector and as propellant for rocket fuel. Therefore, existing safety practices from industries such as these are valuable to adopt and further evaluate for marine applications.

The important physical and thermodynamic properties of hydrogen are discussed and listed in Section 4.1 and were used throughout risk assessments.

### *Flammability Limit*

Hydrogen has a very high flammability limit, which poses a very high risk and is combined with very low energy requirement for ignition. Ignition sources typically ignored for other hydrocarbon-based fuels and other applications have the potential to become key ignition sources in hydrogen applications. Table 31 lists known ignition sources that need to be considered for hydrogen applications. Please note that there may be additional sources, depending on the application. As ships have many systems and components (equipment) that can lead to arcs and sparks being created, the designs for areas where hydrogen can be expected during leak need to be carefully considered.

### *Flame Propagation*

Hydrogen's flame speed is much higher than other gases and can reach sonic velocity in certain circumstances. The ease of ignition associated with hydrogen/air/oxidant mixtures combined with their high flame speeds increases the potential for high-energy releases that can lead to deflagration and/or detonation, explosion and fire. The principal hazard presented by hydrogen systems is the uncontrolled combustion of accidentally released hydrogen. Due to its small molecule size, the potential is high for leaks and the formation of combustible mixtures. Any enclosed and semi-enclosed spaces are to be considered for such events and the designer need to consider this risk at highest level of all operational modes.

### *Leak Potential*

Hydrogen's low viscosity (8.81  $\mu\text{Pa}$  at NTP [normal temperature and pressure]) and its small molecular size allows it to pass through porous materials, fittings/connections, seals, joints and small cracks more readily than other fluids. The low viscosity of hydrogen, another effect of the small size of the molecule, causes a comparatively high flow rate when it leaks through porous materials, fittings or seals. This creates a very high potential for leaks compared to other fuels and needs to be addressed by proper design, selection of material and maintenance practices. Leak and fire detection is key to mitigating risk.

### *Material Selection*

Due to their small size, hydrogen atoms can permeate into the lattice structure of materials, which leads to a significant loss of material ductility. The material degradation caused by embrittlement can result in a catastrophic failure of the system and equipment carrying or storing hydrogen. Judicious material selection and a robust assessment of their compatibility to use with hydrogen in a marine environment is vital to maintaining the integrity of the system and minimising the risks of material failure.

### *Bunkering*

Because hydrogen fuel could be used by a wide variety of ships that travel to and from disparate port environments, there will be additional risks for bunkering. Bunkering is expected to take place at or near a port location that is usually close to cities and other vulnerable areas. Being able to account for the potential explosion risk from any release of hydrogen during bunkering will be a primary concern for responsible shipowners. As designs mature and the adoption of hydrogen as a fuel expands throughout the maritime industry, it is expected that additional studies will be conducted in co-operation with local governments and port authorities.

The following studies should be considered at the development stages for hydrogen-as-fuel projects.

- Procedural HAZID/HAZOP and Simultaneous Operation (SIMOPS) for bunkering operations
- Development of an emergency plan with local port authorities and regulatory bodies to consider the hydrogen hazards to local human and aqua life.
- Mooring analysis for each type and size of vessel, with its supporting bunker vessel.
- Plans for 24-hour monitor of mooring-line tension, vessel separation and weather -fuelled engines; some have entered prototype testing, but there are not fully approved/type-tested engines on the market. In the coming years, as testing progresses, it is expected that more information will be made available, allowing safety issues to be addressed. These are some of the present concerns that need to be resolved:
- The impact of NO<sub>x</sub>, SO<sub>x</sub> and N<sub>2</sub>O (particularly, N<sub>2</sub>O which is harmful to humans).
- A reassessment of engine-room safety systems from is not expected to produce any relevant emissions.

### *Fuel System*

Hydrogen fuel systems, which will feed the potential fuel to the engine or fuel cell, will be new to the marine industry. There are basically two concepts for these fuel systems: high and low pressure. Each system has its own set of risks that need to be considered. Many of these have been defined in this study, with the primary concerns and recommendations summarised below:

- Considering the higher potential for leaks with hydrogen, the number of joints, connections, seals and gaskets are to be minimised. The selection of sealing/gasket materials is to be studied for hydrogen applications.
- Engine manufacturers and shipyards/designers will need to work together to design the entire hydrogen fuel system.
- Ventilation of fuel-preparation room will need to consider the wide flammability range of hydrogen.
- Depending on the type of vessel, the location of the fuel-preparation room will present its own unique risks, which will need to be addressed with remedial actions supported by additional studies.
- Due to the different risks presented by dropped objects when cargo handling (depending on ship type), the entire handling operation will need to be independently reassessed to identify the potential threats to the fuel-preparation room, fuel piping and fuel tanks.
- Recommendations for structural fire protection will need to be followed.
- Additional studies on fire and explosion risks from external and internal factors will need to be conducted.
- Depending on the general arrangement, the fuel piping on the weather deck will need to be adequately protected against dropped objects or other physical damages; double-walled piping with protection should be considered.

### *Accommodation*

From a risk perspective, the general arrangements for accommodation should be a primary concern. Each arrangement should be studied separately when fuel storage is located close to mariner accommodations. The safest location always will be away from the accommodation, in the cargo hold or on the weather deck. Additional safety measures to be considered are:

- Placing hydrogen detectors at all air inlets for the accommodation spaces.
- Life-saving appliances should be located as far away as practicable from the hazardous zones and account for worst-case discharges.
- The side of the accommodation closest to any potential hydrogen release, fire or potential explosion area should have adequate structural protection.
- The explosion risk and potential to impact accommodation structurally needs to be evaluated and the appropriate mitigation provided.

### *Fuel Storage*

Fuel storage will need to be in compliance with the requirements of the IGF and IGC Codes. The tank designs themselves may be to Code, but hydrogen may bring additional internal/external risks that need to be evaluated and addressed. These items may require additional attention:

- Pressurised storage pressure is expected to be high (200-700 bar); that alone creates higher risks for containing fuel in the system. Systems are to be designed to minimise leaks due to failure of containment or systems component, malfunction, human error, etc.
- Data suggests most groundings and collisions happen near ports or populated areas. These events can cause damage to tanks located in the cargo holds and release hydrogen into the cargo hold space and atmosphere. The potential impact of blast/detonation/deflagration on the surroundings and people on the ship will need to be evaluated and safety responses put in place.
- A related safety plan to protect mariners from such an event will need to be put in place.
- Considering the high pressure of hydrogen storage, the associated risks will need to be further studied and considered in system designs and during equipment/valve/instrument selection.
- The ship types and location of fuel tanks will bring additional risks such as cargo fires, dropped objects, proximity to passenger areas, etc. The potential impact of these features will need to be studied and defensive strategies put in place.
- For on deck fuel-storage systems, depending on the type of vessel and cargo operation, there may be increased risks from dropped objects or other cargoes. The related risks will need to be evaluated.
- Any on-deck fuel storage tanks should be considered from the perspective of collision risk and the location of those fuel tanks will need to be further studied.

### *Ventilation*

Most hydrogen systems (fuel preparation, fuel consumer, etc.) are likely to be located in enclosed spaces, either near accommodations or in cargo blocks. The starting point for ventilation will be to comply with the IGF Code. Due to wide flammability, ventilation studies will need to be conducted, with an eye to increasing the rate of air flow during emergencies to maintain hydrogen levels as far as possible below LEL (lower explosive limits). All ventilation inlets and outlets will need to have enough separation to avoid mixing and interfering with other ventilation openings.

### *Vents*

The location and height of vents will require special consideration. The separation between openings/inlets and vents should be greater than the requirements in the IGF/IGC Codes. For safety, a gas-dispersion analysis for multiple release scenarios will be needed to establish hazardous zones. Considering deflagration, potential vent systems are to be designed to prevent air ingress into that system. During venting, a vent mast may catch fire, so venting systems should be designed to limit the consequences. As far as possible, vent mast should be of welded construction to minimise any leaks.

### *Electrical equipment and installation*

Considering hydrogen's wide flammability and very low energy requirement for ignition, all equipment is to be in compliance with hazardous area classifications. All system/equipment to be bonded to give protection against the hazards associated with electrical currents and static electricity. The potential for build-up of any electrostatic charges needs to be avoided and a specific study needs to be conducted.

### *Safety Systems*

The number of gas detectors and their location are to be determined based on a proper dispersion- and detector-mapping study. Gas-detection equipment should trigger alarms and shutdowns based on flammability limits. The selection of efficient hydrogen detectors is critical to these safety systems.

With invisible flames and low radiant heat, it is difficult to detect hydrogen fires, so a proper study to select efficient detectors and the best locations for their placement is to be conducted.

More effective fire prevention enabled by a detector system that can identify leaks (for example, gas or noise detection), either in addition to or instead of a flame-detection system. The design and location of detection systems can be optimised with a hazard analysis that takes into consideration:

- the most probable location of leaks;
- the sources of hydrogen from maloperations;
- areas where hydrogen may collect;
- the location of staffing and personnel; and
- based on past incidents.

## Emergency

An effective emergency-response study will need to be conducted and associated plans put in place with controls and adequate training.

## Personal Protective Equipment (PPE)

Suitable PPE for use with hydrogen gases will need to be provided onboard for each mariner.

Certified lifesaving appliances will need to be provided to ensure survival and escape when hydrogen is released into the atmosphere and it is advised that suitable a study be conducted.

## Firefighting Systems

For hydrogen fires (e.g., jet fires), the best mitigation is to spray water on the surrounding equipment area to protect it from heat and isolate the equipment/system to minimise the fuel/inventory which is feeding fire. Do not extinguish the fire while the flow of leaking hydrogen is continuing, because there is a danger of creating an explosion hazard.

## Summary of major hazards and causes

Table 35 below summarises the hazards and causes for each system-level node in the HAZID studies.

Table 35. Summary of hazards and causes from HAZID studies

System/Area	Hazards	Causes
<b>Bunkering</b>	Hydrogen leak	<ul style="list-style-type: none"> <li>- Material degradation</li> <li>- Connection leak</li> <li>- Joint leak</li> <li>- Operator error</li> </ul>
	Hydrogen leak – hose failure/ loading arm	<ul style="list-style-type: none"> <li>- Vessel movement</li> <li>- Mooring line failure</li> <li>- Extreme weather</li> <li>- A passing vessel generating a huge wave</li> <li>- Dropped object</li> </ul>
<b>Global Risk</b>	Vessel collision leading to hydrogen leak and fuel tank damage	<ul style="list-style-type: none"> <li>- Pilot/human error</li> <li>- Port congestion/traffic density</li> <li>- Low Visibility</li> <li>- Adverse Weather</li> </ul>
	Grounding leading to hydrogen leak and fuel tank damage	<ul style="list-style-type: none"> <li>- Pilot/human error</li> <li>- Adverse Weather</li> <li>- Low Visibility</li> <li>- Miscommunication / Lack of information</li> <li>- Port congestion/traffic density</li> </ul>
<b>Fuel Storage</b>	Hydrogen leak	<ul style="list-style-type: none"> <li>- Manufacturing related defects on fuel storage piping and equipment</li> <li>- Over-pressurisation of fuel storage tank</li> <li>- Fatigue crack in piping and equipment</li> <li>- Material degradation</li> <li>- Human error</li> <li>- Relief valve leakage/malfunction</li> <li>- Dome connection/valve leak</li> <li>- Arc/spark</li> <li>- Dropped object impacting fuel storage area</li> <li>- Grounding</li> <li>- Vessel Collision</li> </ul>
<b>Fuel preparation/handling system</b>	Hydrogen leak	<ul style="list-style-type: none"> <li>- Connection leak</li> <li>- Flange/joint leak</li> <li>- Seal failure</li> <li>- Material degradation</li> <li>- Over pressurisation</li> </ul>

System/Area	Hazards	Causes
		<ul style="list-style-type: none"> <li>- Dropped object impacting fuel preparation/handling area</li> <li>- Arc/spark</li> <li>- Improper or lack of maintenance</li> <li>- Human error</li> <li>- Trapped gas</li> </ul>
	Structure damage	<ul style="list-style-type: none"> <li>- Over-pressurisation of fuel preparation room</li> <li>- Pressure vacuum in the fuel preparation room</li> </ul>
<b>Fuel Management system</b>	Over-pressurisation of tank	<ul style="list-style-type: none"> <li>- Human error</li> <li>- Improper training and/or procedures</li> <li>- Control instrument failure</li> <li>- Heat gain – external fire, sun load,</li> <li>- Multiple tank management</li> <li>-</li> </ul>
<b>Vent System</b>	Internal Deflagration/detonation	<ul style="list-style-type: none"> <li>- Leakage from relief valve</li> <li>- Air ingress</li> </ul>
	Local Leakage	<ul style="list-style-type: none"> <li>- Joint leak</li> </ul>
	Over pressurisation of protected system	<ul style="list-style-type: none"> <li>- HP system and LP system venting in same header</li> </ul>
<b>Engine room</b>	Hydrogen leak	<ul style="list-style-type: none"> <li>- Piston cover failure</li> <li>- Connection failure</li> <li>- Seal failure</li> <li>- Crank case failure</li> <li>- Dropped object leading to double wall pipe rupture in the engine room</li> <li>- Improper or lack of maintenance</li> <li>- Improper training and/or procedures</li> <li>- Human error</li> <li>- Leakage from GVU (if located inside engine room)</li> </ul>
	Exhaust explosion	<ul style="list-style-type: none"> <li>- Unburned hydrogen in exhaust</li> </ul>
	Hydrogen gas release in secondary systems	<ul style="list-style-type: none"> <li>- Hydrogen migration into lube oil, cooling water circuit</li> </ul>
<b>Accommodation</b>	Internal fire	<ul style="list-style-type: none"> <li>- Gally fire</li> <li>- Electrical fire</li> </ul>
	External fire	<ul style="list-style-type: none"> <li>- Cargo fire</li> <li>- Hydrogen-related fire</li> </ul>
	Hydrogen migration into accommodation	<ul style="list-style-type: none"> <li>- Hydrogen tank leakage</li> <li>- Fuel handling room leakage</li> <li>- Tank damage due to vessel collision or grounding</li> <li>- Cargo fire</li> <li>- Relief valve discharge to vent mast</li> </ul>
<b>External risk</b>	Grounding	<ul style="list-style-type: none"> <li>- Human/pilot error</li> <li>- Low visibility</li> <li>- Adverse weather</li> <li>- Lack of information</li> </ul>
	Collision	<ul style="list-style-type: none"> <li>- Traffic density in area</li> <li>- Human/pilot error</li> <li>- Visibility</li> <li>- Weather</li> <li>- Miscommunication/Lack of information</li> </ul>
	Dropped object	<ul style="list-style-type: none"> <li>- Cargo mishandling</li> <li>- Simultaneous operation</li> </ul>
	Cargo fire	<ul style="list-style-type: none"> <li>- Cargo container with petroleum product and other transported cargo</li> </ul>



## 5. Overall Conclusions of Hydrogen Study

From the perspective of life-cycle GHG emissions, green hydrogen currently is seen as one of the fuels that could contribute to shipping's decarbonisation. Industry-wide experience has not revealed any serious obstacles. However, equipment and fuel costs, in combination with the need to develop and scale up the distribution and port infrastructure, are the main barriers to its use as a primary fuel for global shipping. At the same time, there is an obvious need to build the production capacity for **green** hydrogen, which has the greatest decarbonisation potential among hydrogen options. Ultimately, hydrogen may prove to be more appropriate for short-sea than deep-sea shipping due to the fuel's low energy density and the commercial trade-offs inherent in building onboard storage capacity.

The current global production of hydrogen is about 94 million tonnes a year, mainly produced from steam-methane reforming or autothermal reforming using natural gas or coal as a feedstock (grey hydrogen). Despite the comparatively low tank-to-wake emissions, the well-to-tank GHG emissions of grey hydrogen are significant, because the current production processes rely mainly on natural gas and coal. In fact, the well-to-tank emissions of grey hydrogen could be higher than of conventional marine fuels, depending on the amount of methane leakage across the supply chain.

The global production of hydrogen from renewable energy is expected to increase due to stricter emissions regulations. With almost no well-to-tank emissions, the use of green hydrogen could offer as much as a 97% reduction in GHG emissions compared to grey hydrogen and up to 96% compared to MGO (marine gas oil) and HFO (heavy fuel oil). Its potential to mitigate the release of a range of air pollutants makes green hydrogen an interesting solution for shipping.

The production pathways for green hydrogen are electrolysis (using renewable electricity), thermochemical biomass conversion, direct solar hydrogen production and biomass fermentation. The first two pathways appear to be the most promising technologies in the short term. However, due to the limited amounts of sustainable biomass, production by means of water electrolysis is more promising in terms of potential production capacity. This methodology, however, would require a significant increase in the production of renewable electricity. To be noted that the global electrolyser capacity dedicated to producing green hydrogen is currently only about 0.3 GW, while the announced global capacity reached 260 GW in 2021.

Clearly, the global production capacity of renewable electricity will need to undergo tremendous growth, even just to fulfil only the potential demand for 'green' energy from the maritime industry. While the projected availability of renewable electricity in 2040 appears to be sufficient to cover the demand for green hydrogen for shipping. The projections for electrolyser capacity in 2040 are not that promising. Also, it is important to remember that the shipping industry will be competing with many industrial sectors for the volumes of green hydrogen that are produced.

It should also be noted that this production pathway requires pure and deionised water, which could contribute to water-scarcity trends as its production increases. Desalinated water is an alternative possibility. The manufacture and installation of the wind parks, solar parks, electrolysers and fuel cells that will be required to produce greener hydrogen may also come with some negative environmental impacts, such as damage to the habitats of birds and bats during the construction and operation of wind farms. Shifts in land use due to the increased need for renewable electricity should be closely monitored and preference must be given to non-agricultural lands and/or offshore wind production. Overall, the viability of most alternative renewable-fuel pathways is still being investigated and further research is needed before major changes are undertaken to boost the production capacities.

Regarding air emissions other than GHG, hydrogen leaks also contribute to global warming because it is an indirect greenhouse gas. However, two studies have shown that the inherent reduction in GHG emissions (from less fossil fuel use) from a switch to a green hydrogen economy would have a net positive impact on the climate, even if hydrogen losses into the air during the production/combustion processes reached as high as 10% of the volume burned. The combustion of hydrogen can also produce NO<sub>x</sub>, but, with adequate control of the combustion conditions and SCR (selective catalytic reduction) aftertreatment, the NO<sub>x</sub> emissions are probably lower than for HFO engines. Other emissions and air pollutants such as sulphur dioxide, carbon monoxide, heavy metals, hydrocarbons, PAHs and PM are significantly reduced with hydrogen compared to traditional fuels. The use of pilot fuels may induce some emissions and air pollution, but these can be mitigated.

Concerning the readiness of the technologies to burn hydrogen, the associated fuel cells and engines are already available, but only smaller 4 stroke-engines. For the time being there are no firm plans for development of the bigger 2-stroke engines for the use of hydrogen. Engines with the Otto cycle will probably dominate early adoption, since the cost for the FGSS (fuel gas supply systems) can be cheaper than the diesel-cycle alternative. However, it should be noted that hydrogen fuel systems are expensive. Current pressurised tank technologies are suitable for storing hydrogen in gas form, however, their volume efficiency is low and the tank system is costly. This makes the business case for short-sea shipping better than for long haul routes, since vessels with more frequent port calls and bunkering activities could overcome this issue. Apart from the cost (including the fuel cost itself, which is higher than conventional fuel), this study did not reveal any other significant barriers for hydrogen to be used as fuel, provided there is an adequate fuel supply. Liquid hydrogen storage is technically another option. However, this would require a significant amount of reliquefaction due to the high volume of BOG (boil-off gas). This would negatively impact on the operating expenses (OPEX) for ships and systems that already feature comparatively high CAPEX.

To transport hydrogen on longer routes, material-based storage, such as liquid organic hydrogen carriers (LOHC) and ammonia-as-hydrogen carriers appear to be less costly solutions than physical storage. Also, sorbents and metal hybrids should be further investigated.

Using LOHCs for merchant shipping has further to be investigated. It will have a big impact on the ship design, as besides the LOHC tanks has to be implemented, and the hydrogen will need to be released onboard using a dehydrogenation catalyst. This equipment will need to be developed for marine use. This type of solution could initiate a decision to develop large-bore engines for the use of hydrogen as a marine fuel.

The development of precombustion carbon-capture solutions such as thermo-catalytic decomposition would rely on having hydrogen engines and fuel cells available, and the advantage is that they do not require hydrogen storage since hydrogen-carriers other than hydrogen are stored onboard ships. Since this technology produces solid carbon from the decomposer instead of liquid CO<sub>2</sub> and given the huge demand for graphite and solid carbon in today's market, this can be turned into potential income. So, this type of technology may also pave the way for the development of 2-stroke, large-bore hydrogen engines.

In terms of TCO (total cost of ownership), the cost gap between 'blue' hydrogen-powered and conventional fossil-fuelled vessels may almost close by 2050, if hydrogen-production costs fall, the CAPEX for hydrogen systems declines, while the cost for fossil fuels escalates along with the carbon pricing. Considering carbon pricing, the example cases of ferry Ro-Pax and Ro-Ro vessels presents a TCO for green hydrogen that is about 3 times higher than vessels powered by conventional (fossil) fuels in 2030, and about 20-30% higher TCO in 2050. If no carbon costs accrue, the TCO for the green hydrogen-powered vessels analysed might, however, in a high price scenario, remain up to four times higher than the TCO of the conventional vessels. Overall, it seems that there are other alternative fuels associated with lower additional TCO to support the transition to zero-carbon shipping.

To be noted that in this study, the distribution cost for ammonia (including an efficiency loss in the reforming of NH<sub>3</sub> to H<sub>2</sub>) has been considered in the TCO, since this was found to be the cheaper than distribution of hydrogen. This means that the demand for green hydrogen is fulfilled by importing green ammonia, which is subsequently converted to liquid hydrogen at the bunkering ports. In case it turns out that hydrogen in general is turned into ammonia to lower transportation cost and marine engines/fuel cell using ammonia have the same fuel efficiency as the hydrogen ones, then it is unlikely that ammonia will be reformed back to hydrogen as this will result in an additional cost due to the reforming.

While there is practical experience from other industries with the use, generation and handling of hydrogen, there are limited regulations for its use as a marine fuel. This may be a barrier to its adoption, but there are established methods for approving ship designs, such as using the risk-based 'alternative design' approval process. To facilitate the adoption of hydrogen, for example, classification societies have already started working on developing guidelines and setting requirements. Concurrently, GHG regulations are being put in place in the EU through initiatives such as the 'Fit-for-55' package of measures; these should provide a regional framework to incentivise the transition to low- and zero-carbon fuels. At the IMO, discussions are underway on Marine Fuel Life Cycle GHG Analysis and Market-Based Measures; in principle, this too should provide stimulus for fuels such as hydrogen.

Regarding safety, this analysis demonstrated that the major concerns related to hydrogen as marine fuel are related to its flammability range, leakage potential, flame speed, and detonation/deflagration issues. These issues require further studies to understand the risks and additional safeguards that will need to be implemented to prevent or mitigate the major hazards. The HAZID studies identified preventive and mitigative safeguards and recommendations for various ship types, including the development of emergency plans, training requirements and collaborative efforts

to design the entire hydrogen fuel system. While some safeguards stemmed from the IGF Code for methane as marine fuel, many identified in the studies are considered additional safeguards, due to the inherent risks of hydrogen. It is important to note that not all safeguards and recommendations listed in the HAZID registers will be applicable to all ship types. However, they are all listed for consideration and may help to inform prescriptive requirements and develop inherently safer designs and arrangements. Importantly, the additional safeguards and recommendations will contribute to further risk reduction.

To conclude, for the shipping industry, hydrogen is a new fuel, which is also not commonly transported as cargo. However, it can be seen as a fuel with decarbonisation potential and since it has been produced and used in other industries, such as petrochemicals and automotive manufacturing, a first step would be to evaluate and possibly adopt some existing practices for marine application. The major challenges at the moment, apart from the availability of green hydrogen, is the cost for developing the hydrogen fuelling infrastructure for ships, as well as the tank system to store hydrogen onboard.

Table 36. Summary of the Observations

Subject	Observation/Mitigations/Suggestions
Production	<p><b>Observation</b></p> <ul style="list-style-type: none"> <li>• Production of hydrogen is currently at 94 million tonnes worldwide.</li> <li>• This production is currently based on steam methane reforming (SMR) or autothermal reforming (ATR) using natural gas or coal as a feedstock.</li> <li>• The main pathway for production of green hydrogen consists of renewable electricity production in combination with water electrolysis.</li> <li>• Although global electrolyser capacity dedicated to producing green hydrogen is currently only about 0.3 GW, the announced global capacity reached 260 GW in October 2021.</li> <li>• Three electrolyser technologies are alkaline, PEM and SOEC. Alkaline has been in use since the 1920s.</li> <li>• Alternative pathways are available and under development that could help to increase production capacity. However, at this stage, the technological gap between the established processes and the new ones is wide.</li> </ul> <p><b>Mitigations and Suggestions:</b></p> <ul style="list-style-type: none"> <li>• In the short term, it is more feasible to rely on the currently known technologies and processes and replace the currently used ‘grey’ hydrogen with green hydrogen produced with renewable electricity.</li> <li>• Further R&amp;D should still focus on alternative production pathways to further increase production capacity.</li> </ul>
Sustainability	<p><b>Observation</b></p> <ul style="list-style-type: none"> <li>• Current production processes for hydrogen mainly rely on natural gas and coal, resulting in high well-to-tank GHG emissions. Despite very low tank-to-wake emissions, overall well-to-wake GHG emissions of grey hydrogen may be higher than conventional marine fuels, depending on the volume of methane leakage across the supply chain.</li> <li>• Green hydrogen would allow a reduction of GHG emissions of up to 97% compared to grey hydrogen, and of up to 96% compared to MGO and HFO.</li> <li>• Hydrogen leakage contributes to global warming because hydrogen is an indirect greenhouse gas. However, two studies indicate that reduced GHG emissions from reduced fossil fuel use caused by the switch to a hydrogen economy have a much larger effect and will lead to a net positive climate impact, even when the hydrogen losses are as high as 10%.</li> <li>• In the combustion of hydrogen, NO<sub>x</sub> can be formed. But, with good control of the combustion conditions and SCR aftertreatment, the NO<sub>x</sub> emissions are not significant and probably lower than for HFO engines.</li> <li>• Other emissions and air pollutants such as sulphur dioxide, carbon monoxide, heavy metals, hydrocarbons, PAHs and PM are significantly reduced compared to traditional fuels.</li> <li>• The use of pilot fuel may induce some emissions and air pollution, but these can be mitigated.</li> <li>• The production of green hydrogen requires pure and deionised water, and this can increase water scarcity as the production of green hydrogen increases. Desalination of water is an alternative possibility.</li> <li>• The manufacturing and installation of wind parks, solar parks, electrolysers and fuel cells comes with some negative environmental impacts, such as affected habitats of birds and bats during the construction and operation of wind farms.</li> <li>• Land usage due to the increased need for renewable electricity is to be closely monitored and preference must be given to non-agricultural land or offshore wind production.</li> </ul> <p><b>Mitigation and suggestions</b></p> <ul style="list-style-type: none"> <li>• The engine development at a larger scale and for bigger engines is expected to take place in this decade, shedding some light on the sustainability issues raised in the report.</li> </ul>

Subject	Observation/Mitigations/Suggestions
Availability	<ul style="list-style-type: none"> <li>• Particular attention is to be given to the availability of water to produce green hydrogen.</li> </ul> <p><b>Observation</b></p> <ul style="list-style-type: none"> <li>• The current level of production of green hydrogen is at a very low level; most hydrogen is grey and is produced as a feedstock for industries.</li> <li>• The availability of green hydrogen will depend on renewable-electricity production volumes and its availability for water electrolysis.</li> <li>• The production capacity of renewable electricity will need to undergo tremendous growth to fulfil the potential demand for green energy from maritime shipping, which will compete with many other sectors for green hydrogen.</li> <li>• There is a limit to which economies can increase the renewable-electricity and green-hydrogen production capacity, especially in the short and medium terms. The anticipated availability of renewable electricity in 2040 appears to be sufficient to cover the demand for green hydrogen. However, the anticipated worldwide electrolyser capacity in 2040 does not appear sufficient. Other industries may also compete to get the green hydrogen.</li> <li>• Any expansion of production capacity will need to take place in regions where there is high availability of wind and solar energy and favourable conditions (i.e., low production costs).</li> </ul> <p><b>Mitigations and Suggestions:</b></p> <ul style="list-style-type: none"> <li>• To fulfil the need for cheap green hydrogen, the electrolyzers will need to be operated with high load factors.                             <ul style="list-style-type: none"> <li>○ Storage facilities for hydrogen must be present when distribution cannot be ensured.</li> <li>○ The production capacity of the wind or solar park could be sized above the capacity of the hydrogen production, ensuring a higher load factor for the electrolyzers. Excess renewable electricity not used by electrolyzers can be stored or distributed to the electricity grid.</li> <li>○ An electricity connection can ensure a constant supply of electricity for the electrolyser, although not necessarily 100% green before 2050.</li> </ul> </li> </ul>
Suitability	<p><b>Observation</b></p> <ul style="list-style-type: none"> <li>• Due to its low energy density, hydrogen is widely regarded as a fuel of the future on short-sea shipping,</li> <li>• Fuel cells and small hydrogen engines are currently available and apart from the cost of the system there are no other major showstoppers identified for their use.</li> <li>• Current pressurised tank technologies are suitable for the storage of gaseous hydrogen; unfortunately, the volume efficiency is poor, and the tank system is costly, making them unsuitable for deep-sea shipping.</li> <li>• Liquid hydrogen tanks are another option for storing liquid hydrogen, although the BOG rate is high and they require significant amounts of reliquefaction. Besides the already high CAPEX for the tank system, the OPEX also can be expected to be comparatively high.</li> <li>• Material-based storage, such as liquid organic hydrogen carriers (LOHC) and ammonia-as-hydrogen carriers appear to be less costly solutions than physical storage, however further research is needed.</li> <li>• Hydrogen is an excellent fuel; it has a high heat release and develops no CO<sub>2</sub> and a low level of PM emissions. NO<sub>x</sub> emissions are not low, but they can be controlled by applying emissions abatement systems.</li> <li>• Otto cycle engines will most likely dominate in the development of hydrogen-fuelled engines. For Otto cycle engines the cost for FGSS can be cheaper than engines using diesel-cycle principles.</li> <li>• Fuel cell technology seems to be a promising alternative to internal combustion engines; development of fuel reformers/decomposers, such as TCD technology, is underway.</li> <li>• Some safety challenges arise from hydrogen handling.</li> <li>• The study did not show any insurmountable barriers to the suitability of hydrogen as a fuel.</li> </ul> <p><b>Mitigations and Suggestions:</b></p> <ul style="list-style-type: none"> <li>• Cost for storage of hydrogen is high, so further development is needed to bring down the storage cost as well as cost for dealing with high boil off gas rates.</li> <li>• Hydrogen is an indirect GHG, so more observation is needed in order to estimate the quantities of hydrogen released from piping, tanks and from combustion of engine onboard ships.</li> </ul>
Techno-economical	<p><b>Observation</b></p> <ul style="list-style-type: none"> <li>• In this study, different ship types have been evaluated.</li> <li>• In terms of TCO (total cost of ownership), the cost gap between ‘blue’ hydrogen-powered and conventional fossil-fuelled vessels may almost close by 2050, if hydrogen-production costs fall, the CAPEX for hydrogen systems declines, while the cost for fossil fuels escalates along with the carbon pricing for vessels.</li> <li>• Considering carbon pricing, the example cases of ferry Ro-Pax and Ro-Ro vessels present a TCO for green hydrogen that is about 3 times higher than vessels powered by conventional (fossil) fuels in 2030, and about 20-30% higher TCO in 2050.</li> <li>• If no carbon costs accrue, the TCO for the green hydrogen-powered vessels analysed might, however, in a high price scenario, remain up to four times higher than the TCO of the conventional vessels.</li> </ul>

Subject	Observation/Mitigations/Suggestions
	<ul style="list-style-type: none"> <li>Overall, it seems that there are other alternative fuels associated with lower additional TCO to support the transition to zero-carbon shipping.</li> </ul> <p><b>Mitigations and Suggestions:</b></p> <ul style="list-style-type: none"> <li>There is a need for international or regional policy to bridge the gap between blue or green hydrogen and conventional fuels.</li> <li>The market (including incentives and market-based measures) can also play a role in the replacement or creation of complementing policies, e.g., by increasing demand for low- or zero-carbon freight.</li> </ul>
<p><b>Rules and Regulation</b></p>	<p><b>Observation</b></p> <ul style="list-style-type: none"> <li>There are regulations currently in place covering the handling of hydrogen for in-land transportation such as cars, buses and forklifts and industrial use in steel and chemical manufacturing.</li> <li>Established methods are in place for approving ship designs using hydrogen as fuel; these are based on risk-based 'alternative-design' principles.</li> <li>The IMO Marine Safety Committee (MSC) Sub-Committee on Carriage of Cargoes and Containers (CCC) is developing interim guidelines for ships using hydrogen as fuel, with the latest draft published 22 September 2022 CCC 8/WP.3 Annex 2. Along with the IMO alternative design scheme, when these guidelines are published and adopted as an MSC circular, they will provide unified guidance for use of hydrogen as marine fuel, accompanying the MSC.1/Circ.1621, the <i>Interim Guidelines for the Safety of Ships Using Methyl/Ethyl Alcohol as Fuel</i>.</li> <li>Currently, GHG regulations are being put in place in Europe via the 'Fit-for-55' initiative and these should provide a regional framework that will incentivise the adoption of these fuels.</li> <li>In existing IMO instruments, such as the EEDI/EEXI and CII, there are no provisions to account for hydrogen. The same can be said for the NOx Technical Code in that there are no provisions for NOx or N<sub>2</sub>O emissions resulting from the hydrogen-combustion process.</li> <li>The IMO Correspondence Group has delivered the final report on Marine Fuel Life Cycle GHG Analysis to allow for a complete assessment of the GHG impacts of alternative fuels, including green hydrogen, adopted by MEPC 80.</li> <li>The IMO has already started the discussions on mid-term measures, including technical and economic element on the basis of well-to-wake emissions, and this should incentivise the use of alternative fuels.</li> </ul> <p><b>Mitigations and Suggestions:</b></p> <ul style="list-style-type: none"> <li>Support the development under the IMO CCC sub-committee of interim guidelines for hydrogen as a marine fuel.</li> <li>Encourage member states to develop national training and certification programmes under the STCW Convention and Code.</li> <li>Develop guidance to help operators implement their obligations to the ISM Code.</li> <li>Prepare the amendments to Annex VI and the NOx Technical Code that would enable approval and certification to the EEDI, EEXI and NOx regulations, together with developing amendments to Regulations 14 and 18 of Annex VI</li> <li>Request the IMO to task the ISO with developing a marine-fuel standard and relevant standards for couplings and bunkering gaseous and liquefied hydrogen.</li> <li>Encourage IACS to develop Unified Requirements for machinery and equipment and recommendations for risk-assessment guidance and hydrogen bunkering under the IGF Code to reduce industry uncertainty and support the harmonised application of requirements for hydrogen as fuel.</li> <li>Encourage SGMF, IBIA and other industry stakeholders to develop their respective guidance and best-practice publications to support the application of gaseous and liquefied hydrogen as fuel.</li> <li>National or regional environmental regulations should be standardised at an international level to prevent distribution inequalities, price unevenness and the incentivisation of the migration of green-energy production to locations that lack national and or regional regulations.</li> <li>IMO LCA guidelines should be kept under continuous review to take into account new technologies.</li> </ul>
<p><b>Risk &amp; Safety</b></p>	<p><b>Observation</b></p> <ul style="list-style-type: none"> <li>The major safety concerns related to hydrogen as a marine fuel are due to its wide flammability range, low ignition energy, potential for leakage due to small atom size, high flame speed, potential for detonation/deflagration and material embrittlement/degradation.</li> <li>Any potential for arcing/sparking needs to be avoided/eliminated due to wider flammability and low ignition energy required.</li> <li>Prevention of hydrogen gas release and dispersion is an important safety precaution.</li> <li>Material selection (metallic, non-metallic, sealing etc.) require special attention as they can lead to potential release of hydrogen.</li> <li>Enclosed areas with hydrogen will be of primary concern, in particular in fuel processing room, engine room, tank connection space, as any release can lead to detonation/fire/explosion etc.</li> <li>Ingress of air in vent masts or vent lines may lead to potential detonation inside vent lines.</li> </ul>

Subject	Observation/Mitigations/Suggestions
	<ul style="list-style-type: none"> <li>• From a risk perspective, the proximity of accommodation with respect to potential hydrogen release is a primary concern.</li> <li>• Hydrogen flames are invisible and very hard to detect.</li> <li>• Leak potential due to high storage pressure can be significant and requires special attention.</li> <li>• Purging requirements for hydrogen service requires special attention and purging gas purity should be high.</li> </ul> <p><b>Mitigations and Suggestions:</b></p> <ul style="list-style-type: none"> <li>• Training requirements will need to be in place for mariners for safe operation.</li> <li>• Specific regulations will need to be developed for the use of hydrogen as fuel in the shipping industry.</li> <li>• Research is required regarding gas and fire detection equipment capability and appropriate gas detectors are to be selected for marine environment.</li> <li>• Due to high diffusivity of hydrogen, a special dispersion study needs to be conducted and gas detector mapping study are to be performed to verify proper coverage of detection equipment to detect any hydrogen leak.</li> <li>• For each project special study and inspection needs to be done to verify elimination of any potential source of arc/spark, static charge etc.</li> <li>• Material selection procedures and proper qualification plans for each material which may come into contact with hydrogen are to be developed.</li> <li>• Design is to consider proper provision for venting and purging of each system which contains hydrogen.</li> <li>• System design to consider provision for leak/tightness test. These are to be performed after maintenance, connection/disconnection or any other activity requiring opening of system, equipment etc.</li> <li>• Systems are to be designed to eliminate any potential for air/oxygen migration.</li> <li>• Proper system design is required for high pressure hydrogen systems to minimise leak of hydrogen. It is suggested to perform detailed HAZOP, FMECA study for hydrogen system.</li> <li>• Due to high pressure of fuel storage, additional safety measures are to be introduced to prevent the uncontrolled release of H<sub>2</sub> from storage tanks.</li> <li>• All piping and equipment should be designed following the 'leak-before-break' concept to minimise the potential for failure.</li> <li>• A minimum hourly air-change rate needs to be established for ventilation of any space containing hydrogen based on arrangement and leak rates.</li> <li>• As the adoption of hydrogen as a fuel in maritime industry expands, it is expected that further research will be conducted in co-operation with local governments and port authorities to develop safe operation procedures, in particularly for bunkering operations in port and coastal areas.</li> <li>• Engine manufacturers and shipyards/designers will need to collaborate to design the entire hydrogen fuel system.</li> <li>• Depending on the type of vessel, the location of the fuel-treatment room will present its own unique risks; those will need to be addressed with actions supported further research.</li> <li>• Ventilation from the fuel-preparation room will need to be independently assessed for each project and type of vessel to address any potential for explosion/detonation/deflagration.</li> <li>• Due to the risks that dropped objects from cargo handling pose for each ship type, the entire handling operation will need to be independently reassessed to identify the potential threats to the fuel-preparation room and fuel tanks.</li> <li>• Additional analysis of fire and explosion risks from external and internal factors will need to be conducted.</li> <li>• Depending on the general arrangement, the fuel piping on the weather deck will need to be adequately protected against dropped objects or other physical damage; double-walled piping with protection should be considered.</li> <li>• An effective emergency assessment will need to be conducted and associated plans to be put in place with controls and adequate training.</li> <li>• Develop an emergency plan in consultation with the local authorities.</li> <li>• Vents systems/lines are to be properly designed to prevent air ingress, and internal deflagration/detonation; or if this is not possible, they will need to be designed to withstand internal deflagration/detonation pressure surges.</li> </ul>

## References

- ABC. (2022). *Hydrogen engine cost*. Gent, Belgium: ABC .
- ABS. (2021, June). *Sustainability Whitepaper, Hydrogen as Marine Fuel*.
- ABS. (n.d.). *SETTING THE COURSE TO LOW CARBON SHIPPING*.
- AccessScience. (2019, August). *Hydrogen fuel cell-powered marine vessels*. Retrieved October 2022, from <https://www.accessscience.com/content/briefing/aBR0801191?implicit-login=true>
- ACWA Power. (2022). *Neom Green Hydrogen Project*. Retrieved from <https://acwapower.com/en/projects/neom-green-hydrogen-project/>
- Alles Over Waterstof. (2022). *Tata Steel ontwikkelt waterstofschip*. Retrieved from <https://allesoverwaterstof.nl/tata-steel-ontwikkelt-waterstofschip/>
- AquaVentus. (2022). *AquaVentus*. Retrieved from <https://aquaventus.org/en/>
- Armstrong, A., Ostle, N., & Whitaker, J. (2016). Solar park microclimate and vegetation management effects on grassland carbon cycling. *Environmental Research Letters*, 11(7), p. 074016.
- Ash, N., & Scarbrough, T. (2019). *Sailing on solar: Could green ammonia decarbonise international shipping?* London (UK): Environmental Defense Fund.
- Atilhan, S., Park, S., El-Halwagi, M., Atilhan, M., Moore, M., & Nielsen, R. (2021). Green hydrogen as an alternative fuel for the shipping industry. *Current Opinion in Chemical Engineering*, 31, 100668.
- Aurora. (2021). Hydrogen Market Attractiveness Report (HyMAR) - Summary slides for non-subscribers.
- Australian Transport Safety Bureau. (2022). Retrieved from [https://www.atsb.gov.au/publications/investigation\\_reports/2022/mair/mo-2022-001#sourcesandsubmissions6](https://www.atsb.gov.au/publications/investigation_reports/2022/mair/mo-2022-001#sourcesandsubmissions6)
- Austria Energy. (2021). *Green Hydrogen*. Retrieved 2022, from <https://www.austriaenergy.com/en/green-hydrogen/>
- Austrom Hydrogen. (n.d.). *Pacific Solar Hydrogen*. Retrieved from <https://ah2.com.au/>
- Balkan Green Energy News. (2022). *China building world's biggest green hydrogen factory*. Retrieved from <https://balkangreenenergynews.com/chinas-sinopec-building-worlds-biggest-green-hydrogen-factory/>
- Barahmand, Z., & Eikeland, M. (2022). A scoping review on environmental, economic, and social impacts of the gasification processes. *Environments* 9(7), 92.
- Bellini, E. (2021, September 7). *Direct solar hydrogen generation tech powered by 24.3%-efficient tandem perovskite-silicon solar cell*. Retrieved from <https://www.pv-magazine.com/2021/09/07/direct-solar-hydrogen-generation-tech-powered-by-24-3-efficient-tandem-perovskite-silicon-solar-cell/>
- Blake, C., Buttner, W., & Rivkin, C. (2010). *Vehicle Codes and Standards: Overview and Gap Analysis*. Golden, CO: National Renewable Energy Laboratory. Retrieved from <https://www.nrel.gov/docs/fy10osti/47336.pdf>
- Brown, A., & Grünberg, N. (2022). *China's Nascent Green Hydrogen Sector: How policy, research and business are forging a new industry*. Retrieved from [https://merics.org/sites/default/files/2022-06/MERICS\\_China\\_Monitor\\_No\\_77\\_Green-Hydrogen\\_EN\\_final.pdf](https://merics.org/sites/default/files/2022-06/MERICS_China_Monitor_No_77_Green-Hydrogen_EN_final.pdf)
- Camacho, C., Estévez, S., Conde, J., Feijoo, G., & Moreira, M. (2022). Dark fermentation as an environmentally sustainable WIN-WIN solution for bioenergy production. *Journal of Cleaner Production* 374, 34026.
- CE Delft & Ecorys. (2021). *Assessment of impacts from accelerating the uptake of sustainable alternative fuels in maritime transport*. Brussels: European Commission.
- CE Delft & RH DHV. (2020). *Bio-Scope. Use and availability of sustainable biomass*. Retrieved from [https://cedelft.eu/wp-content/uploads/sites/2/2021/03/CE\\_Delft\\_190186\\_Bio-Scope\\_Def.pdf](https://cedelft.eu/wp-content/uploads/sites/2/2021/03/CE_Delft_190186_Bio-Scope_Def.pdf)
- CE Delft. (2021). Impacts of FuelEU Maritime on the Dutch maritime sector. Delft: CE Delft.
- Cerulogy. (2017). *What role is there for electrofuel technologies in european transport's low carbon future*. T&E.

- Cetinkaya, E., Dincer, I., & Naterer, G. (2012). Life cycle assessment of various hydrogen production methods. *International journal of hydrogen energy*, 37(3), 2071-2080.
- CF Industries. (2022). *CF Industries' commitment to a clean energy economy*. Retrieved from <https://www.cfindustries.com/globalassets/cf-industries/media/documents/cf-commitment-to-a-clean-energy-economy.pdf>
- Chowdhury, N., Shakib, M., Xu, F., Salehin, S., Islam, M., & Bhuiyan, A. (2022). Adverse environmental impacts of wind farm installations and alternative research pathways to their mitigation. *Cleaner Engineering and Technology*, p. 100415.
- CIMAC. (2021). *H2 in Stationary 4-Stroke Gas Engines for Power Generation*. International Council on Combustion Engines. Retrieved from [https://www.cimac.com/cms/upload/Publication\\_Press/WG\\_Publications/CIMAC\\_WG17\\_Gas-Engines\\_Guideline\\_H2\\_in\\_stationary\\_gas\\_engines\\_for\\_power\\_generation\\_Oct-2021.pdf](https://www.cimac.com/cms/upload/Publication_Press/WG_Publications/CIMAC_WG17_Gas-Engines_Guideline_H2_in_stationary_gas_engines_for_power_generation_Oct-2021.pdf)
- CIMAC. (2022). *WG7 Fuels*. Retrieved April 2022, from <https://www.cimac.com/working-groups/wg7-fuels/index.html>
- Colella, W., Jacobson, M., & Golden, D. (2005). Switching to a US hydrogen fuel cell vehicle fleet: The resultant change in emissions, energy use, and greenhouse gases. *Journal of Power Sources*, pp. 150-181.
- Collins, L. (2020, December). *Global green-hydrogen pipeline exceeds 250GW — here's the 27 largest gigawatt-scale projects*. Retrieved from Recharge News: <https://www.rechargenews.com/energy-transition/global-green-hydrogen-pipeline-exceeds-250gw-heres-the-27-largest-gigawatt-scale-projects/2-1-933755>
- Collins, L. (2021, September). *New 10GW green hydrogen project in Mauritania could include Africa's first offshore wind farm*. Retrieved from Recharge News: <https://www.rechargenews.com/energy-transition/new-10gw-green-hydrogen-project-in-mauritania-could-include-africas-first-offshore-wind-farm/2-1-1074316>
- Collins, L. (2022). *World's largest green hydrogen project unveiled in Texas, with plan to produce clean rocket fuel for Elon Musk*. Retrieved from <https://www.rechargenews.com/energy-transition/world-s-largest-green-hydrogen-project-unveiled-in-texas-with-plan-to-produce-clean-rocket-fuel-for-elon-musk/2-1-1178689>
- CORDIS. (2022). *EU-Funded projects since 1990. CORDIS EU Research results, Community Research and Development Information Service*. Retrieved 2022, from <https://cordis.europa.eu/projects>
- Cresswell, J. (2020). *Norway pilots hydrogen-fuelled offshore service vessel development*. Retrieved from <https://www.energyvoice.com/renewables-energy-transition/hydrogen/274642/norway-pilots-hydrogen-fuelled-offshore-service-vessel-development/>
- Delpierre, M., Quist, J., Mertens, J., Prieur-Vernat, A., & Cucurachi, S. (2021). Assessing the environmental impacts of wind-based hydrogen production in the Netherlands using ex-ante LCA and scenarios analysis. *Journal of Cleaner Production*, 299, p. 1268.
- Derwent, R. (2018). *Hydrogen for heating: Atmospheric impacts - A literature review*. Department for Business, Energy & Industrial Strategy.
- Derwent, R., Stevenson, D., Utembe, S., Jenkin, M., Khan, A., & Shallcross, D. (2020). Global modelling studies of hydrogen and its isotopomers using STOCHEM-CRI: Likely radiative forcing consequences of a future hydrogen economy. *International Journal of Hydrogen Energy*, 45(15), pp. 9211-9221.
- DFDS. (2020). *Fuel cell testing moves forward on Ark Germania*.
- Djunisic, S. (2022). *Chile's HyEx green H2, ammonia project gets enviro approval*. Retrieved from <https://renewablesnow.com/news/chiles-hyex-green-h2-ammonia-project-gets-enviro-approval-782597/>
- DNV GL. (2017). *Study on the Use of Fuel Cells in Shipping*. European Maritime Safety Agency (EMSA).
- DNV GL. (2019). *Comparison of Alternative Marine Fuels*. SEALNG.
- DNV GL. (2019). *Comparison of Alternative Marine Fuels*. SEA LNG.
- EC. (2003, 10 25). *DIRECTIVE 2003/87/EC - Annex IV*. Retrieved from Directive establishing a scheme for greenhouse gas emission allowance trading within the Community: <https://eur-lex.europa.eu/legal-content/EN/TXT/PDF/?uri=CELEX:32003L0087&from=EN>



- EC. (2009). *Directive 2009/28/EC Renewable Energy Directive*. Official Journal of the European Union.
- EC. (2018). *Directive (EU) 2018/2001 Recast Renewable Energy Directive (RED II)*. Official Journal of the European Union.
- EC. (2020). *2030 Climate Target Plan; Published Initiatives, Law, European Commission*. Retrieved 2022, from [https://ec.europa.eu/info/law/better-regulation/have-your-say/initiatives/12265-2030-Climate-Target-Plan\\_en](https://ec.europa.eu/info/law/better-regulation/have-your-say/initiatives/12265-2030-Climate-Target-Plan_en)
- EC. (2021a). *Assessment of impacts from accelerating the uptake of sustainable alternative fuels in maritime transport*. Brussels, BE: European Commission.
- EC. (2021b). *Commission presents Renewable Energy Directive revision*. Retrieved 2022, from European Commission: [https://ec.europa.eu/info/news/commission-presents-renewable-energy-directive-revision-2021-jul-14\\_en](https://ec.europa.eu/info/news/commission-presents-renewable-energy-directive-revision-2021-jul-14_en)
- EC. (2021c). Proposal for a Regulation of the European Parliament and of the Council on the use of renewable and low-carbon fuels in maritime transport and amending Directive 2009/16/EC.
- EC. (2021d). *Proposal revision EU ETS*. Brussels, BE: European Commission.
- EC. (2021e). *Study on EU ETS for maritime transport and possible alternative options of combinations to reduce greenhouse gas emissions*. Retrieved from EU publications: <https://op.europa.eu/en/publication-detail/-/publication/ba865136-353b-11ec-bd8e-01aa75ed71a1>
- Elizabeth Queen Swann. (2021). *MF HYDRA - LH2 CAR FERRY, NORWAY*. Retrieved from [http://elizabethqueenseaswann.com/HISTORY/LH2\\_Ships\\_Ferries\\_Yachts\\_Hydrogen\\_Projects/MF\\_Hydra\\_Norled\\_Car\\_Ferry\\_Norway\\_Liquefied\\_Hydrogen\\_Liquide.html](http://elizabethqueenseaswann.com/HISTORY/LH2_Ships_Ferries_Yachts_Hydrogen_Projects/MF_Hydra_Norled_Car_Ferry_Norway_Liquefied_Hydrogen_Liquide.html)
- ENGIE. (2021). *Developing a 100 MW hydrogen production hub in Sines, Portugal*. Retrieved from <https://www.engie.com/en/news/green-H2-atlantic-hydrogen>
- Errard, A., Diaz-Alonso, F., & Goll, M. (2021). *Electrical capacity for wind and solar photovoltaic power - statistics*. Retrieved March 2021, from [https://ec.europa.eu/eurostat/statistics-explained/index.php?title=Electrical\\_capacity\\_for\\_wind\\_and\\_solar\\_photovoltaic\\_power\\_-\\_statistics](https://ec.europa.eu/eurostat/statistics-explained/index.php?title=Electrical_capacity_for_wind_and_solar_photovoltaic_power_-_statistics)
- EU. (2018). Directive (EU) 2018/2001 of the European Union and of the Council 11 December 2018 on the promotion of the use of energy from renewable sources. Official Journal of the European Union. Retrieved from [https://eur-lex.europa.eu/legal-content/EN/TXT/?uri=uriserv:OJ.L\\_.2018.328.01.0082.01.ENG&toc=OJ:L:2018:328:TOC](https://eur-lex.europa.eu/legal-content/EN/TXT/?uri=uriserv:OJ.L_.2018.328.01.0082.01.ENG&toc=OJ:L:2018:328:TOC)
- Eurostat. (2020). *Euro/ECU exchange rates - annual data*. Retrieved 11 04, 2021, from [https://appsso.eurostat.ec.europa.eu/nui/show.do?dataset=ert\\_bil\\_eur\\_a&lang=en](https://appsso.eurostat.ec.europa.eu/nui/show.do?dataset=ert_bil_eur_a&lang=en)
- Faber, J., Hanayama, S., Zhang, S., Pereda, P., Comer, B., & et al. (2020). *Fourth IMO Greenhouse Gas Study 2020*. London: International Maritime Organization. Retrieved from <https://www.imo.org/en/OurWork/Environment/Pages/Fourth-IMO-Greenhouse-Gas-Study-2020.aspx>
- Fahnestock, J., & Bingham, C. (2021). *Mapping of Zero Emission Pilots and Demonstration Projects*. Getting to Zero Coalition and Global Maritime Forum.
- Fahnestock, J., & Bingham, C. (2021). *Mapping of Zero Emission Pilots and Demonstration Projects*.
- Field, R., & Derwent, R. (2021). Global warming consequences of replacing natural gas with hydrogen in the domestic energy sectors of future low-carbon economies in the United Kingdom and the United States of America. *International Journal of Hydrogen Energy*, 46(30).
- Final consumption*. (2018). Retrieved October 25, 2021, from <https://www.iea.org/reports/key-world-energy-statistics-2020/final-consumption>
- Flexens. (2020). *Hydrogen ferries might soon traffic the Baltic Sea*. Retrieved from <https://flexens.com/hydrogen-ferries-might-soon-traffic-the-baltic-sea/>
- Forster, P., et al. (2007). Changes in Atmospheric Constituents and in Radiative Forcing. In Solomon, S., et al. (Ed.), *Climate Change 2007: The Physical Science Basis. Contribution of Working Group I to the Fourth*

- Assessment Report of the Intergovernmental Panel on Climate Change*. Cambridge: Cambridge University Press.
- Frazer-Nash Consultancy. (2022). *Fugitive Hydrogen Emissions in a Future Hydrogen Economy*. Department for Business, Energy & Industrial Strategy.
- Froehlich, H., Afflerbach, J., Frazier, M., & Halpern, B. (2019). Blue growth potential to mitigate climate change through seaweed offsetting. *Current Biology*, 29, 3087.
- FuelCellsWorks. (2022). *Nine of the Largest Green Hydrogen Projects of 2022*. Retrieved from <https://fuelcellsworks.com/news/nine-of-the-largest-green-hydrogen-projects-2022/>
- FuelCellsWorks. (2022). *Work Starts at World's Largest Green Hydrogen Project in NEOM With a \$900m EPC Contract*. Retrieved from <https://fuelcellsworks.com/news/work-starts-at-worlds-largest-green-hydrogen-project-in-neom-with-a-900m-epc-contract/>
- Gard. (2020). *South Korea implements additional emission reduction initiatives in major port areas*. Retrieved 2022, from <https://www.gard.no/web/updates/content/29847462/south-korea-implements-additional-emission-reduction-initiatives-in-major-port-areas>
- Garraín, D., & Lechón, Y. (2014). Exploratory environmental impact assessment of the manufacturing and disposal stages of a new PEM fuel cell. *International journal of hydrogen energy*, 39(4), pp. 1769-1774.
- Georgina Jeerh, M. Z. (2021). Recent progress in ammonia fuel cells and their potential applications. *Journal of Materials Chemistry*, A(2), 499.
- Ghavam, S., Vahdati, M., Grant Wilson, I. A., & Styring, P. (2021). Sustainable Ammonia Production Processes. *Frontiers in Energy Research*, 9. doi:<https://doi.org/10.3389/fenrg.2021.580808>
- Ghavam, S., Vahdati, M., Wilson, I. A., & Styring, P. (2021). Sustainable ammonia production processes. *Frontiers in Energy Research*, 9(34).
- Global Maritime Forum. (2022). *Getting to Zero Coalition*. *Energy Transition, Global Marine Forum*. Retrieved 2022, from <https://www.globalmaritimeforum.org/getting-to-zero-coalition>
- Gollakota, A., Kishore, N., & Gu, S. (2018). *A review on hydrothermal liquefaction of biomass*. *Renewable and Sustainable Energy Reviews*, 81(1), 1378-1392.
- Green Car Congress. (2022). *HyMethShip seeks to fuel ship engines with hydrogen from methanol*. Retrieved from <https://www.greencarcongress.com/2022/07/20220702-hymethship.html>
- Green H2 Atlantic. (2022). *Green H2 Atlantic*. Retrieved from <https://www.greenh2atlantic.com/>
- Green Shipping Programme. (2020). *High-speed hydrogen-powered passenger vessels*. Retrieved from <https://greenshippingprogramme.com/pilot/high-speed-hydrogen-powered-passanger-vessels/>
- GREENEA. (2016). *Analysis of the current development of household UCO collection systems in the EU*. International Council on Clean Transportation. Retrieved from [https://theicct.org/wp-content/uploads/2021/06/Greenea-Report-Household-UCO-Collection-in-the-EU\\_ICCT\\_20160629.pdf](https://theicct.org/wp-content/uploads/2021/06/Greenea-Report-Household-UCO-Collection-in-the-EU_ICCT_20160629.pdf)
- Gregory D. Boardman, S. M. (2004). Toxicity of ammonia to three marine fish and three marine invertebrates. *Environmental Toxicology*, 19(2), 8.
- Grimm, A., de Jong, W., & Kramer, G. (2020). Renewable hydrogen production: A techno-economic comparison of photoelectrochemical cells and photovoltaic-electrolysis. *International Journal of Hydrogen Energy*, pp. 22545-22555.
- H2 Energy Europe. (2021). *H2 Energy Esbjerg*. Retrieved from <https://h2energy.ch/en/esbjerg/>
- H2 Energy Europe. (2021, September). *Major green hydrogen power-to-X facility planned in Esbjerg*. Retrieved from <https://h2energy.ch/en/2021/09/23/major-green-hydrogenpower-to-x-facility-planned-in-esbjerg/>
- Hendriksen, P. V., Sørensen, T. A., & Münster, M. (2021). *MarE-Fuel: Sustainable Maritime Fuels*. Technical University of Denmark.
- Hollands, C. (2022). *Mauritania's Advances 30 GW Hydrogen Project*. Retrieved from <https://energycapitalpower.com/mauritania-30gw-green-hydrogen-cwp-deal/>

- Horvath. (2017). *Techno-Economic Analysis of a Decarbonized Shipping Sector: Technology Suggestions for a Fleet in 2030 and 2040*. Lappeenranta, Finland: Lappeenranta University of Technology.
- HyMethShip. (2019, March). *Hydrogen in combustion engines*. Retrieved from [https://www.interreg-danube.eu/uploads/media/approved\\_project\\_public/0001/39/8da6a298e2b7c17df4da9c2768055b3457ea87bc.pdf](https://www.interreg-danube.eu/uploads/media/approved_project_public/0001/39/8da6a298e2b7c17df4da9c2768055b3457ea87bc.pdf)
- HyResource. (2022). *Asian Renewable Energy Hub*. Retrieved from <https://research.csiro.au/hyresource/asian-renewable-energy-hub/>
- HyResource. (2022). *H2-Hub Gladstone*. Retrieved from <https://research.csiro.au/hyresource/h2-hub-gladstone/>
- HyResource. (2022). *HyEnergy Project*. Retrieved from <https://research.csiro.au/hyresource/hyenergy-project/>
- HyResource. (2022). *Murchison Hydrogen Renewables Project*. Retrieved from <https://research.csiro.au/hyresource/murchison-hydrogen-renewables-project/>
- HyResource. (2022). *Western Green Energy Hub*. Retrieved from <https://research.csiro.au/hyresource/western-green-energy-hub/>
- Hyseas III. (n.d.). *The Project*. Retrieved from <https://www.hyseas3.eu/the-project/>
- IBIA. (2022). *IBIA's Future Fuels Working Group - Assessment*. Retrieved April 2022, from <https://ibia.net/2022/03/04/ibias-future-fuels-working-group-assessment/>
- IEA. (2017). *Renewable Energy for Industry: From green energy to green materials and fuels*. Paris: IEA/OECD.
- IEA. (2019). *The Future of Hydrogen: Seizing today's opportunities*.
- IEA. (2020). *Final Consumption*. Retrieved October 25, 2021, from <https://www.iea.org/reports/key-world-energy-statistics-2020/final-consumption>
- IEA. (2020). *Outlook for biogas and biomethane: prospects for organic growth*. International Energy Agency.
- IEA. (2020). *Renewables 2020 - Analysis and Forecast to 2025*. International Energy Agency.
- IEA. (2021). *Could the green hydrogen boom lead to additional renewable capacity by 2026?* Retrieved October 2022, from <https://www.iea.org/articles/could-the-green-hydrogen-boom-lead-to-additional-renewable-capacity-by-2026>
- IEA. (2021). *Global Hydrogen Review 2021*. International Energy Agency.
- IEA. (2021). *Natural Gas Information: Overview*. Paris: International Energy Agency. Retrieved from <https://www.iea.org/reports/natural-gas-information-overview>
- IEA. (2021). *World Energy Outlook 2021*. Paris: International Energy Agency. Retrieved from <https://www.iea.org/reports/world-energy-outlook-2021>
- IEA. (2022). *Global Hydrogen Review 2022*.
- IEA. (2022, October). *projects database*. Retrieved from Hydrogen Projects Database: <https://www.iea.org/data-and-statistics/data-product/hydrogen-projects-database>
- IEA WEB. (2020). *World Energy Balances*. IEA.
- IMO. (2020). *Fourth IMO GHG Study 2020*. London, UK: International Maritime Organization.
- IMO. (2021). *Informal discussions focus on lifecycle GHG/carbon intensity of cleaner fuels for shipping*. Retrieved April 2022, from <https://www.imo.org/en/MediaCentre/Pages/WhatsNew-1603.aspx>
- IMPCA. (2015). *IMPCA Methanol Reference Specifications*. International Methanol Producers & Consumers Association.
- Intercontinental Energy. (2022). *Asian Renewable Energy Hub*. Retrieved from <https://intercontinentalenergy.com/asian-renewable-energy-hub>
- IPCC. (2006). *IPCC Guidelines for National Greenhouse Gas Inventories*. Intergovernmental Panel on Climate Change.
- IPCC. (2021). *Climate Change 2021: The Physical Science Basis*.

- IRENA. (2020). *Renewable Energy Highlights*. International Renewable Energy Agency.
- IRENA. (2021). *A pathway to decarbonise the shipping sector by 2050*. Abu Dhabi: International Renewable Energy Agency.
- IRENA and Methanol Institute. (2021). *Innovation Outlook: Renewable Methanol*. International Renewable Energy Agency.
- ISO. (2017). *8217 - Petroleum products - Fuels (class F) - Specifications of marine fuels*. International Standardization Organization.
- ISPT. (2019). *HYCHAIN – ENERGY CARRIERS AND HYDROGEN SUPPLY CHAIN*. Retrieved October 2021, from <https://ispt.eu/publications/si-20-06-hychain-3-database/>
- JRC. (2022). *Hydrogen emissions from a hydrogen economy and their potential global warming impact*.
- JSTRA. (2020). *Roadmap to Zero Emission from International Shipping*. Japan Ship Technology Research Association. Retrieved from <https://www.mlit.go.jp/common/001354314.pdf>
- Kalavasta. (2019). *HyChain 2 - Cost implications of importing renewable electricity, hydrogen and hydrogen carriers into the Netherlands from a 2050 perspective*.
- Kass, M. D., Sluder, C. S., & Kaul, B. C. (2021). *ORNL/SPR-2021/1837 Spill Behavior, Detection, and Mitigation for Emerging Nontraditional Marine Fuels*. Oak Ridge: Oak Ridge National Laboratory.
- Kim, K., Roh, G., Kim, W., & Chun, K. (2020). A Preliminary Study on an Alternative Ship Propulsion System Fueled by Ammonia: Environmental and Economic Assessments. *Journal of Marine Science and Engineering*.
- Kim, K., Roh, G., Kim, W., & Chun, K. (2020). A preliminary study on an alternative ship propulsion system fueled by ammonia: Environmental and economic assessments. *Journal of Marine Science and Engineering*, 8(3), 183.
- Klevstrand, A. (2022, November). *Partners to spend more than €1bn on 500MW-plus green hydrogen project in Portugal*. Retrieved from <https://www.hydrogeninsight.com/production/partners-to-spend-more-than-1bn-on-500mw-plus-green-hydrogen-project-in-portugal/2-1-1353788>
- Korberg, A. D., Brynolf, S., Grahnbl, M., & Skova, R. (2021). Techno-economic assessment of advanced fuels and propulsion systems in future fossil-free ships. *Renewable and Sustainable Energy Reviews*.
- Laursen, R., Barcarolo, D., Patel, H., Dowling, M., Penfold, M., Faber, J., . . . Pang, E. (2022). *Potential of Ammonia as Fuel in Shipping*. Lisbon: European Maritime Safety Agency.
- LBST and Hincio. (2015). *Study on hydrogen from renewable sources in the EU*.
- Lehahn, Y., Nivrutti Ingle, K., & Golberg, A. (2016). Global potential of offshore and shallow waters macroalgal biorefineries to provide for food, chemicals and energy: feasibility and sustainability. *Algal Research*, 17, 150-160.
- Lewis, A. (2021). Optimising air quality co-benefits in a hydrogen economy: a case for hydrogen-specific standards for NO<sub>x</sub> emissions. *Environmental Science: Atmospheres*, 1(5), pp. 201-207.
- Maersk. (2022). *A.P. Moller - Maersk engages in strategic partnerships across the globe to scale green methanol production by 2025*. Copenhagen, Denmark: Maersk.
- Maersk. (2022). *News*. Retrieved 2022, from <https://www.maersk.com/news>
- Maire Tecnimont. (2021). Maire Tecnimont Group reaches agreement with Greenfield Nitrogen LLC for the development of a green ammonia plant in the United States. Retrieved from <https://www.mairetecnimont.com/en/media/press-releases/maire-tecnimont-group-reaches-agreement-greenfield-nitrogen-llc-development-green-ammonia-plant>
- MAN Energy Solutions. (2018). *Costs and benefits of alternative fuels for an LRI Product Tanker*. Denmark: MAN Energy Solutions.
- MAN Energy Solutions. (2022). *Project cost estimates in each vessel class*. Germany: MAN Energy Solutions.

- Man Energy Solutions. (n.d.). *Are hydrogen-powered solutions the sea change required for a decarbonized maritime sector?* Retrieved from <https://www.ship-technology.com/news/mol-hydrogen-powered-engine/>
- MAN ES. (2022). *The world's first two-stroke methanol engine*. Retrieved from <https://www.man-es.com/marine/products/man-b-w-me-lgim>
- Marin. (2020, March 20). Assessment and selection of Sustainable Alternative Power for Shipping, Presentation at ESSF.
- Marin. (2023, February 1). *Sustainable Power @ Marin*. Retrieved from Energy Carriers: <https://sustainablepower.application.marin.nl/energy-carriers>
- Marion, G., Millero, F., Camoes, M., Spitzer, P., Feistel, R., & Chen, C.-T. (2011). pH of seawater. *Marine Chemistry*, 126, 89-96. doi:<https://doi.org/10.1016/j.marchem.2011.04.002>
- MARPOL. (2017). *Articles, Protocols, Annexes and Unified Interpretations of the International Convention for the Prevention of Pollution from Ships, 1973, as modified by the 1978 and 1997 Protocols*. International Maritime Organization.
- Mayer, S. (2019). *Congress Paper 169 NOx Reduction to Tier III Levels on MAN B&W LGI Low-Speed Engines by Water Addition to Either Methanol or Conventional Diesel Fuel Oil*. Vancouver: MAN Energy Solutions.
- McKinsey & Company. (2021). *How hydrogen combustion engines can contribute to zero emissions*.
- McKinsey and Company. (2023). *Land: A crucial resource for the energy transition*. Retrieved from <https://www.mckinsey.com/industries/electric-power-and-natural-gas/our-insights/land-a-crucial-resource-for-the-energy-transition#/>
- McPhy. (2021). *30 energy players initiate an integrated value chain to deliver green hydrogen across Europe at the price of fossil fuels*. Retrieved 2022, from <https://mcphy.com/en/news/hydeal-ambition/?cn-reloaded=1>
- MCS.1/Circ.1599. (2019). *Interim Guidelines on the Application of High Manganese Austenitic Steel for Cryogenic Service*.
- Melitos, G., Voukopoulos, X., & Zabaniotou, A. (2021). Waste to Sustainable Biohydrogen Production Via Photo-Fermentation and Biophotolysis— A Systematic Review. *Renewable Energy and Environmental Sustainability*(6), p. 45.
- MEPC. (2018). *Resolution MEPC.308(73) 2018 Guidelines on the Method of Calculation of the Attained Energy Efficiency Design Index (EEDI) for New Ships*. IMO Maritime Environmental Protection Committee.
- Methanol Institute. (2018). *ISO specification is another step forward for Methanol as marine fuel*. Methanol Institute. Retrieved from <https://www.methanol.org/wp-content/uploads/2020/04/MI-IMO-ISO-PR-Final.pdf>
- MSC.1/Circ.1622. (2020). *Guidelines for the Acceptance of Alternative Metallic Materials for Cryogenic Service in Ships Carrying Liquefied Gases in Bulk and Ships using Gases or other Low-Flashpoint Fuels*.
- Münster, M. (2021). *Electro fuels for long-range maritime transport*. DTU Orbit.
- Myrhe, G., et al. (2014). Anthropogenic and Natural Radiative Forcing. In Stocker, T.F., et al. (Ed.), *Climate Change 2013: The Physical Science Basis. Contribution of Working Group I to the Fifth Assessment Report of the Intergovernmental Panel on Climate Change*. Cambridge: Cambridge University Press.
- Nami, H., Butera, G., Campion, N., Frandsen, H., & Hendriksen, P. (2021). *MarE-fuel: Energy efficiencies in synthesising green fuels and their expected cost*. Technical University of Denmark.
- Nikolaidis, P., & Poullikkas, A. (2017). A comparative overview of hydrogen production processes. *Renewable and sustainable energy reviews*.
- NorthH2. (2022). *Kickstarting the Green Hydrogen Economy*. Retrieved from <https://www.north2.eu/>
- NS Energy Business. (2021). *Sinopec breaks ground on \$470m PV green hydrogen project in China*. Retrieved from <https://www.nsenerybusiness.com/news/sinopec-pv-green-hydrogen-production-project-kuqa/>
- OCIMF. (2019). *Joint Industry Guidance - The supply and use of 0.50% sulphur marine fuel*. OCIMF. Retrieved from <https://www.ocimf.org/publications/information-papers/joint-industry-guidance-the-supply-and-use-of-0-50-sulphur-marine-fuel#:~:text=other%20industry%20organisations->

,Joint%20Industry%20Guidance%20%2D%20The%20supply%20and%20use,0.50%25%2Dsulphur%20marine%

- Ocko, I., & Hamburg, S. (2022). Climate consequences of hydrogen emissions. *Atmospheric Chemistry and Physics*.
- OQ. (2022). *Green Energy Oman takes key project development steps to progress the world leading green fuels project*. Retrieved from <https://oq.com/en/news-and-media/newsroom/20220413-green-energy-oman-takes-key-project-development-steps>
- Papadokonstantakis, S. (2019). *D3.2 Definition of biomass reference technologies with respect to TRL and performance indicators*.
- Parkinson, B. B. (2019). Levelized cost of CO<sub>2</sub> mitigation from hydrogen production routes. *Energy & environmental science*, 12(1), 19-40.
- (2020). *Path to hydrogen competitiveness. A cost perspective*. Hydrogen Council.
- Politi, D. (2021, November). *Fortescue plans Argentina green hydrogen project*. Retrieved from Argus Media: <https://www.argusmedia.com/en/news/2270376-fortescue-plans-argentina-green-hydrogen-project>
- Polychroniou, G. (2022, March). *White Dragon: Important Projects of Common European Interest on Hydrogen*. Retrieved from <https://hydrogeneurope.eu/wp-content/uploads/2022/04/George-Polychron-White-Dragon-Lighthouse-Initiative-30March.pdf>
- Prevljak, N. H. (2022). *Energy Observer unveils zero-emission, LH<sub>2</sub>-powered cargo ship concept*. Retrieved from <https://www.offshore-energy.biz/energy-observer-unveils-lh2-powered-cargo-ship-concept/#:~:text=French%20project%20Energy%20Observer%20is,high%20transport%20capacities%20and%20autonomy>.
- Prevljak, N. H. (2022). *SeaShuttle hydrogen-fuelled containership project wins Enova funding*. Retrieved from <https://www.offshore-energy.biz/seashuttle-hydrogen-fuelled-containership-project-wins-enova-funding/>
- Province Resources Limited. (2022). *Completion of Scoping Study Allows HyEnergy™ Green*. Retrieved from <http://wcsecure.weblink.com.au/pdf/PRL/02494415.pdf>
- PV Magazine. (2022). *Fortescue proposes 9.2 GW green hydrogen project in Egypt*. Retrieved from <https://www.pv-magazine.com/2022/09/12/fortescue-proposes-9-2-gw-green-hydrogen-project-in-egypt/>
- Queensland Government. (2022). *H<sub>2</sub>-Hub Gladstone*. Retrieved from <https://www.statedevelopment.qld.gov.au/coordinator-general/assessments-and-approvals/coordinated-projects/current-projects/h2-hub-gladstone>
- Radowitz, B. (2021, August 24). *'Very disruptive' direct solar-to-hydrogen commercially viable by 2030, says oil group Repsol*. Retrieved from <https://www.rechargenews.com/energy-transition/very-disruptive-direct-solar-to-hydrogen-commercially-viable-by-2030-says-oil-group-repsol/2-1-1056771>
- Rec-kaz. (2021). *REC Renewable Energy Qazaqstan*. Retrieved from <https://www.rec-kaz.net/>
- Roser, H. R. (2017). *Energy Production and Consumption*. Retrieved October 25, 2021, from <https://ourworldindata.org/energy-production-consumption>
- Rouwenhorst, K. H., Van der Ham, A. G., Mul, G., & Kersten, S. R. (2019). Islanded ammonia power systems: Technology review & conceptual process design. *Renewable and Sustainable Energy Reviews*, 114(109339).
- RWE. (n.d.). *Hytech Hafen Rostock*. Retrieved from <https://www.rwe.com/en/research-and-development/hydrogen-projects/hytech-hafen-rostock>
- S&P Global. (2021). *Danish companies plan 1.3-GW green hydrogen project to fuel transport*. Retrieved from <https://www.spglobal.com/commodityinsights/en/oil/refined-products/jetfuel/052620-danish-companies-plan-13-gw-green-hydrogen-project-to-fuel-transport>
- SA. (2020). *ME-093 Hydrogen Technologies Strategic Work Plan*. Standards Australia. Retrieved from <https://www.standards.org.au/getmedia/da6c6fcb-96bb-4b45-a1b0-1f2882c03ec4/ME-093-Hydrogen-Technologies-Strategic-Work-Plan.pdf.aspx>

- Scully, J. (2022, September 12). *Fortescue eyes green hydrogen project with 9.2GW of solar and wind in Egypt*. Retrieved from PV-Tech: <https://www.pv-tech.org/fortescue-eyes-green-hydrogen-project-with-9-2gw-of-solar-and-wind-in-egypt/>
- Seroff, N. (2020). *Danish companies join forces on an ambitious sustainable fuel project*.
- Ship Technology. (2021). *MOL and team to conduct trial of hydrogen-powered engine*. Retrieved from <https://www.ship-technology.com/news/mol-hydrogen-powered-engine/>
- Shipandbunker. (2022). *Rotterdam Bunker Prices*. Retrieved 05 26, 2022, from <https://shipandbunker.com/prices/emea/nwe/nl-rtm-rotterdam>
- Smith, C., Hill, A. K., & Torrente-Murciano, L. (2020). Current and future role of Haber–Bosch ammonia in a carbon-free energy landscape. *Energy & Environmental Science*, 13(2), 331-344.
- SOLAS. (2020). *Consolidated text of the International Convention for the Safety of Life at Sea, 1974, and its Protocol of 1988: articles, annexes and certificates*. International Maritime Organization.
- Song, S. (2017). *A Clean Air Challenge for China's Ports: Cutting Maritime Emissions*. World Resources Institute.
- Sørensen, T. A., & Laursen, R. (2021). *TOTAL COST OF OWNERSHIP (TCO) - Sustainable Maritime Fuels - MAR-E-FUEL Project*. Copenhagen, DK: Danish Technical University.
- State of Green. (2021, February). *Europe's largest PtX facility to be built in Esbjerg, Denmark*. Retrieved from <https://stateofgreen.com/en/news/europes-largest-ptx-facility-to-be-built-in-esbjerg-denmark/>
- Statista. (2021). *Largest proposed green hydrogen production projects worldwide based on electrolyzer capacity as of August 2021*. Retrieved from <https://www.statista.com/statistics/1011849/largest-planned-green-hydrogen-projects-worldwide/>
- Stepanenko, D., & Kneba, Z. (2019). DME as alternative fuel for compression ignition engines - a review. *Combustion Engines*, 177(2), 172-179.
- Stropnik, R., Lotrič, A., Bernad Montenegro, A., Sekavčnik, M., & Mori, M. (2019). Critical materials in PEMFC systems and a LCA analysis for the potential reduction of environmental impacts with EoL strategies. *Energy Science & Engineering*, 7(6), p. 2519.
- Styring, P., George, G., & Tozer, I. (2021). Synthetic Fuels Based on Dimethyl Ether as a Future Non-Fossil Fuel for Road Transport From Sustainable Feedstocks. *Frontiers in Energy Research*, 663331, 9.
- Tamburic, B., Dechatiwongse, P., Zemichael, F., Maitland, G., & Hellgardt, K. (2013). Process and reactor design for biophotolytic hydrogen production. *Physical Chemistry Chemical Physics*, 15(26), 10783-10794.
- TNO. (2020a). *Power-2-Fuel Cost Analysis*. The Hague, NL: TNO.
- TNO. (2020b). *Green Maritime Methanol Operation aspects and the fuel supply chain*. The Hague, NL: TNO.
- Tomas Tronstad, H. H. (2017). *Study on the use of Fuel Cells in Shippin*. Copenhagen: Cero 2050.
- Turney, D., & Fthenakis, V. (2011). Environmental impacts from the installation and operation of large-scale solar power plants. *Renewable and Sustainable Energy Reviews*, 15(6), pp. 3261-3270.
- Ulstein. (2019). *ZERO-EMISSION OPERATIONS IN OFFSHORE CONSTRUCTION MARKET*. Retrieved from <https://ulstein.com/news/zero-emission-operations-in-offshore-construction-market>
- United States. (2013). *Testing and Recommended Practices to Improve Nurse Tank Safety, Phase I*. Retrieved from <https://rosap.ntl.bts.gov/view/dot/168>
- USCG. (2015). *Strategy for Waterside Security of Especially Hazardous Cargo*. United States Coast Guard.
- Wärtsilä. (2022). *Wärtsilä two-stroke future fuels conversion*. Wärtsilä.
- Warwick, N., Griffiths, P., Keeble, J., Archibald, A., Pyle, J., & Shine, K. (2022). *Atmospheric implications of increased Hydrogen use*.
- Wesley, Cole, Frazier, A. W., & Augustine, C. (2021). *Cost Projections for Utility-Scale Battery Storage: 2021 Update*. Golden, Colorado, US: National Renewable Energy Laboratory.

- WHO. (2022). *Health Topics: Air Pollution*. Retrieved 2022, from [https://www.who.int/health-topics/air-pollution#tab=tab\\_1](https://www.who.int/health-topics/air-pollution#tab=tab_1)
- Wong, K. F. (2022). *Energy Intelligence*. Retrieved from <https://www.energyintel.com/00000181-8613-d35b-a7eb-a65b59120000>
- World Fuel Services. (2017). ISO 8217 2017.
- World-Energy. (2020). *Gigawatt-Scale: The world's 13 Largest Green-Hydrogen Projects*. Retrieved from <https://www.world-energy.org/article/14732.html>
- Yakaboylu, O., Harinck, J., Smit, K., & De Jong, W. (2015). Supercritical water gasification of biomass: a literature and technology overview. *Energies*, 8(2), pp. 859-894.
- Yusef Bicer, I. D. (2017, May). Impact Assessment and Environmental Evaluation of Various Ammonia Production Processes. *Environmental Management*, 59(5). Retrieved from [https://www.researchgate.net/publication/313732136\\_Impact\\_Assessment\\_and\\_Environmental\\_Evaluation\\_of\\_Various\\_Ammonia\\_Production\\_Processes](https://www.researchgate.net/publication/313732136_Impact_Assessment_and_Environmental_Evaluation_of_Various_Ammonia_Production_Processes)
- Zwart, R., & van Ree, R. (2008). *Bio-based Fischer-Tropsch diesel production technologies*. Energy Research Centre of the Netherlands (ECN). ECN-08-012.



## Appendix I – Symbols, Abbreviations and Acronyms

<b>ABS</b>	American Bureau of Shipping
<b>AER</b>	Annual Efficiency Ratio (IMO)
<b>AFC</b>	Alkaline Fuel Cell
<b>AIP</b>	Approval In Principle
<b>ALARP</b>	As Low As Reasonably Practical
<b>ANSI</b>	American National Standards Institute
<b>API</b>	American Petroleum Institute
<b>ASME</b>	American Society of Mechanical Engineers
<b>ASTM</b>	American Society for Testing of Materials
<b>ATR</b>	AutoThermal Reforming
<b>BDN</b>	Bunker Delivery Note
<b>BMEP</b>	Brake Mean Effective Pressure
<b>BOG</b>	Boil Off Gas
<b>BOR</b>	Boil-Off Rate
<b>CAPEX</b>	Capital Expenditure
<b>CCC</b>	Carriage of Cargoes and Containers Sub-Committee (IMO)
<b>CCPV</b>	Carbon Composite Pressure Vessel
<b>CCR</b>	California Code of Regulation
<b>C<sub>F</sub></b>	Fuel-Conversion Factor (IMO - EEDI)
<b>CFR</b>	Code of Federal Regulations
<b>CHP</b>	Combined Heat and Power
<b>CII</b>	Carbon Intensity Indicator (IMO)
<b>CIMAC</b>	International Council on Combustion Engines
<b>CNG</b>	Compressed Natural Gas
<b>CO</b>	Carbon Monoxide
<b>CO<sub>2</sub></b>	Carbon Dioxide
<b>CO<sub>2e</sub></b>	Carbon Dioxide Equivalent
<b>DCS</b>	Data Collection System (IMO)
<b>DDT</b>	Deflagration to Detonation Transition
<b>DF</b>	Dual Fuel
<b>DFDE</b>	Dual Fuel Diesel Electric
<b>DOT</b>	Department of Transport
<b>DPF</b>	Diesel Particulate Filter
<b>DWT</b>	Deadweight Tonnage
<b>ECA</b>	Emission Control Area
<b>EEA</b>	Exhaust Emission Abatement
<b>EEBD</b>	Emergency Escape Breathing Devices
<b>EEDI</b>	Energy Efficiency Design Index (IMO)
<b>EEOI</b>	Energy Efficiency Operational Index (IMO)
<b>EEEXI</b>	Energy Efficiency Existing Ship Index (IMO)
<b>EEZ</b>	Exclusive Economic Zone
<b>EGR</b>	Exhaust Gas Recirculation
<b>EIAPPC</b>	Engine International Air Pollution Prevention Certificate (IMO)

<b>EMSA</b>	European Maritime Safety Agency
<b>EN</b>	European Standards (European Norm)
<b>EPA</b>	Environmental Protection Agency
<b>ESD</b>	Emergency Shutdown
<b>EU</b>	European Union
<b>FAT</b>	Factory Acceptance Test
<b>FGSS</b>	Fuel Gas Supply System
<b>FMEA</b>	Failure Mode and Effects Analysis
<b>FMECA</b>	Failure Mode, Effects and Criticality Analysis
<b>FOC</b>	Fuel Oil Consumption
<b>FPR</b>	Fuel-Preparation Room
<b>FSS</b>	Fuel Supply System
<b>FT</b>	Fischer-Tropsch
<b>GESAMP</b>	Group of Experts on the Scientific Aspect of Marine Environmental Protection
<b>GFS</b>	Gas-Fuelled Ship
<b>GHG</b>	Green House Gas
<b>GISIS</b>	Global Integrated Ship Information System (IMO)
<b>GVT</b>	Gas Valve Train
<b>GVU</b>	Gas Valve Unit
<b>GWP</b>	Global Warming Potential
<b>HAZID</b>	Hazard Identification Studies
<b>HAZOP</b>	Hazard and Operability Study
<b>HB</b>	Haber-Bosch
<b>HC</b>	Hydrocarbon
<b>HDPE</b>	High-Density Polyethylene
<b>HFO</b>	Heavy Fuel Oil
<b>HP</b>	High Pressure
<b>IACS</b>	International Association of Classification Societies
<b>IAPPC</b>	International Air Pollution Prevention Certificate (IMO)
<b>IBIA</b>	International Bunker Industry Association
<b>IC</b>	Internal Combustion
<b>ICE</b>	Internal Combustion Engine
<b>IEA</b>	International Energy Agency
<b>IEC</b>	International Electrotechnical Commission
<b>IGC</b>	International Code for the Construction and Equipment of Ships Carrying Liquefied Gases in Bulk (IMO)
<b>IGF</b>	International Code of Safety for Ships Using Gases or other Low-Flashpoint Fuels (IMO)
<b>IMO</b>	International Maritime Organization
<b>IPCC</b>	Intergovernmental Panel on Climate Change
<b>IRENA</b>	International Renewable Energy Agency
<b>ISO</b>	International Organization for Standardization
<b>LFO</b>	Light Fuel Oil
<b>LFL</b>	Lower Flammability Limit
<b>IGF</b>	International Code of Safety for Ships Using Gases or other Low-Flashpoint Fuels (IMO)
<b>IMO</b>	International Maritime Organization
<b>IPCC</b>	Intergovernmental Panel on Climate Change
<b>IRENA</b>	International Renewable Energy Agency
<b>ISO</b>	International Organization for Standardization

<b>LFO</b>	Light Fuel Oil
<b>LFL</b>	Lower Flammability Limit
<b>LH2</b>	Liquid Hydrogen
<b>LL</b>	Loading Limit
<b>LNG</b>	Liquified Natural Gas
<b>LNGC</b>	Liquified Natural Gas Carrier
<b>LP</b>	Low Pressure
<b>LPG</b>	Liquified Petroleum Gas
<b>MAN ES</b>	MAN Energy Solutions
<b>MARPOL</b>	Marine Pollution (IMO)
<b>MCFC</b>	Molten Carbonate Fuel Cell
<b>MCR</b>	Maximum Continuous Rating
<b>MDO</b>	Marine Diesel Oil
<b>ME-GI</b>	MAN engine identifier – M series Electronic Gas Injection
<b>ME-LGI</b>	MAN engine identifier – M series Electronic Liquid Gas Injection
<b>ME-LGIA</b>	MAN engine identifier – M series Electronic Liquid Gas Injection Ammonia
<b>ME-LGIM</b>	MAN engine identifier – M series Electronic Liquid Gas Injection Methanol
<b>ME-LGIP</b>	MAN engine identifier – M series Electronic Liquid Gas Injection LPG
<b>MEPC</b>	Marine Environment Protection Committee (IMO)
<b>MIE</b>	Minimum Ignition Energy
<b>MGO</b>	Marine Gas Oil
<b>MRV</b>	Monitoring Reporting Verification (EU)
<b>MSC</b>	Maritime Safety Committee (IMO)
<b>MSDS</b>	Material Safety Data Sheet
<b>NACE</b>	National Association of Corrosion Engineers
<b>NGO</b>	Non-Governmental Organisation
<b>NH3</b>	Ammonia
<b>NO</b>	Nitrogen Oxide
<b>NO2</b>	Nitrogen Dioxide
<b>NOx</b>	Nitrogen Oxides
<b>N2O</b>	Nitrous Oxide
<b>NTC</b>	NOx Technical Code
<b>OECD</b>	Organization for Economic Co-operation and Development
<b>OEM</b>	Original Equipment Manufacturer
<b>OPEX</b>	Operating Expenditure
<b>PAH</b>	Polycyclic Aromatic Hydrocarbons
<b>PEM</b>	Proton Exchange Membrane
<b>PAFC</b>	Phosphoric Acid Fuel Cell
<b>PM</b>	Particulate Matter
<b>PPE</b>	Personal Protective Equipment
<b>PPM</b>	Parts Per Million
<b>PPR</b>	Pollution Prevention and Response Sub-Committee (IMO)
<b>PRV</b>	Pressure Relief Valve
<b>PSC</b>	Port State Control
<b>RA</b>	Risk Assessment
<b>RAM</b>	Reliability, Availability and Maintainability
<b>RED</b>	Renewable Energy Directive (EU)

<b>SCR</b>	Selective Catalytic Reduction
<b>SDS</b>	Safety Data Sheet
<b>NECA</b>	NOx Emission Control Area
<b>SFOC</b>	Specific Fuel Oil Consumption
<b>SGMF</b>	Society for Gas as a Marine Fuel
<b>SIGTTO</b>	Society of International Tanker and Terminal Operators
<b>SIMOPS</b>	Simultaneous Operations
<b>SMR</b>	Steam Methane Reforming
<b>SOFC</b>	Solid Oxide Fuel Cell
<b>SOLAS</b>	International Convention for the Safety of Life at Sea, 1974, as amended (IMO)
<b>SOEC</b>	Solid Oxide Electrolyser Cell
<b>SO2</b>	Sulphur Dioxide
<b>SOx</b>	Sulphur Oxides
<b>STCW</b>	Standards of Training, Certification and Watchkeeping for seafarers
<b>TCO</b>	Total Cost of Ownership
<b>TCD</b>	Thermo-Catalytic Decomposition
<b>TCS</b>	Tank Connection Space
<b>TEU</b>	Twenty Foot Equivalent (Container)
<b>THC</b>	Total Hydrocarbon
<b>ToR</b>	Terms of Reference
<b>TRL</b>	Technology Readiness Level
<b>TTW</b>	Tank To Wake
<b>UI</b>	Unified Interpretation
<b>UR</b>	Unified Requirement
<b>USCG</b>	United States Coast Guard
<b>VLCC</b>	Very Large Crude Carrier
<b>VLSFO</b>	Very Low Sulphur Fuel Oil
<b>VOC</b>	Volatile Organic Compound
<b>WinGD</b>	Winterthur Gas & Diesel

## Appendix II – Impact of H<sub>2</sub> Auxiliary Engines and Fuel Cells in CII

### 1. Effect of Hydrogen Fuelled Auxiliary Engine

The operational data presented in tables below have been assumed for a 23k Containership:

Table 37. Running Hours per annum

	Seagoing	Maneuvering	In Port
<b>Main Engine</b>	7,000	317	0
<b>Aux. Engine (/AE)</b>	7,000	317	1,440
<b>Boiler (/boiler)</b>	0	317	1,440

Table 38. Main Engine Operational Data

	Seagoing	Maneuvering	In Port
<b>No. Operating</b>	1	1	-
<b>Load (%)</b>	70.0%	30.0%	-
<b>Speed (knots)</b>	20.5	6	-
<b>Power (kW)</b>	64,650		-
<b>SFOC (g/kW)</b>	154.5	160.5	-
<b>Consumption tonnes/h</b>	7.0	3.1	-

Table 39. Auxiliary Engine Data\*\*

	Seagoing	Maneuvering	In Port
<b>No. Operating</b>	2	3	2
<b>Load (%)</b>	80.0%	80.0%	80.0%
<b>Power (kW)</b>	4,640		
<b>Actual Power</b>	7,424	11,136	7,424
<b>SFOC (g/kW)</b>	180.8	180.8	180.8
<b>Consumption tonnes/h</b>	1.3	2.0	1.3

\*\* 50% reefer load is assumed

Based on the above data, the CII can be estimated.

### CII Calculation for the conventional 23kTEU Container Vessel

The CII calculation is based on the annual AER value. This is the total CO<sub>2</sub> produced over the year (in grams) divided by the product of the vessel deadweight by the distance travelled. The DWT of the vessel is 221,770 tonnes.

Based on the operational data, the following annual fuel is calculated in table below:

Table 40. Consumption per year

	Seagoing	Maneuvering	In Port	TOTAL
<b>Main Engine</b>	48,943	987	0	49,930
<b>Aux. Engine (/AE)</b>	9,396	638	1,933	11,967
<b>Boiler (/boiler)*</b>	0	95.1	432	527
				62,424

\* boiler consumption per hour is assumed 0.3 tonnes/h.

The annual distance travelled is shown in table below:

Table 41. Distance Travelled nm

	Seagoing	Maneuvering	TOTAL
<b>Main Engine</b>	143,500	1,902	145,402

Three cases are considered for the fuel used during the year on the vessel, 100% HFO, 100% MGO and a combination (80% HFO, 20% MGO).

Table 42. Carbon Factors

HFO	MGO	Combination
3.114	3.206	3.132

Using all of the above results in the following uncorrected (no correction or voyage adjustments have been applied) AER values:

Table 43. AER uncorrected values

HFO	MGO	Combination
6.12	6.30	6.16
E	E	E

Based on the best case, which is 100% HFO, the rating for the vessel is shown in table below:

Table 44. Estimated CII Rating

HFO		2023	2024	2025	2026
Estimated CII	6.03	4.63	4.59	4.54	4.50
	CII Req Rating	E	E	E	E

As the vessel is a container vessel fitted with reefer containers, the AER can be corrected to disregard the consumption associated with the reefers. This can be corrected in one of two ways, depending on whether there is reefer consumption monitoring or not.

- Without Reefer Consumption Monitoring based on  $FC_{\text{electrical\_reefer},j}$  (formula as per MEPC.355(78)):

Table 45. Correction based on MEPC.335(78)

No. of Reefers	Cx	Days at sea	Days at port	Reefer_ Days <sub>sea</sub>	Reefer_ Days <sub>port</sub>	FC <sub>electrical_reefer,j</sub>
750	2.75	304.9	60.0	228,656	45,000	2,927.7

Table 46. AER Corrected values

AER - Corrected		
HFO	MGO	Combination
5.75	5.92	5.78
E	E	E

Table 47. Estimated CII Rating

HFO			2023	2024	2025	2026
Estimated CII	5.75	CII Req	4.63	4.59	4.54	4.50
		Rating	E	E	E	E

- With Reefer Consumption Monitoring:

Table 48. Consumption

Reefer Power	SFOC Used	Seagoing	Maneuvering	In Port	TOTAL
3,750	180.8	4,746	215	976	5,937

Table 49. AER Corrected values

AER - Corrected		
HFO	MGO	Combination
5.45	5.62	5.49
D	E	D

Table 50. Estimated CII Rating

HFO			2023	2024	2025	2026
Estimated CII	5.45	CII Req	4.63	4.59	4.54	4.50
		Rating	D	E	E	E

### CII Calculation for the 23kTEU Container Vessel with 1 Hydrogen fuelled Auxiliary Engine

This section calculates the effect of replacing one of the conventional Auxiliary Engines by one fuelled by hydrogen. It is assumed that the electrical power for the refers is not provided by the hydrogen fuelled auxiliary engine.

This results in the numbers shown in table below:

Table 51. Auxiliary Engine's Operational Data with 1 H2 A/E\*\*

	Seagoing	Maneuvering	In Port
<b>No. Operating</b>	1	3	1
<b>Load (%)</b>	80.0%	80.0%	80.0%
<b>Power (kW)</b>	4,640		
<b>Actual Power</b>	3,712	7,424	3,712
<b>SFOC (g/kW)</b>	180.8	180.8	180.8
<b>Consumption tonnes/h</b>	0.7	1.3	0.7

\*\* 50% reefer load is assumed

The updated consumption is shown in table below:

Table 52. Consumption per year

Consumption per year				
	Seagoing	Maneuvering	In Port	TOTAL
<b>Main Engine</b>	48,943	987	0	49,930
<b>Aux. Engine (/AE)</b>	4,698	425	966	6,090
<b>Boiler (/boiler)*</b>	0	95.1	432	527
				56,547

\* boiler consumption is assumed 0.3 tonnes/h.

Other data remain unchanged and therefore the AER are shown in table below:

Table 53. AER Uncorrected data

HFO	MGO	Combination
5.46	5.62	5.49
D	E	E

Table 54. Estimated CII Rating

HFO		2023	2024	2025	2026
Estimated CII	5.46	CII Req 4.63	4.59	4.54	4.50
		Rating	D	E	E



As above, the AER can be corrected using the same two ways.

- Without Reefer Consumption Monitoring:

Table 55. AER Corrected data

HFO	MGO	Combination
5.18	5.33	5.21
D	D	D

Table 56. Estimated CII Rating

HFO		2023	2024	2025	2026	
Estimated CII	5.18	CII Req	4.63	4.59	4.54	4.50
		Rating	D	D	D	D

- With Reefer Consumption Monitoring:

Table 57. AER Corrected data

HFO	MGO	Combination
4.89	5.03	4.92
C	D	D

Table 58. Estimated CII Rating

HFO		2023	2024	2025	2026	
Estimated CII	4.89	CII Req	4.63	4.59	4.54	4.50
		Rating	C	C	D	D

## 2. Effect of Carbon Capture, Hydrogen Generating system and Fuel Cell Auxiliary

The operational data shown in tables below have been assumed for a 174k LNG Carrier:

Table 59. Operational data

			LADEN					
		Loading	8 knots	15 knots	7.5 knots	NECA at 18.5 knots	Misc at anchor	Passage at 18.5 knots
M/E	Number		2	2	2	2		2
	Power		2,644	5,320	2,644	9,903		9,903
	Hours	384	39	37	24	853	327	2,698
A/E*	Number	2	1	1	1	1	1	1
	Power	4,906	2,997	3,038	2,997	3,038	1,928	3,038
	Hours	384	39	37	24	853	327	2,698

		BALLAST						
		Discharge	8 knots	15 knots	7.5 knots	NECA at 18.5 knots	Misc at anchor	Passage at 18.5 knots
M/E	Number		2	2	2	2		2
	Power		2,542	5,127	2,542	9,573		9,573
	Hours	461	35	37	24	853	170	2,698
A/E*	Number	3	1	1	1	1	1	1
	Power	7,920	2,997	3,038	2,997	3,038	1928	3,038
	Hours	461	35	37	24	853	170	2,698

\* Without reliq use and load.

Table 60. Main Machinery Operational Data

	Main Engines	Auxiliary Engines
<b>Number</b>	2	4
<b>Power (kW)</b>	11,894	3,360

Table 61. Reliquefaction System consumption

Reliq Capacity	Consumption (tonnes/h)
0.3	0.080
0.6	0.118
1	0.163
1.5	0.245

Table 62. Boil Off Gas Amount

<b>Cargo tank capacity</b>		<b>174,000</b>	m <sup>3</sup>
<b>Boil off rate</b>	Laden	<b>0.085%</b>	per day (of cargo volume)
	Ballast	<b>0.038%</b>	per day of tank Volume (45% of fully laden)
<b>Spec. grav. LNG</b>		<b>0.45</b>	t/m <sup>3</sup>
<b>LNG max. filling (%)</b>		<b>98.5%</b>	
<b>BOG fuel equivalent</b>	Laden	<b>0.98</b>	kg MDO/kg fuel gas
	Ballast	<b>1.2</b>	kg MDO/kg fuel gas
<b>BOG</b>	Laden	<b>64.2</b>	t/day
	Ballast	<b>35.4</b>	t/day
			2.7 t/h
			1.5 t/h

Based on the above data, the CII can be estimated.

### CII Calculation for the conventional 174k LNG Carrier

The CII calculation is based on the annual AER value. This is the total CO<sub>2</sub> produced over the year (in grams) divided by the product of the vessel deadweight by the distance travelled. The DWT of the vessel is 92,000 tonnes.

Based on the operational data, the following annual fuel consumption and CO<sub>2</sub> emission are calculated:

Table 63. Annual totals (tonnes)

LNG	MGO	CO <sub>2</sub>
22,517	278	62,814

Based on the following carbon factors:

Table 64. Carbon factors

LNG	MGO
2.75	3.206

Combined with the annual distance travelled and deadweight:

Table 65. Operational data

		LADEN					
	Loading	8 knots	15 knots	7.5 knots	NECA at 18.5 knots	Misc at anchor	Passage at 18.5 knots
Hours	384	39	37	24	853	327	2,698
Speed knots	0.0	8.0	15.0	7.5	18.5	0.0	18.5
Distance nm	-	313	562	180	15,784	-	49,906
		BALLAST					
	Discharge	8 knots	15 knots	7.5 knots	NECA at 18.5 knots	Misc at anchor	Passage at 18.5 knots
Hours	461	35	37	24	853	170	2,698
Speed knots	0.0	8.0	15.0	7.5	18.5	0.0	18.5
Distance nm	-	280	562	180	15,784	-	49,913

Leading to the following AER and rating as shown in the below tables:

Table 66. AER

AER Calc		
CO <sub>2</sub> (g)	Dist	AER
62,814,380,150	Would it be possible to expand a bit more on this? Some visualization of what this actually is would benefit the reading	5.12

Table 67. Estimated CII Rating

Conventional		2023	2024	2025	2026	
Estimated CII	5.12	CII Req	7.50	7.43	7.35	7.28
		Rating	A	A	A	A

### CII Calculation for the conventional 174k LNG Carrier equipped with the Fuel Cell

This section considers a CCS which generates high purity hydrogen to power a fuel cell. The data is provided by Rotoboost. Namely, a BOG consumption providing a production of H<sub>2</sub>:

Table 68. CCS data

<b>BOG Cons (tonnes/h)</b>	4.693
<b>H<sub>2</sub> Generated (tonnes/h)</b>	0.714

Fuel cell power for a given amount of H<sub>2</sub> can be calculated, assuming that LCV of H<sub>2</sub> is 120,000 KJ/kg, fuel cell efficiency is 60% and the resulting power is 14,280 kW. This power level is larger than one of the Main Engines. However, this is the only available data. As fuel cells are most efficient when operating at a fixed high-power level, scaling down the size of the CCS and fuel cell is needed. Assuming that this reduction maintains the proportionality of the BOG consumption and H<sub>2</sub> generation, the sizing shown in table below can be used to replace one of the A/E by the fuel cell.

Table 69. Fuel Cell and CCS sizing

Resizing the Fuel Cell and CCS	
Required Power (kW)	3,000
Hydrogen (kg/h)	150.0
Assuming proportionality	
BOG Cons tonnes/h	0.99

As this 0.99 tonnes/h consumption does not generate CO<sub>2</sub>, and is sufficient to cover the needs of 1 A/E at sea (and 1 of the 2 during loading and 1 of the 3 during discharge), the annual consumption, CO<sub>2</sub> generation and AER are obtained as shown in tables below:

Table 70. Annual Totals

Machinery		
LNG	MGO	CO <sub>2</sub>
18,815	210	52,414
Fuel Cell		
LNG	MGO	CO <sub>2</sub>
8,520	0	-

Table 71. AER

AER Calc		
CO <sub>2</sub> (g)	Dist	AER
52,413,531,858	133,463	4.27

Table 72. Estimated CII Rating

CCS + Fuel Cell			2023	2024	2025	2026
Estimated CII	4.27	CII Req	7.50	7.43	7.35	7.28
		Rating	A	A	A	A

## Appendix III – Hydrogen Safety Data Sheet (SDS)



Linde CH2 SDS.pdf

## Appendix IV – Pilots and other Projects with Hydrogen-Fuelled Ships

Table 73. Pilots and other projects

Company / project	Propulsion system	Type of Ship	Type of Project	Start year	Remarks
Switch Maritime ( <i>Sea Change</i> )	Fuel Cell	Small passenger ferry	Finished	2016	Ferry Service in San Francisco Bay
Energy Observer	Fuel Cell & Sails	Catamaran	Demonstration	2017	Generating hydrogen onboard from renewable sources. World tour to demonstrate technology and raise awareness for decarbonised shipping.
Hydroville (CMB Tech)	Internal Combustion Engine (DF)	Small passenger vessel	Finished	2017	Passenger ferry, exhibition and testing vessel, fitted with ABC Engines BeHydro DF
ABC Engines (CMB Tech) BeHydro	Internal Combustion Engine	Vessels in General	Announced	2020	DF Engines available (85% H <sub>2</sub> ), Monofuel H <sub>2</sub> engines announced
HydroBingo (CMB Tech)	Internal Combustion Engine (DF)	Ferry	Finished	2021	
FPS Maas (FutureProofShipping)	Fuel Cell	Inland Container Vessel	Under Development	2021	Retrofit river cargo vessel with hydrogen fuel cells
MF Hydra (Norway) Elizabeth Queen Swann, 2021)	Fuel cell	Ferry	Finished	2021	
Hydrocat (CMB Tech)	Internal Combustion Engine (DF)	Wind Farm Personnel Transfer	Finished	2022	MAN D2862 LE448 DF Engines
Hydrotug (CMB Tech)	Internal Combustion Engine	Tugboat	Under Development	2022	
UC San Diego Scripps Institute (Glosten)	Fuel Cell	Coastal Research Vessel	Under Development	2022	Received \$35 million from California Legislators
Ulstein Cresswell, 2020) Ulstein, 2019)	Fuel cell	Offshore vessel	Under development	2022	
HySeas III Project Fahnestock & Bingham, Mapping of Zero Emission Pilots and Demonstration Projects, 2021) Hyseas III, sd)	Fuel cell	Sea-going ferry	Research program into the theory	2022	
FreeCO2AST Development project (Havyard) Fahnestock & Bingham, Mapping of Zero Emission Pilots and	Fuel cell	Large tourist ferry	Announced	2023	

Demonstration Projects, 2021)					
Vestland county municipality Green Shipping Programme, 2020)	Fuel cell	High-speed hydrogen-powered passenger vessels	Pilot Project	2023-2024	
Tata Steel, Van Dam Shipping Alles Over Waterstof, 2022)	Unknown	Short-sea vessel	Announced	2024	Right now, they are in the development stage.
Power2AX Project (Finland) Flexens, 2020) Fahnestock & Bingham, Mapping of Zero Emission Pilots and Demonstration Projects, 2021)	Fuel cell	Ferry	Feasibility study	2024	The project realisation could be expected at the earliest in the beginning of year 2024.
DFDS DFDS, 2020)	Fuel cell	Large ferry	Test phase	Unknown	
Project Seashuttle (Samskip) Prevljak, SeaShuttle hydrogen-fuelled containership project wins Enova funding, 2022)	Fuel cell	Container ship	Announced	Unknown	Just won 15 million EUR in funding from Enova.
Man Energy Solutions Man Energy Solutions)	Internal combustion engine	Vessels in general	Announced	Unknown	
J-ENG, Kawasaki Heavy Industries, Yanmar Power Technology Ship Technology, 2021)	Internal combustion engine	An in-service vessel (not specified)	Trial announced	Unknown	
HyMethShip Project Green Car Congress, 2022)	Internal combustion engine	Ferries, container ships and cruise ships	Concept	Unknown	The ship is refuelled with methanol at port. On board, hydrogen is obtained from the methanol through a steam reforming process and is used for ship propulsion.
Energy Observer Project (France) Prevljak, Energy Observer unveils zero-emission, LH2-powered cargo ship concept, 2022)	Fuel cell	Cargo ship	Announced	Unknown	



## Appendix V – Additional Details of the TCO Modelling for Hydrogen-Fuelled ships

In this appendix, input data and further details on TCO results in a high fuel price scenario are presented. First the details on CAPEX and OPEX data are outlined. Secondly, the results for the TCO for the case study vessels in the high fuel price scenario are presented.

### CAPEX data

Details on the capital expenditures are listed in the following tables. The engine cost for the reference and hydrogen dual fuel engines are indicated in Table 74. The cost data and cost reduction path for fuel cell systems are listed in Table 75. The propulsion system cost for the fuel cell system, which implies the application of an electrical engine are in Table 76. Details on the cost for the battery system which is applied to vessels using hydrogen propulsion are indicated in Table 77..

Table 74. Engine cost input

Ship category	Engine type	Suitable for fuel type	Ship size	Engine Cost per kW in EUR (2022)
Small coastal vessels	Two stroke CI low speed diesel internal combustion engine	Fossil fuel (VLSFO)	All vessel types* with size up to 15,000 dwt	€ 250
Large coastal vessels	Two stroke CI low speed diesel internal combustion engine	Fossil fuel (VLSFO)	All vessel types* with size above 15,000 dwt	€ 200
Coastal Containerships	Two stroke CI low speed diesel internal combustion engine	Fossil fuel (VLSFO)	All sizes containerships	€ 190
Small coastal vessels	Dual fuel two stroke CI internal combustion engine	Hydrogen + pilot fuel	All vessel types* with installed powered up to 2,500 kW	€ 850
Large coastal vessels	Dual fuel two stroke CI internal combustion engine	Hydrogen + pilot fuel	All vessel types* with installed powered more than 2,500 kW	€ 560

\* Excluding containerships

Table 75. Fuel cell system cost development assumptions

Parameter	2022	2030	2040	2050	2060
Cost decrease per 10 year (assumed based on literature)	-	30.0%	7.0%	5.0%	2.5%
Fuel cell system (EUR/kW)	€ 1,310	€ 920	€ 850	€ 810	€ 790

Table 76. Propulsion system cost

Ship category	System item	Ship type and size	EUR per kW (2020)
Small coastal vessels	Electric motor	All vessel types* with size up to 15,000 dwt	€ 180
Large coastal vessels	Electric motor	All vessel types* with size above 15,000 dwt	€ 140
Coastal Containerships	Electric motor	All sizes containerships	€ 130
All coastal vessels	Gearbox	All vessel types	€ 70

Table 77. Battery pack cost development assumptions

Parameter	2022	2030	2040	2050
Battery system per MW excl pack (EUR)	€ 175,100	€ 96,300	€ 85,800	€ 75,300
Battery pack cost per MW (EUR)	€ 87,600	€ 48,200	€ 43,300	€ 37,600
Cost index compared to 2022 cost	-	55.0%	49.5%	43.0%

## OPEX data

### Fuel cost

The cost input for VLSFO cost is based on the EU ETS proposal (EC, 2021d; EC, 2021e) and spot market bunker prices Shipandbunker, 2022), Table 78. The cost input for green and blue hydrogen is based on based on the Fourth IMO GHG study and the HyChain model (IMO, 2020; ISPT, 2019). Green ammonia production cost is the average of the production cost of green ammonia in Australia, Chile, Morocco and Spain. See Figure 37 for the production cost of green hydrogen in the prominent hydrogen production countries. Note that the production concerns the production of green ammonia in the indicated countries, shipping to the EU and conversion to liquefied hydrogen including terminal storage cost.

Table 78. Fuel cost ranges for reference fuel and hydrogen variants in the years 2022, 2030 and 2050 per tonne of fuel

Fuel type	2022	2030 Min	2030 Max	2050 Min	2050 Max
VLSFO	€ 740	€ 447	€ 639	€ 735	€ 840
Biodiesel (pilot fuel)	€ 774	€ 770	€ 1,182	€ 832	€ 1,269
Green hydrogen	€ 7,893	€ 6,085	€ 6,864	€ 4,990	€ 6,102
Blue hydrogen	€ 6,086	€ 3,607	€ 4,264	€ 4,229	€ 4,859

The fuel cost projection shows the lowest cost for green hydrogen from ammonia production in Morocco. If green hydrogen is sourced from Morocco, the yearly TCO may be 3-5% lower than the average green hydrogen price as outlined in the analysis in the main body of the study. However, the case in which an average global market price for green hydrogen exists is considered in the main analysis, as it is unlikely one country can meet the demand for green hydrogen.

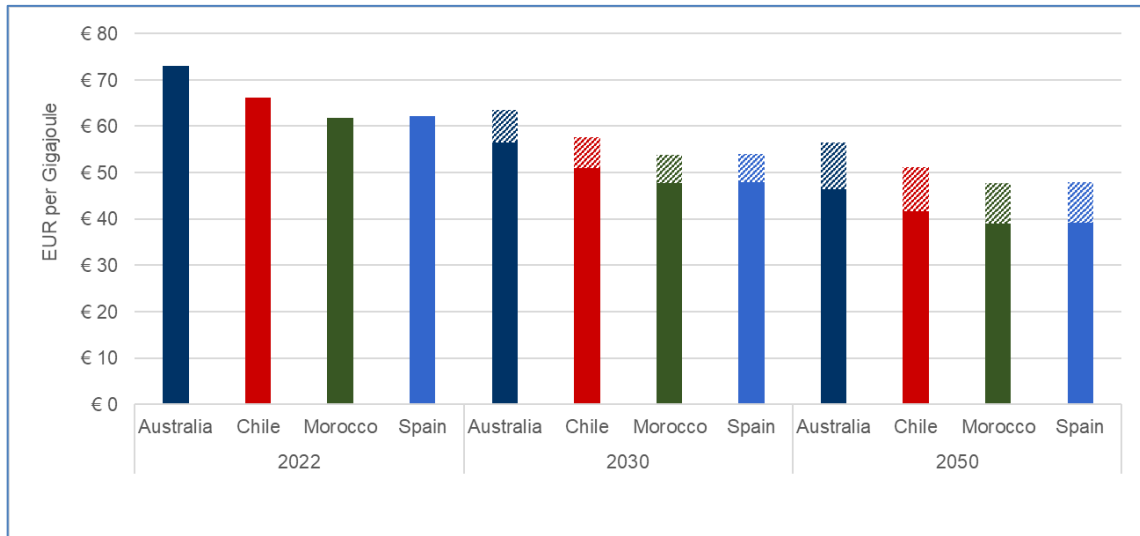

Figure 37. Overview of the production cost of liquefied hydrogen in several production countries

### Carbon cost (ETS)

The carbon cost for maritime (fossil) fuels as stated in (EC, 2021a) are listed in the first row of Table 79 and as also presented in terms of costs per tonne VLSFO.

Table 79. Carbon cost per tCO<sub>2</sub> and tonne VLSFO

	Unit	2020	2030	2050
ETS carbon price	EUR/tCO <sub>2</sub>	€ 0	€ 46	€ 150
Carbon content VLSFO	kgCO <sub>2</sub> /kg	3.21		
Carbon cost per tonne VLSFO	EUR/tonne	€ 0	€ 148	€ 480

### TCO results - high fuel price scenario

In this subsection the TCO results for the reference vessels for the high fuel production price scenario are presented, assuming newly built vessels. The results should serve as an indication of the cost range of the application of hydrogen in vessels. In Figure 38 and Figure 39 the costs for the ferry Ro-Pax and for Ro-Ro vessel are presented, assuming high fuel cost.

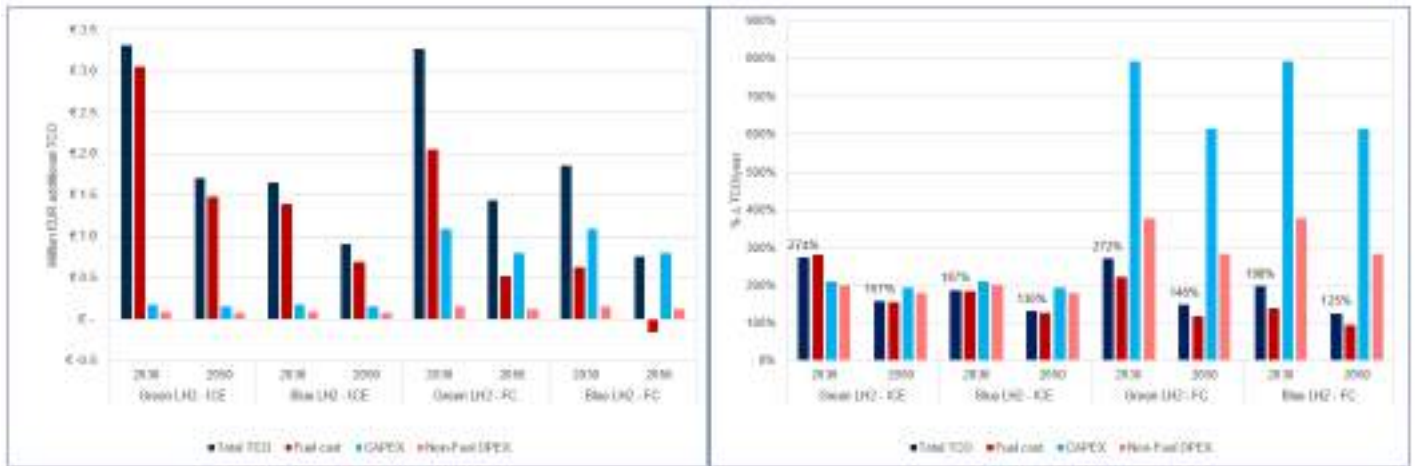

Figure 38. TCO estimation of Ferry Ro-Pax (2000-4999 dwt) in the high fuel price scenario

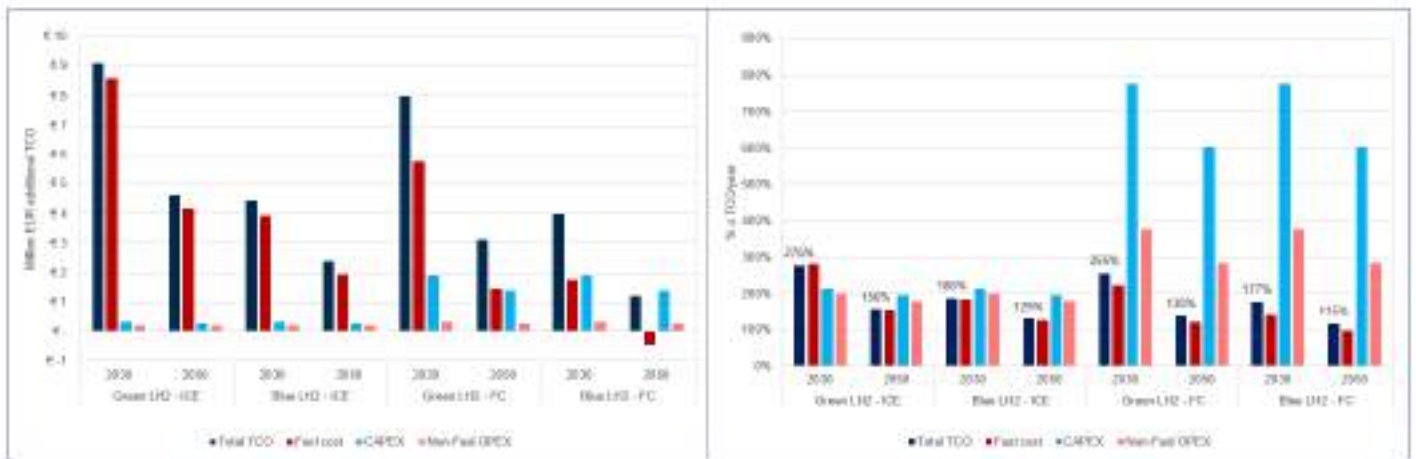

Figure 39. TCO estimation of Ro-Ro vessel (5000-9999 dwt) in the high fuel price scenario

The TCO for the reference vessels under high fuel prices are presenting similar cost ranges. Both the reference fuel VLSFO and the hydrogen ‘variants’ are higher in cost, while maintaining a similar ratio of the (maximum estimated) cost gap. Depending on the development of either of the fuels, the cost gap may be smaller.

The use of green hydrogen with internal combustion engine propulsion in the reference vessels results in a substantially higher TCO; about 275% higher in 2030 and about 155% higher in 2050 compared to the reference vessel powered by VLSFO. The TCO results for hydrogen used in a fuel cell system and electrical propulsion show higher cost figures. This is due to the higher CAPEX for the fuel cell stack, and battery system for electric propulsion. The cost for blue hydrogen use in fuel cells in 2030 under the high fuel prices is approximately 180-200% higher than for the reference case. In 2050 the cost is due to cost reductions of hydrogen propulsion system items decreased to about approximately 115-130% higher compared to the reference.

## Appendix VI – H<sub>2</sub> Classification per GHS and ECHA

- Link to European Chemicals Agency (ECHA) for Hydrogen - [Substance Information - ECHA \(europa.eu\)](https://echa.europa.eu)

EC / List no.: 215-605-7

CAS no.: 1333-74-0

Mol.formula: H<sub>2</sub>

- **Link:** Link for GHS Classification [GHS Classification \(nih.gov\)](https://www.nlm.nih.gov/chemview.htm?cid=C133374)

Globally Harmonised System (GHS) of Classification and Labelling of Chemicals for Compressed Hydrogen:

**Signal:** Danger

**GHS Hazard Statements**



Flammable

Compressed gas

H220: Extremely flammable gas [Danger Flammable gases]

### Precautionary Statement Codes

P210: Keep away from heat, hot surface, sparks, open flames and other ignition sources. No smoking.

P222: Do not allow contact with air.

P230: Keep wetted with ...

P280: Wear protective gloves/protective clothing/eye protection/face protection/hearing protection/...

### Response Precautionary Statement

P377: Leaking gas fire: Do not extinguish, unless leak can be stopped safely.

P381: In case of leakage, eliminate all ignition sources.

### Storage Precautionary Statement

P403: Store in a well-ventilated place.

(The corresponding statement to each P-code can be found at the GHS Classification page)

## Appendix VII – HAZID Risk Matrix

Category	Consequence Severity				
<b>Asset</b>	No shutdown, costs less than \$10,000 to repair	No shutdown, costs less than \$100,000 to repair	Operations shutdown, loss of day rate for 1-7 days and/or repair costs of up to \$1,000,000	Operations shutdown, loss of day rate for 7-28 days and/or repair costs of up to \$10,000,000	Operations shutdown, loss of day rate for more than 28 days and/or repair more than \$10,000,000
<b>Environmental Effects</b>	No lasting effect. Low level impacts on biological or physical environment. Limited damage to minimal area of low significance.	Minor effects on biological or physical environment. Minor short-term damage to small area of limited significance.	Moderate effects on biological or physical environment but not affecting ecosystem function. Moderate short-medium term widespread impacts e.g., oil spill causing impacts on shoreline.	Serious environmental effects with some impairment of ecosystem function e.g., displacement of species. Relatively widespread medium-long term impacts.	Very serious effects with impairment of ecosystem function. Long term widespread effects on significant environment e.g., unique habitat, national park.
<b>Community/ Government/ Media/ Reputation</b>	Public concern restricted to local complaints. Ongoing scrutiny/ attention from regulator.	Minor, adverse local public or media attention and complaints. Significant hardship from regulator. Reputation is adversely affected with a small number of site focused people.	Attention from media and/or heightened concern by local community. Criticism by NGOs. Significant difficulties in gaining approvals. Environmental credentials moderately affected.	Significant adverse national media/public/ NGO attention. May lose license to operate or not gain approval. Environment/ management credentials are significantly tarnished.	Serious public or media outcry (international coverage). Damaging NGO campaign. License to operate threatened. Reputation severely tarnished. Share price may be affected.
<b>Injury and Disease</b>	Low level short-term subjective inconvenience or	Objective but reversible disability/impairment and/or medical treatment, injuries	Moderate irreversible disability or impairment (<30%) to	Single fatality and/or severe irreversible disability or impairment	Short- or long-term health effects leading to

		symptoms. No measurable physical effects. No medical treatment required.	requiring hospitalisation.	one or more persons.	(>30%) to one or more persons.	multiple fatalities, or significant irreversible health effects to >50 persons.	
		<b>Low</b>	<b>Minor</b>	<b>Moderate</b>	<b>Major</b>	<b>Critical</b>	
		<b>1</b>	<b>2</b>	<b>3</b>	<b>4</b>	<b>5</b>	
<b>Likelihood</b>	<b>Almost Certain - Occurs 1 or more times a year</b>	<b>E</b>	<b>High</b>	<b>High</b>	<b>Extreme</b>	<b>Extreme</b>	<b>Extreme</b>
	<b>Likely - Occurs once every 1-10 years</b>	<b>D</b>	<b>Moderate</b>	<b>High</b>	<b>High</b>	<b>Extreme</b>	<b>Extreme</b>
	<b>Possible - Occurs once every 10-100 years</b>	<b>C</b>	<b>Low</b>	<b>Moderate</b>	<b>High</b>	<b>Extreme</b>	<b>Extreme</b>
	<b>Unlikely - Occurs once every 100-1,000 years</b>	<b>B</b>	<b>Low</b>	<b>Low</b>	<b>Moderate</b>	<b>High</b>	<b>Extreme</b>
	<b>Rare - Occurs once every 1,000-10,000 years</b>	<b>A</b>	<b>Low</b>	<b>Low</b>	<b>Moderate</b>	<b>High</b>	<b>High</b>
<b>Action Key</b>	<b>Low</b>	No action is required, unless change in circumstances					
	<b>Moderate</b>	No additional controls are required, monitoring is required to ensure no changes in circumstances					
	<b>High</b>	Risk is high and additional control is required to manage risk					
	<b>Extreme</b>	Intolerable risk, mitigation is required					

## Appendix VIII – List of Recommendations Ro-Pax

No.	Action	References
1	Conduct Fire Hazards Analysis, Gas Dispersion Analysis, Explosion Analysis to establish hazardous area zones and hazardous impact. Provide appropriate mitigations for fire and explosion consequences. Evaluate if the vessel structural damage due to explosion can compromise the damage stability and integrity of the vessel. Evaluate the vent mast design and hazardous area zone established by the vent mast.	1.1 Leakage upstream of ESDV-001 valve (i.e. flange connections, QCDC connections, hose) – Upper Bunkering Station 1.2 Leakage downstream of ESDV-001 valve – Upper Bunkering Station 1.7 H <sub>2</sub> leakage from bunker line when it is maintained at 20 bar nominal pressure – Upper Bunkering Station 2.4 Leakage upstream of ESDV-002 valve (i.e. flange connections, QCDC connections, hose) in Lower Bunker Station – Lower Bunker Station 2.5 Leakage downstream of ESDV-002 valve in Lower Bunker Station – Lower Bunker Station 4.3 Fire from main deck (vehicle fire) – H <sub>2</sub> Storage System Location on Wheelhouse Deck (open) (Tanks, Tank Interface, Supports) 5.1 H <sub>2</sub> leakage upstream of ESDVs to H <sub>2</sub> storage tanks – H <sub>2</sub> Storage System Location Below Deck (Tanks, Tank Interface, Supports) 5.3 Fire from main deck (vehicle fire) – H <sub>2</sub> Storage System Location Below Deck (Tanks, Tank Interface, Supports) 5.15 H <sub>2</sub> Tank failure – H <sub>2</sub> Storage System Location Below Deck (Tanks, Tank Interface, Supports) 11.1 General Recommendations – Venting System & Vents 11.2 Air in vent mast – Venting System & Vents
2	Install permanent H <sub>2</sub> gas detectors around the lower bunkering station to provide alarms/shutdown in case of H <sub>2</sub> leak or fire.	2.4 Leakage upstream of ESDV-002 valve (i.e. flange connections, QCDC connections, hose) in Lower Bunker Station – Lower Bunker Station 2.5 Leakage downstream of ESDV-002 valve in Lower Bunker Station – Lower Bunker Station
3	Study the effectiveness of permanent H <sub>2</sub> gas detector in the upper bunker station and as well as tank connection, manifolds and piping arrangement since the space is open.	1.1 Leakage upstream of ESDV-001 valve (i.e. flange connections, QCDC connections, hose) – Upper Bunkering Station 1.2 Leakage downstream of ESDV-001 valve – Upper Bunkering Station 1.3 High temperature in bunker line – Upper Bunkering Station 1.5 Blockage leading to bunker line overpressurisation – Upper Bunkering Station
4	Electrical groundings are to be provided for both shore and ship bunkering.	1.1 Leakage upstream of ESDV-001 valve (i.e. flange connections, QCDC connections, hose) – Upper Bunkering Station 2.4 Leakage upstream of ESDV-002 valve (i.e. flange connections, QCDC connections, hose) in Lower Bunker Station – Lower Bunker Station 9.1 General Recommendations – Electrical Systems
5	Develop bunkering procedures including the bunkering pressure and temperature in the H <sub>2</sub> storage tank to stay within tank design limits. Also, develop bunkering restrictions to avoid bunkering during adverse weather (rain, lightning, etc.) which can lead to connections overload, gas leakage, etc.	1.2 Leakage downstream of ESDV-001 valve – Upper Bunkering Station 1.10 Adverse weather, Low lighting during bunkering – Upper Bunkering Station 2.5 Leakage downstream of ESDV-002 valve in Lower Bunker Station – Lower Bunker Station
6	Develop pressure and temperature management plan and bunkering checklists for H <sub>2</sub> bunkering system, H <sub>2</sub> piping, and H <sub>2</sub> storage system.	1.3 High temperature in bunker line – Upper Bunkering Station
7	Develop proper bunkering plan considering the H <sub>2</sub> storage tank charge pressure and settle pressure considering atmospheric condition and temperature.	1.11 High pressure – Upper Bunkering Station 4.7 High pressure in H <sub>2</sub> storage system – H <sub>2</sub> Storage System Location on Wheelhouse Deck (open) (Tanks, Tank Interface, Supports)



No.	Action	References
		4.8 High temperature in H <sub>2</sub> storage system – H <sub>2</sub> Storage System Location on Wheelhouse Deck (open) (Tanks, Tank Interface, Supports)
8	Conduct berthing analysis, evaluate additional protections, establish operational restrictions to minimise the impact of adverse vessel motions. Consider the maximum wave and motion that can be generated from passing vessels.	1.4 Vessel motion – Upper Bunkering Station
9	Evaluate hose design considering potential adverse vessel motion, impact on equipment, and mooring loads.	1.4 Vessel motion – Upper Bunkering Station
10	Per IGF Code, add automatic and manual isolation valves at the bunker manifold. Current design only shows one automatic shutdown valve.	1.1 Leakage upstream of ESDV-001 valve (i.e. flange connections, QCDC connections, hose) – Upper Bunkering Station 2.4 Leakage upstream of ESDV-002 valve (i.e. flange connections, QCDC connections, hose) in Lower Bunker Station – Lower Bunker Station
11	Conduct detailed HAZOP at later engineering phase when system details (C&E Chart, P&IDs) are available H <sub>2</sub> storage system, Fuel Cell, etc.	1.5 Blockage leading to bunker line overpressurisation – Upper Bunkering Station 1.7 H <sub>2</sub> leakage from bunker line when it is maintained at 20 bar nominal pressure – Upper Bunkering Station 1.8 Backflow of H <sub>2</sub> into N <sub>2</sub> line – Upper Bunkering Station 6.2 High pressure downstream of Pressure Reduction Station – H <sub>2</sub> Supply System & Piping 9.1 General Recommendations – Electrical Systems 13.1 General Recommendations – Safety System (ESD & Isolation, Pressure Relief, F&G Detection)
12	Consider adding HH pressure shutdown to pressure transmitter PIA-001 at upper bunker station downstream of ESDV-001. Evaluate the expected volume of H <sub>2</sub> (expected low) in the bunker line between ESDV-001 and DB-01, and ESDV-001 to ESD valves on H <sub>2</sub> storage tanks.	1.5 Blockage leading to bunker line overpressurisation – Upper Bunkering Station 1.7 H <sub>2</sub> leakage from bunker line when it is maintained at 20 bar nominal pressure – Upper Bunkering Station
13	Develop detailed gassing, degassing, and purging procedures and fuel management plan (per IGF code) for bunkering operations.	1.6 H <sub>2</sub> contamination in H <sub>2</sub> bunkering line (i.e. oxygen) – Upper Bunkering Station
14	Conduct detailed study on purging operations as the bunkering manifold is already pressurised and there is no N <sub>2</sub> connection after the ESDV-001 valve. The scenario discussed is if there is an inability to purge the bunker hose, there is potential for H <sub>2</sub> contamination with O <sub>2</sub> in the bunker line, leading to flammable mixture.	1.7 H <sub>2</sub> leakage from bunker line when it is maintained at 20 bar nominal pressure – Upper Bunkering Station
15	Consult with Fuel Cell manufacturer on the H <sub>2</sub> purity requirements, potential impact of H <sub>2</sub> contamination (with O <sub>2</sub> , CO, NH <sub>3</sub> , H <sub>2</sub> O), and ensure that H <sub>2</sub> storage & supply systems and downstream systems are delivering H <sub>2</sub> at design limits.	1.7 H <sub>2</sub> leakage from bunker line when it is maintained at 20 bar nominal pressure – Upper Bunkering Station
16	Consider adding an isolation valve, i.e., double block and bleed valve or non-return valve (NRV), to the N <sub>2</sub> connection line.	1.8 Backflow of H <sub>2</sub> into N <sub>2</sub> line – Upper Bunkering Station
17	Develop operational procedures to ensure no overhead lifting when Fuel Cell system is running with H <sub>2</sub> supply and have restrictions in place to prevent dropped object impact on H <sub>2</sub> storage system, H <sub>2</sub> piping and H <sub>2</sub> bunkering lines.	1.9 Dropped Objects on bunkering line during bunkering – Upper Bunkering Station 4.5 Dropped objects onto H <sub>2</sub> Storage area – H <sub>2</sub> Storage System Location on Wheelhouse Deck (open) (Tanks, Tank Interface, Supports) 6.4 H <sub>2</sub> piping outer wall damage – H <sub>2</sub> Supply System & Piping
18	Ensure that there is adequate lighting on the ferry and onshore and consider low lighting impacts in bunkering study and bunkering procedures. Lighting equipment are to be EX-rated based on hazardous area zone classification.	1.10 Adverse weather, Low lighting during bunkering – Upper Bunkering Station

No.	Action	References
19	Consider sloped ceilings in the design to minimise the potential for gas accumulation in case of H <sub>2</sub> leak inside the Lower Bunker Station. Also, examine any dead spaces for potential H <sub>2</sub> accumulation.	2.2 H <sub>2</sub> leakage inside Lower Bunker Station – Lower Bunker Station
20	Develop design details for the space above the Lower Bunker Station as details are not currently available during HAZID workshop. Reconsider the void space in the area or add additional gas detectors to detect potential H <sub>2</sub> accumulation.	2.2 H <sub>2</sub> leakage inside Lower Bunker Station – Lower Bunker Station
21	Consider designing the void space as gas tight space and inerted or designing the H <sub>2</sub> bunker piping as double walled piping at the Lower Bunkering Station.	2.2 H <sub>2</sub> leakage inside Lower Bunker Station – Lower Bunker Station
22	Develop detailed hazardous area drawing and provide air locks if required for the Lower Bunkering Station.	2.3 Entry to Lower Bunker Station – Lower Bunker Station
23	Consider adding double wall piping for the bunker line passing through void spaces at the Lower Bunker Station.	2.6 H <sub>2</sub> leakage inside void space where the bunker line is passing – Lower Bunker Station
24	Consider running the bunker line for Lower Bunkering Station so the line is not in the damage penetration zone established by regulations.	2.6 H <sub>2</sub> leakage inside void space where the bunker line is passing – Lower Bunker Station
25	Conduct operational HAZID when bunkering procedures when detail designs are available.	2.6 H <sub>2</sub> leakage inside void space where the bunker line is passing – Lower Bunker Station
26	Proper selection of thermal protections to be provided considering the sensitivity of H <sub>2</sub> storage tank due to thermal impact or jet fire impingement or alternate arrangement to avoid jet impingement.	4.1 H <sub>2</sub> leakage upstream of ESDVs to H <sub>2</sub> storage tanks – H <sub>2</sub> Storage System Location on Wheelhouse Deck (open) (Tanks, Tank Interface, Supports) 5.1 H <sub>2</sub> leakage upstream of ESDVs to H <sub>2</sub> storage tanks – H <sub>2</sub> Storage System Location Below Deck (Tanks, Tank Interface, Supports)
27	Consider the design and arrangements of H <sub>2</sub> storage tanks to avoid any jet fire impingement on the tank due to connection leakage.	4.1 H <sub>2</sub> leakage upstream of ESDVs to H <sub>2</sub> storage tanks – H <sub>2</sub> Storage System Location on Wheelhouse Deck (open) (Tanks, Tank Interface, Supports) 5.1 H <sub>2</sub> leakage upstream of ESDVs to H <sub>2</sub> storage tanks – H <sub>2</sub> Storage System Location Below Deck (Tanks, Tank Interface, Supports)
28	Evaluate the effectiveness of F&G Detection in the H <sub>2</sub> storage area when the location is open on the wheelhouse deck.	4.1 H <sub>2</sub> leakage upstream of ESDVs to H <sub>2</sub> storage tanks – H <sub>2</sub> Storage System Location on Wheelhouse Deck (open) (Tanks, Tank Interface, Supports) 4.2 H <sub>2</sub> leakage downstream of ESDVs to Pressure reduction valves – H <sub>2</sub> Storage System Location on Wheelhouse Deck (open) (Tanks, Tank Interface, Supports) 5.1 H <sub>2</sub> leakage upstream of ESDVs to H <sub>2</sub> storage tanks – H <sub>2</sub> Storage System Location Below Deck (Tanks, Tank Interface, Supports)
29	Study the leak detection mechanisms to provide early leakage detection in case of leaks from H <sub>2</sub> storage tanks.	4.1 H <sub>2</sub> leakage upstream of ESDVs to H <sub>2</sub> storage tanks – H <sub>2</sub> Storage System Location on Wheelhouse Deck (open) (Tanks, Tank Interface, Supports) 4.2 H <sub>2</sub> leakage downstream of ESDVs to Pressure reduction valves – H <sub>2</sub> Storage System Location on Wheelhouse Deck (open) (Tanks, Tank Interface, Supports) 5.1 H <sub>2</sub> leakage upstream of ESDVs to H <sub>2</sub> storage tanks – H <sub>2</sub> Storage System Location Below Deck (Tanks, Tank Interface, Supports)
30	Investigate mechanisms for H <sub>2</sub> storage tank monitoring system (i.e. volume %) and programmable control logic to provide early leak detection from a H <sub>2</sub> tank.	4.1 H <sub>2</sub> leakage upstream of ESDVs to H <sub>2</sub> storage tanks – H <sub>2</sub> Storage System Location on Wheelhouse Deck (open) (Tanks, Tank Interface, Supports) 4.2 H <sub>2</sub> leakage downstream of ESDVs to Pressure reduction valves – H <sub>2</sub> Storage System Location on Wheelhouse Deck (open) (Tanks, Tank Interface, Supports) 5.1 H <sub>2</sub> leakage upstream of ESDVs to H <sub>2</sub> storage tanks – H <sub>2</sub> Storage System Location Below Deck (Tanks, Tank Interface, Supports)

No.	Action	References
31	Develop firefighting philosophy including F&G detection, surface temperature detection, shutdown & blowdown initiation, and cooling of H <sub>2</sub> tanks in case of fire.	<p>4.1 H<sub>2</sub> leakage upstream of ESDVs to H<sub>2</sub> storage tanks – H<sub>2</sub> Storage System Location on Wheelhouse Deck (open) (Tanks, Tank Interface, Supports)</p> <p>4.2 H<sub>2</sub> leakage downstream of ESDVs to Pressure reduction valves – H<sub>2</sub> Storage System Location on Wheelhouse Deck (open) (Tanks, Tank Interface, Supports)</p> <p>5.1 H<sub>2</sub> leakage upstream of ESDVs to H<sub>2</sub> storage tanks – H<sub>2</sub> Storage System Location Below Deck (Tanks, Tank Interface, Supports)</p>
32	Evaluate the surface temperature detection philosophy and its interaction with other tank protection mechanisms in case of fire impacting the H <sub>2</sub> storage tank.	<p>4.1 H<sub>2</sub> leakage upstream of ESDVs to H<sub>2</sub> storage tanks – H<sub>2</sub> Storage System Location on Wheelhouse Deck (open) (Tanks, Tank Interface, Supports)</p> <p>5.1 H<sub>2</sub> leakage upstream of ESDVs to H<sub>2</sub> storage tanks – H<sub>2</sub> Storage System Location Below Deck (Tanks, Tank Interface, Supports)</p>
33	Investigate the effectiveness of the water spray system such as nozzle arrangement, coverage zone, etc. in case of H <sub>2</sub> storage tank fire. Consider the potential for the water spray system activation to compromise the effectiveness of the H <sub>2</sub> tank thermal protection (i.e., thermal pressure relief device (TPRD)).	<p>4.1 H<sub>2</sub> leakage upstream of ESDVs to H<sub>2</sub> storage tanks – H<sub>2</sub> Storage System Location on Wheelhouse Deck (open) (Tanks, Tank Interface, Supports)</p> <p>4.2 H<sub>2</sub> leakage downstream of ESDVs to Pressure reduction valves – H<sub>2</sub> Storage System Location on Wheelhouse Deck (open) (Tanks, Tank Interface, Supports)</p> <p>4.6 Weather impact – H<sub>2</sub> Storage System Location on Wheelhouse Deck (open) (Tanks, Tank Interface, Supports)</p> <p>5.1 H<sub>2</sub> leakage upstream of ESDVs to H<sub>2</sub> storage tanks – H<sub>2</sub> Storage System Location Below Deck (Tanks, Tank Interface, Supports)</p>
34	H <sub>2</sub> Storage Tanks are to be designed for operation in the marine environment (Compatibility of materials with salty air)	4.6 Weather impact – H <sub>2</sub> Storage System Location on Wheelhouse Deck (open) (Tanks, Tank Interface, Supports)
35	Conduct the study on the protective framework which is to protect the H <sub>2</sub> storage tank, H <sub>2</sub> manifold, and pipe work and determine the appropriate mesh size. There is a tradeoff in terms of the framework providing protection and allowing for gas dispersion in case of H <sub>2</sub> gas leaks. Considering the area of operation and expected weather events, i.e., hailstorm and ferry travel profile.	4.6 Weather impact – H <sub>2</sub> Storage System Location on Wheelhouse Deck (open) (Tanks, Tank Interface, Supports)
36	Study the potential for ice formation and the impact on system performance. Provide appropriate mitigations.	4.6 Weather impact – H <sub>2</sub> Storage System Location on Wheelhouse Deck (open) (Tanks, Tank Interface, Supports)
37	Determine the tank duty cycles (pressurisation & depressurisation) and ensure that tank design & testing program to consider tank duty cycles for approval.	4.6 Weather impact – H <sub>2</sub> Storage System Location on Wheelhouse Deck (open) (Tanks, Tank Interface, Supports)
38	Consult tank supplier with failure modes of the tank (FMECA study) including potential for H <sub>2</sub> storage tank liner collapse during tank blowdown, regular tank pressurisation/depressurisation cycles.	<p>4.9 H<sub>2</sub> storage tank depressurisation (tank liner collapse) – H<sub>2</sub> Storage System Location on Wheelhouse Deck (open) (Tanks, Tank Interface, Supports)</p> <p>5.6 H<sub>2</sub> storage tank depressurisation (tank liner collapse) – H<sub>2</sub> Storage System Location Below Deck (Tanks, Tank Interface, Supports)</p> <p>5.15 H<sub>2</sub> Tank failure – H<sub>2</sub> Storage System Location Below Deck (Tanks, Tank Interface, Supports)</p>
39	Develop operating plan/procedures to verify the H <sub>2</sub> storage tank liner integrity after completing pressurisation. consider keeping a record of tank blowdown events and tank pressurisation cycles.	<p>4.9 H<sub>2</sub> storage tank depressurisation (tank liner collapse) – H<sub>2</sub> Storage System Location on Wheelhouse Deck (open) (Tanks, Tank Interface, Supports)</p> <p>5.6 H<sub>2</sub> storage tank depressurisation (tank liner collapse) – H<sub>2</sub> Storage System Location Below Deck (Tanks, Tank Interface, Supports)</p>
40	In the case of H <sub>2</sub> Storage System location below deck (enclosed compartment), the atmosphere inside the small compartment, dry air or inerted, are to be determined and risk to be evaluated with selection.	<p>5.1 H<sub>2</sub> leakage upstream of ESDVs to H<sub>2</sub> storage tanks – H<sub>2</sub> Storage System Location Below Deck (Tanks, Tank Interface, Supports)</p> <p>5.2 H<sub>2</sub> leakage downstream of ESDVs to H<sub>2</sub> storage tanks – H<sub>2</sub> Storage System Location Below Deck (Tanks, Tank Interface, Supports)</p>

No.	Action	References
41	H <sub>2</sub> Storage Tank isolations are to be evaluated considering IGF code requirements. Currently, the tank isolation valves are manual valves (i.e. 21-DB-06 and 21-NE-01).	5.1 H <sub>2</sub> leakage upstream of ESDVs to H <sub>2</sub> storage tanks – H <sub>2</sub> Storage System Location Below Deck (Tanks, Tank Interface, Supports)
42	Provide adequate relief protections for the H <sub>2</sub> Storage Tank space in case of leakage from H <sub>2</sub> piping.	5.1 H <sub>2</sub> leakage upstream of ESDVs to H <sub>2</sub> storage tanks – H <sub>2</sub> Storage System Location Below Deck (Tanks, Tank Interface, Supports)
43	Consider providing pressure monitoring in the H <sub>2</sub> Storage compartment in case of H <sub>2</sub> leak from piping, connections which can lead to overpressurisation in the small compartment.	5.1 H <sub>2</sub> leakage upstream of ESDVs to H <sub>2</sub> storage tanks – H <sub>2</sub> Storage System Location Below Deck (Tanks, Tank Interface, Supports)
44	Provide temperature monitoring in the H <sub>2</sub> storage compartment to detect heat load and protect the H <sub>2</sub> storage tank.	5.1 H <sub>2</sub> leakage upstream of ESDVs to H <sub>2</sub> storage tanks – H <sub>2</sub> Storage System Location Below Deck (Tanks, Tank Interface, Supports)
45	Evaluate the appropriate H <sub>2</sub> detection technology since currently available H <sub>2</sub> detectors require atmospheric environment with O <sub>2</sub> and will not work in an inerted environment.	5.2 H <sub>2</sub> leakage downstream of ESDVs to H <sub>2</sub> storage tanks – H <sub>2</sub> Storage System Location Below Deck (Tanks, Tank Interface, Supports)
46	Evaluate the isolation and blowdown philosophies for H <sub>2</sub> Storage Tank, considering the tank location in enclosed compartment.	5.2 H <sub>2</sub> leakage downstream of ESDVs to H <sub>2</sub> storage tanks – H <sub>2</sub> Storage System Location Below Deck (Tanks, Tank Interface, Supports)
47	Confirm temperature limits with tank supplier for H <sub>2</sub> Storage Tank, considering higher and lower temperatures than design limits.	4.10 Low temperature in H <sub>2</sub> storage system – H <sub>2</sub> Storage System Location on Wheelhouse Deck (open) (Tanks, Tank Interface, Supports) 5.5 High temperature in H <sub>2</sub> storage system – H <sub>2</sub> Storage System Location Below Deck (Tanks, Tank Interface, Supports) 5.7 Low temperature in H <sub>2</sub> storage system – H <sub>2</sub> Storage System Location Below Deck (Tanks, Tank Interface, Supports)
48	Design tank support and foundation to consider buoyancy effects due to flooding of H <sub>2</sub> Storage compartment.	5.8 Flooding of H <sub>2</sub> Storage compartment – H <sub>2</sub> Storage System Location Below Deck (Tanks, Tank Interface, Supports)
49	For H <sub>2</sub> Storage System location Below Deck, evaluate the appropriate Ingress Protection (IP) rating for electrical equipment and whether it should be gas tight or watertight.	5.8 Flooding of H <sub>2</sub> Storage compartment – H <sub>2</sub> Storage System Location Below Deck (Tanks, Tank Interface, Supports)
50	Determine the minimum functionalities that should be available to make the cargo compartment safe considering the H <sub>2</sub> inventory in case of compartment flooding e.g., blowdown	5.8 Flooding of H <sub>2</sub> Storage compartment – H <sub>2</sub> Storage System Location Below Deck (Tanks, Tank Interface, Supports)
51	Study the potential for vessel grounding, allision incidents and the resulting damage to the ferry frame, H <sub>2</sub> tank support, equipment, and structural damage. There is also potential for H <sub>2</sub> tank movement and damage, so also consider the impact to tank blowdown mechanisms.	5.11 Vessel grounding, allision – H <sub>2</sub> Storage System Location Below Deck (Tanks, Tank Interface, Supports)
52	Develop the maintenance and inspection plan for the equipment inside the H <sub>2</sub> storage compartment during the life of the vessel. Also consider the replacement of H <sub>2</sub> storage tanks.	5.12 Maintenance/Inspection issues due to tight compartment – H <sub>2</sub> Storage System Location Below Deck (Tanks, Tank Interface, Supports)
53	In case of H <sub>2</sub> storage location below deck, study the bunker line routing and consider double wall designs.	5.13 Bunker lines - general recommendations – H <sub>2</sub> Storage System Location Below Deck (Tanks, Tank Interface, Supports)
54	Conduct further studies on the H <sub>2</sub> storage compartment below deck entry and provide entry from car deck (main deck) and provide appropriate protections for personnel entering the space for inspection or maintenance activities.	5.14 Egress Routes from space - general recommendations – H <sub>2</sub> Storage System Location Below Deck (Tanks, Tank Interface, Supports)
55	Consider in the design that this H <sub>2</sub> storage compartment below deck is to be gas tight.	5.14 Egress Routes from space - general recommendations – H <sub>2</sub> Storage System Location Below Deck (Tanks, Tank Interface, Supports)
56	Consider putting all connections and piping from H <sub>2</sub> storage compartment below deck into a Tank Connection Space (TCS). TCS ventilation and vent system are to be developed.	5.1 H <sub>2</sub> leakage upstream of ESDVs to H <sub>2</sub> storage tanks – H <sub>2</sub> Storage System Location Below Deck (Tanks, Tank Interface, Supports)
57	Consider providing a fuel isolation valve at the H <sub>2</sub> fuel inlet to each Fuel Cell Module per type approval requirements.	
58	Consider providing a fuel isolation valve at the H <sub>2</sub> fuel inlet to each Fuel Cell Module per type approval requirements.	6.1 General recommendations – H <sub>2</sub> Supply System & Piping

No.	Action	References
59	Develop the overall Cause & Effects charts and integrate the Cause & Effect charts from Fuel Cell system.	6.2 High pressure downstream of Pressure Reduction Station – H <sub>2</sub> Supply System & Piping
60	Verify the ferry operating conditions including H <sub>2</sub> storage temperatures in various weather conditions considering the atmospheric conditions. Consider conducting fluid study to verify that H <sub>2</sub> supply system can meet the design temperature range for Fuel Cell system.	6.2 High pressure downstream of Pressure Reduction Station – H <sub>2</sub> Supply System & Piping
61	Consider providing detection mechanisms to detect H <sub>2</sub> piping damage since the current N <sub>2</sub> supply system is not monitoring for small N <sub>2</sub> leaks which can migrate into H <sub>2</sub> inner piping space.	6.3 H <sub>2</sub> piping inner wall damage – H <sub>2</sub> Supply System & Piping 6.4 H <sub>2</sub> piping outer wall damage – H <sub>2</sub> Supply System & Piping
62	Consider hot testing as part of Fuel Cell System startup operating procedures since there is no means to detect leaks in the H <sub>2</sub> piping annulus and the annulus is inerted with N <sub>2</sub> . Hot testing is to detect inner piping leaks in the H <sub>2</sub> supply piping.	6.3 H <sub>2</sub> piping inner wall damage – H <sub>2</sub> Supply System & Piping
63	Develop protocol and quality control requirements to properly weld Stainless Steel (SS316) H <sub>2</sub> piping to prevent pitting corrossions due to marine environment. This is a known issue in SS piping.	6.3 H <sub>2</sub> piping inner wall damage – H <sub>2</sub> Supply System & Piping 6.4 H <sub>2</sub> piping outer wall damage – H <sub>2</sub> Supply System & Piping
64	Conduct further study to determine N <sub>2</sub> leakage from H <sub>2</sub> piping annulus to surrounding space due to outer wall piping damage or consider monitoring the N <sub>2</sub> supply flow rate to provide early detection of N <sub>2</sub> leakages.	6.4 H <sub>2</sub> piping outer wall damage – H <sub>2</sub> Supply System & Piping
65	Develop periodic inspections and test plans for the H <sub>2</sub> piping to detect inner wall and outer wall damage. Piping connections are to be checked periodically to identify potential leak points.	4.1 H <sub>2</sub> leakage upstream of ESDVs to H <sub>2</sub> storage tanks – H <sub>2</sub> Storage System Location on Wheelhouse Deck (open) (Tanks, Tank Interface, Supports) 6.4 H <sub>2</sub> piping outer wall damage – H <sub>2</sub> Supply System & Piping
66	Evaluate the Fuel Cell system separately in a risk assessment and consider the risks when integrating the system in the ferry design. For example, consider potential risks in cathode and anode outlets of Fuel Cell system.	6.5 Emergency Shutdown of H <sub>2</sub> supply to Fuel Cell system - general recommendations – H <sub>2</sub> Supply System & Piping 9.1 General Recommendations – Electrical Systems
67	Develop mechanisms to collect and dispose of produced deionised water from Fuel Cell system onboard the ferry.	6.5 Emergency Shutdown of H <sub>2</sub> supply to Fuel Cell system - general recommendations – H <sub>2</sub> Supply System & Piping
68	Fuel Cell system selection is design is still under development. When more details are available, consider conducting a integration risk assessment (i.e. HAZID) to integrate Fuel Cell system with the ferry design.	7.1 General recommendations – Fuel Cell System 9.1 General Recommendations – Electrical Systems
69	When there are two Fuel Cell rooms in the center of the ferry, exhaust and vent design is to be evaluated when more details are available.	7.1 General recommendations – Fuel Cell System
70	Once a Fuel Cell supplier is selected and design is confirmed, select the appropriate firefighting philosophy for the Fuel Cell room and provide appropriate firefighting mechanisms.	7.1 General recommendations – Fuel Cell System
71	Once a Fuel Cell supplier is selected and design is confirmed, confirm system type approval and hazardous area classification of the Fuel Cell Room with class, and relevant class rules, i.e., air locks for hazardous area entry or Fuel Cell Room exhaust design, to be provided.	7.1 General recommendations – Fuel Cell System
72	Once a Li-ion battery system design and supplier are selected, conduct an integration risk assessment (HAZID) to verify design details with ferry design.	8.1 General recommendations – Li-ion Battery System 9.1 General Recommendations – Electrical Systems
73	Once a Li-ion battery system design and supplier are selected, develop battery room ventilation design, battery cooling system (air or liquid cool), firefighting philosophy, Li-ion battery hazards (thermal runaway issues), charging and monitoring of the batteries, location of battery room vents.	8.1 General recommendations – Li-ion Battery System
74	Once a Li-ion battery system design and supplier are selected, confirm the hazardous area classification with class and system redundancies.	8.1 General recommendations – Li-ion Battery System

No.	Action	References
75	Develop procedures to conduct H <sub>2</sub> storage tank inspection, tank purging with N <sub>2</sub> , gassing and degassing sequences. Operation will be done at port (i.e., local maintenance shipyard) with crew restrictions, and planned detailed procedures, to ensure sufficient N <sub>2</sub> bottles are available. Develop the requirements and expected amount of N <sub>2</sub> supply at a detail design stage.	1.6 H <sub>2</sub> contamination in H <sub>2</sub> bunkering line (i.e. oxygen) – Upper Bunkering Station 4.11 H <sub>2</sub> Storage Tank gassing up, degassing, purging - general recommendations – H <sub>2</sub> Storage System Location on Wheelhouse Deck (open) (Tanks, Tank Interface, Supports)
76	Develop loading and unloading plan for N <sub>2</sub> bottles and ensure appropriate restrictions are in place. Since N <sub>2</sub> bottles will be periodically replaced for H <sub>2</sub> tank purging operations.	4.11 H <sub>2</sub> Storage Tank gassing up, degassing, purging - general recommendations – H <sub>2</sub> Storage System Location on Wheelhouse Deck (open) (Tanks, Tank Interface, Supports)
77	During bunkering and idle period, H <sub>2</sub> will be maintained in all H <sub>2</sub> lines up to the isolation valve to each Fuel Cell unit, so develop procedures to maintain H <sub>2</sub> in the lines and detail HAZOP to be conducted to understand the risks.	4.11 H <sub>2</sub> Storage Tank gassing up, degassing, purging - general recommendations – H <sub>2</sub> Storage System Location on Wheelhouse Deck (open) (Tanks, Tank Interface, Supports)
78	Develop details of the vent and venting system design at a later stage. Evaluate if the vent mast needs to be purged with N <sub>2</sub> and provide sufficient N <sub>2</sub> supply. Further risk assessment to be conducted on detailed vent mast design.	11.1 General Recommendations – Venting System & Vents 11.2 Air in vent mast – Venting System & Vents
79	Per IGF code, provide separation of the inlet and outlet of hazardous areas.	11.1 General Recommendations – Venting System & Vents
80	Consult with Fuel Cell and Battery system suppliers to develop the ventilation system details and ensure that system meets IGF code. Ventilation system air inlet and outlet are to comply with IGF code requirements.	10.1 General recommendations – Ventilation System (H <sub>2</sub> Storage, Fuel Cell Room, Battery Room)
81	When more details are available for the Cooling System, discuss any related hazards in a HAZOP at a later detail design stage.	12.1 General Recommendation – Cooling System
82	Conduct assessment on Emergency Escape, Evacuation, and Rescue (EER) provisions when more details are available considering potential hazards such as from H <sub>2</sub> storage tank, vehicle fire, smoke impacting escape routes. Verify that EER provisions satisfies SOLAS and applicable local regulations.	17.1 General Recommendations – Emergency Escape, Evacuation, and Rescue 17.2 Passenger escape from starboard to port side during emergency – Emergency Escape, Evacuation, and Rescue
83	Provide appropriate fire & gas detection system, Emergency Shutdown and Isolation philosophy, pressure relief are to be developed at a later design stage. Consult Fuel Cell and Battery suppliers.	13.1 General Recommendations – Safety System (ESD & Isolation, Pressure Relief, F&G Detection)
84	Provide proper detection for leakage (i.e., from pressure relief valve, blowdown valve) in the vent and vent mast system.	11.2 Air in vent mast – Venting System & Vents 11.3 Venting system leakages – Venting System & Vents
85	Due to a potential leakage from relief and blowdown valves, develop proper valve inspection and maintenance plan.	11.3 Venting system leakages – Venting System & Vents
86	Develop detailed test, inspection, and maintenance plan for the H <sub>2</sub> storage tank, H <sub>2</sub> piping according to local regulations, marine regulations, and class rules. Based on selected arrangements for H <sub>2</sub> storage and H <sub>2</sub> piping. Consult with Fuel Cell and Battery system supplier to develop maintenance & inspection plan for these systems.	16.1 General Recommendations – Testing, Maintenance, & Inspection
87	Develop emergency procedures in case of H <sub>2</sub> leakage during passenger and vehicle embarkation and de-embarkation.	15.1 H <sub>2</sub> leakage during embarkation & de-embarkation – Other Vessel Operations (SIMOPS, Hazards in Port)
88	Consider verifying the H <sub>2</sub> storage tank design standard, tank testing, and manufacturing plan from tank supplier to minimise manufacturing defects. Also evaluate the impact of tank rupture on ferry pilot house and structures and evaluating the effectiveness of tank protections.	4.12 H <sub>2</sub> Tank failure due to manufacturing defects – H <sub>2</sub> Storage System Location on Wheelhouse Deck (open) (Tanks, Tank Interface, Supports) 5.15 H <sub>2</sub> Tank failure – H <sub>2</sub> Storage System Location Below Deck (Tanks, Tank Interface, Supports)
89	Consider conducting a vibration study on the concept design to understand the impact of vibration issues on H <sub>2</sub> piping and connections which may lead to H <sub>2</sub> leakage hazards.	4.14 Vibration issues – H <sub>2</sub> Storage System Location on Wheelhouse Deck (open) (Tanks, Tank Interface, Supports) 5.17 Vibration issues – H <sub>2</sub> Storage System Location Below Deck (Tanks, Tank Interface, Supports)
90	Discuss H <sub>2</sub> system threaded connections acceptance with class and regulators.	4.14 Vibration issues – H <sub>2</sub> Storage System Location on Wheelhouse Deck (open) (Tanks, Tank Interface, Supports) 5.17 Vibration issues – H <sub>2</sub> Storage System Location Below Deck (Tanks, Tank Interface, Supports)

No.	Action	References
91	Evaluate the blast wall design considering the potential H <sub>2</sub> tank rupture scenario. If appropriately designed, this can be a safeguard for H <sub>2</sub> Tank rupture scenario.	4.12 H <sub>2</sub> Tank failure due to manufacturing defects – H <sub>2</sub> Storage System Location on Wheelhouse Deck (open) (Tanks, Tank Interface, Supports) 5.15 H <sub>2</sub> Tank failure – H <sub>2</sub> Storage System Location Below Deck (Tanks, Tank Interface, Supports)
92	Conduct simulation and testing on the Battery system to ensure there is enough battery power available for various ferry operating modes.	8.1 General recommendations – Li-ion Battery System
93	Consider emergency power arrangement for the ferry operations and comply with class rules.	8.1 General recommendations – Li-ion Battery System
94	After connections bunker lines pressure testing proper tightness/leak testing to be performed. e.g., with helium or 5% H <sub>2</sub> /N <sub>2</sub>	1.1 Leakage upstream of ESDV-001 valve (i.e. flange connections, QCDC connections, hose) – Upper Bunkering Station 1.2 Leakage downstream of ESDV-001 valve – Upper Bunkering Station 2.5 Leakage downstream of ESDV-002 valve in Lower Bunker Station – Lower Bunker Station
95	Proper hose support are to be provided to prevent hose damage, hitting to hull and chaffing.	1.4 Vessel motion – Upper Bunkering Station
96	Consider working with port authority to develop safe zone and passing traffic speed restriction	1.4 Vessel motion – Upper Bunkering Station
97	Venting philosophy for trapped inventory to be developed after ESD or small leakage in piping, manifold etc.	11.1 General Recommendations – Venting System & Vents
98	Pressure relief system High pressure / Low pressure are to be separated to avoid any back pressure/reverse flow issue.	11.1 General Recommendations – Venting System & Vents
99	Relief vent lined are to design to avoid any air ingress to avoid any explosion in relief lines	11.1 General Recommendations – Venting System & Vents
100	Develop detail operational procedure and training	1.5 Blockage leading to bunker line overpressurisation – Upper Bunkering Station
101	Add connection for O <sub>2</sub> /N <sub>2</sub> concentration monitoring during purging	1.6 H <sub>2</sub> contamination in H <sub>2</sub> bunkering line (i.e. oxygen) – Upper Bunkering Station
102	Consider developing an action plan for detection of leak in bunker manifold during various stage of operation when bunkering is not done and mitigating action. Consider blowdown and purge to gain control on situation.	1.7 H <sub>2</sub> leakage from bunker line when it is maintained at 20 bar nominal pressure – Upper Bunkering Station
103	Detail procedure to be developed for N <sub>2</sub> use/purging etc. as there can be high risk of H <sub>2</sub> back flow into N <sub>2</sub> stream.	1.8 Backflow of H <sub>2</sub> into N <sub>2</sub> line – Upper Bunkering Station
104	Consider lighting study considering nigh operation and human.	1.10 Adverse weather, Low lighting during bunkering – Upper Bunkering Station
105	Fuel management details and procedure are to be developed per IGF code	1.11 High pressure – Upper Bunkering Station 4.7 High pressure in H <sub>2</sub> storage system – H <sub>2</sub> Storage System Location on Wheelhouse Deck (open) (Tanks, Tank Interface, Supports)
106	Conduct Fire Hazards Analysis, Gas Dispersion Analysis, Explosion Analysis to establish hazardous area zones and hazardous impact. Provide appropriate mitigations for fire and explosion consequences. Evaluate if the vessel structural damage due to explosion can compromise the damage stability and integrity of the vessel. Evaluate the vent mast design and hazardous area zone established by the vent mast.	2.2 H <sub>2</sub> leakage inside Lower Bunker Station – Lower Bunker Station 5.1 H <sub>2</sub> leakage upstream of ESDVs to H <sub>2</sub> storage tanks – H <sub>2</sub> Storage System Location Below Deck (Tanks, Tank Interface, Supports)
107	Develop procedure and training for entry to lower bunker area	2.3 Entry to Lower Bunker Station – Lower Bunker Station
108	Proper study to be conducted for fume management and further risk evaluated e.g., using single tank, group of tank or all the tank same time loading/usage etc.	4.1 H <sub>2</sub> leakage upstream of ESDVs to H <sub>2</sub> storage tanks – H <sub>2</sub> Storage System Location on Wheelhouse Deck (open) (Tanks, Tank Interface, Supports)

No.	Action	References
109	Consider tank support and deck structure to withstand blast load. Calculation to be done for fire and blast load.	4.1 H <sub>2</sub> leakage upstream of ESDVs to H <sub>2</sub> storage tanks – H <sub>2</sub> Storage System Location on Wheelhouse Deck (open) (Tanks, Tank Interface, Supports)
110	Investigate rain impact on effectiveness/performance of TPRD	4.6 Weather impact – H <sub>2</sub> Storage System Location on Wheelhouse Deck (open) (Tanks, Tank Interface, Supports)
111	CCPV tank detail FMECA are to be performed	4.9 H <sub>2</sub> storage tank depressurisation (tank liner collapse) – H <sub>2</sub> Storage System Location on Wheelhouse Deck (open) (Tanks, Tank Interface, Supports) 5.15 H <sub>2</sub> Tank failure – H <sub>2</sub> Storage System Location Below Deck (Tanks, Tank Interface, Supports)
112	After blowdown or extreme low-pressure event develop procedure to do leak test and verify integrity of liner before tank can be used or put in service	4.9 H <sub>2</sub> storage tank depressurisation (tank liner collapse) – H <sub>2</sub> Storage System Location on Wheelhouse Deck (open) (Tanks, Tank Interface, Supports)
113	N <sub>2</sub> quality requirement to be established in particular O <sub>2</sub> content to be max 1%.	4.11 H <sub>2</sub> Storage Tank gassing up, degassing, purging - general recommendations – H <sub>2</sub> Storage System Location on Wheelhouse Deck (open) (Tanks, Tank Interface, Supports)
114	Evaluate effectiveness of F&G detection in the H <sub>2</sub> storage area (closed/congested/below deck)	5.1 H <sub>2</sub> leakage upstream of ESDVs to H <sub>2</sub> storage tanks – H <sub>2</sub> Storage System Location Below Deck (Tanks, Tank Interface, Supports)
115	Deflagration/detonation protection to be consider for space	5.1 H <sub>2</sub> leakage upstream of ESDVs to H <sub>2</sub> storage tanks – H <sub>2</sub> Storage System Location Below Deck (Tanks, Tank Interface, Supports)
116	Consider all piping in tank connection space (TCS). TCS ventilation and vent mast to be developed.	5.2 H <sub>2</sub> leakage downstream of ESDVs to H <sub>2</sub> storage tanks – H <sub>2</sub> Storage System Location Below Deck (Tanks, Tank Interface, Supports)
117	Damage and stability criteria to be determine considering tank damage protection	5.8 Flooding of H <sub>2</sub> Storage compartment – H <sub>2</sub> Storage System Location Below Deck (Tanks, Tank Interface, Supports)
118	Emergency procedure are to be developed	5.8 Flooding of H <sub>2</sub> Storage compartment – H <sub>2</sub> Storage System Location Below Deck (Tanks, Tank Interface, Supports)
119	Consider all piping to meet leak-before-fail criteria	5.17 Vibration issues – H <sub>2</sub> Storage System Location Below Deck (Tanks, Tank Interface, Supports)
120	Consider vent mast design to withstand internal deflagration/detonation, and to be welded construction	11.2 Air in vent mast – Venting System & Vents
121	Bunker hose needs to go through New Technology qualification program as size and length need may not be available	18.1 Hose – Terminal Bunker delivery
122	Exclusion zone and safety zone are to be established by fire dispersion analysis with terminal and ship	18.1 Hose – Terminal Bunker delivery 18.2 Compressor – Terminal Bunker delivery 18.3 HP Storage PV – Terminal Bunker delivery
123	Detail HAZOP to be performed for the entire operation and appropriate safety to be in place	18.1 Hose – Terminal Bunker delivery 18.2 Compressor – Terminal Bunker delivery
124	Design needs to consider proper pressure management and control considering delivering bunker to multiple module and cylinder	18.1 Hose – Terminal Bunker delivery 18.2 Compressor – Terminal Bunker delivery
125	Proper selection of storage cylinder and piping to be further studied at detail design stage	18.3 HP Storage PV – Terminal Bunker delivery 18.4 Cooler Heat Exchanger – Terminal Bunker delivery
126	Detail process safety analysis to be performed and Process Safety Management are to be in place	18.1 Hose – Terminal Bunker delivery



## Appendix IX – HAZID Register Ro-Pax

1	Upper Bunkering Station
<p>Bunkering</p> <p>Section notes:</p> <ul style="list-style-type: none"> <li>- 2 bunkering stations located on port side: One open bunker station on tank deck and second one semi enclosed/enclosed on main deck. (passengers and pilot house will be on starboard side)</li> <li>- 1 loading line for H<sub>2</sub></li> <li>- bunkering infrastructures is outside of project scope, but team considers a cascade filling approach to minimise temperature variations, bunkering from onshore tanks at various pressures.</li> <li>- bunkering equipment/parts onboard: grounding cable, hoses, breakaway coupling etc., ESD valves on bunker manifold interlocked (so only 1 bunker station available), pressure transmitter &amp; temperature transmitter (on common bunker manifold, which has alarms and shutdowns to close the open bunker line), double block and bleed valves, blowdown valve, &amp; pressure relief valve</li> <li>- bunkering will load all the tanks at the same time with monitoring system to ensure tank volume %. This is to ensure the proper fill is achieved to avoid any over pressduring voyage and idle time due to whether changes.</li> <li>- each H<sub>2</sub> storage tank has temperature &amp; pressure transmitters (H, HH, L). H will provide alarm to take corrective action and HH will shut down supply ESD valve to each tank, pressure &amp; blowdown valves, double block and bleed (DB) valve to isolate each tank (i.e. for maintenance or inspection) without impacting other tanks.</li> <li>- tank PRV sizing is based on fire case.</li> <li>- H<sub>2</sub> tanks are ISO type 4 composite tanks with HDPE liner, which may lose integrity quickly upon fire (resins start melting)</li> <li>- philosophy is to minimise the number of potential leak points.</li> </ul>	

No.: 1		Upper Bunkering Station								
Item	Deviation	Causes	Consequences	Matrix	Severity	Likelihood	Risk	Safeguards	Recommendations	Comment
1.1	Leakage upstream of ESDV-001 valve (i.e., flange connections, QCDC connections, hose)	1. Leakage from flange connections, QCDC connections, hose due to improper connections, corrosions, wear and tear, vibration etc. <b>Comment:</b> - i.e., between ESD valve at bunker station and shore connection	1. H <sub>2</sub> leakage at top deck	Asset	2	C	Moderate	1. Upper Bunker Station is on open deck and designed such that the location of piping and equipment in an open area will quickly disperse H <sub>2</sub> in case of leaks 2. Proper manufacturing, system testing, and leak testing of H <sub>2</sub> piping, storage tank, system 3. Bunker station, H <sub>2</sub> storage area, and tank connection space are classified and restricted (minimizing personnel exposure in case of emergency and restricted access during bunkering) 4. Bunkering procedures include thermal image scan for hot spots or overheating before starting, equalizing the bunker lines to bunkering pressure from bunker vessel (250 bar max), and leak testing, and opening the H <sub>2</sub> storage tank valve 5. System design such that all piping is welded with no joints or connections (minimizing H <sub>2</sub> leakages)	1. Conduct Fire Hazards Analysis, Gas Dispersion Analysis, Explosion Analysis to establish hazardous area zones and hazardous impact. Provide appropriate mitigations for fire and explosion consequences. Evaluate if the vessel structural damage due to explosion can compromise the damage stability and integrity of the vessel. Evaluate the vent mast design and hazardous area zone established by the vent mast. 3. Study the effectiveness of permanent H <sub>2</sub> gas detector in the upper bunker station and as well as tank connection, manifolds and piping arrangement since the space is open. 4. Electrical groundings are to be provided for both shore and ship bunkering. 10. Per IGF Code, add automatic and manual isolation valves at the bunker manifold. The current design only shows one automatic shutdown valve.	

							<p>6. Crew continuously monitoring the bunkering operation and deck piping from a safe area</p> <p>7. Hydrogen, Fire &amp; Gas (F&amp;G) Detection System monitoring H<sub>2</sub> storage area &amp; bunkering station</p> <p>8. Pressure transmitters to monitor H<sub>2</sub> piping and piping annulus space (N<sub>2</sub>)</p> <p>9. Emergency Shutdown System (ESD) of H<sub>2</sub> storage system &amp; bunkering station.</p> <p>10. Monitoring crew to manually initiate emergency system shutdown by activating ESD push buttons in case of emergency</p> <p>12. Firefighting system: activation of water sprays in case of fire onboard, fire hose near bunker stations</p> <p>13. Crew is equipped with Personnel Protective Equipment (PPE)</p> <p>14. Bunkering crew is equipped with portable gas detectors</p> <p>15. Ship-to-Shore connections for ESD functions</p> <p>16. Electrical groundings/grounding reel provided between ship and terminal/bunker</p>	<p>94. After connections bunker lines pressure testing proper tightness/leak testing to be performed. e.g., with helium or 5% H<sub>2</sub>/N<sub>2</sub></p>	<p>- Both Bunkering station arrangements are open, will be used based on bunker infrastructure on land or on bunker vessel.</p> <ul style="list-style-type: none"> <li>- double walled piping extends inside the duct</li> <li>- cascade bunkering procedures to avoid extreme pressure drop</li> <li>- bunkering controls will be done from control station in each bunker station (away from the wheelhouse) and also duplicated onshore</li> <li>- vessel bunkering crew operating nearby in control station near each bunker station</li> <li>- preliminary fire hazard analysis establish expected jet fire size based on various factors</li> <li>- bunkering expected to last 30 mins</li> </ul>
--	--	--	--	--	--	--	---	---	---

No.: 1		Upper Bunkering Station								
Item	Deviation	Causes	Consequences	Matrix	Severity	Likelihood	Risk	Safeguards	Recommendations	Comment
								vessel 17. Blowdown system upon detection of leak and ESD		
			3. Personnel injury due to H <sub>2</sub> exposure (vessel bunkering crew operating nearby in control station near each bunker station)	Injury	4	B	High			
			4. Jet fire or flash fire	Overall	S4-Major	LB-Unlikely	High			
		2. Bunker hose failure due to fatigue, improper design/maintenance, etc.	2. H <sub>2</sub> leakage from Bunker Hose	Asset	2	C	Moderate	1. Upper Bunker Station is on open deck and designed such that the location of piping and equipment in an open area will quickly disperse H <sub>2</sub> in case of leaks 2. Proper manufacturing, system testing, and leak testing of H <sub>2</sub> piping, storage tank, system 3. Bunker station, H <sub>2</sub> storage area, and tank connection space are classified and restricted (minimizing personnel exposure in case of emergency and restricted access during bunkering)	1. Conduct Fire Hazards Analysis, Gas Dispersion Analysis, Explosion Analysis to establish hazardous area zones and hazardous impact. Provide appropriate mitigations for fire and explosion consequences. Evaluate if the vessel structural damage due to explosion can compromise the damage stability and integrity of the vessel. Evaluate the vent mast design and hazardous area zone established by the vent mast. 3. Study the effectiveness of permanent H <sub>2</sub> gas detector in the upper bunker station and as well as tank connection, manifolds and piping arrangement since the space is open.	

No.: 1		Upper Bunkering Station								
Item	Deviation	Causes	Consequences	Matrix	Severity	Likelihood	Risk	Safeguards	Recommendations	Comment
								4. Bunkering procedures include thermal image scan for hot spots or overheating before starting, equalizing the bunker lines to bunkering pressure from bunker vessel (250 bar max), and leak testing, and opening the H <sub>2</sub> storage tank valve 5. System design such that all piping is welded with no joints or connections (minimizing H <sub>2</sub> leakages) 6. Crew continuously monitoring the bunkering operation and deck piping from a safe area 7. Hydrogen, Fire & Gas (F&G) Detection System monitoring H <sub>2</sub> storage area & bunkering station 8. Pressure transmitters to monitor H <sub>2</sub> piping and piping annulus space (N <sub>2</sub> ) 9. Emergency Shutdown System (ESD) of H <sub>2</sub> storage system & bunkering station.	4. Electrical groundings are to be provided for both shore and ship bunkering. 94. After connections bunker lines pressure testing proper tightness/leak testing to be performed. e.g., with helium or 5% H <sub>2</sub> /N <sub>2</sub>	

No.: 1		Upper Bunkering Station								
Item	Deviation	Causes	Consequences	Matrix	Severity	Likelihood	Risk	Safeguards	Recommendations	Comment
								10. Monitoring crew to manually initiate emergency system shutdown by activating ESD push buttons in case of emergency 11. Pressure Relief System (PSV 21-PR-02) on the H <sub>2</sub> bunker line to relieve pressure 12. Firefighting system: activation of water sprays in case of fire onboard, fire hose near bunker stations 13. Crew is equipped with Personnel Protective Equipment (PPE) 14. Bunkering crew is equipped with portable gas detectors 15. Ship-to-Shore connections for ESD functions 16. Electrical groundings/grounding reel provided between ship and terminal/bunker vessel 17. Blowdown system upon detection of leak and ESD		
			3. Personnel injury due to H <sub>2</sub> exposure (vessel bunkering crew operating nearby in control station near each bunker station)	Injury	4	B	High			

No.: 1		Upper Bunkering Station								
Item	Deviation	Causes	Consequences	Matrix	Severity	Likelihood	Risk	Safeguards	Recommendations	Comment
			4. Jet fire or flash fire	Overall	S4-Major	LB-Unlikely	High			
1.2	Leakage downstream of ESDV-001 valve	1. Leakage from seal, connections, valve gland, corrosions, wear and tear, vibration, mechanical damage, etc. <b>Comment:</b> Piping between ESDV 001 and tank stop valve	1. H <sub>2</sub> leakage at top deck	Asset	2	C	Moderate	1. Upper Bunker Station is designed such that the location of piping and equipment in an open area will quickly disperse H <sub>2</sub> in case of leaks 2. Proper manufacturing, system testing, and leak testing of H <sub>2</sub> piping, storage tank, system 3. Bunker station, H <sub>2</sub> storage area, and tank connection space are classified and restricted (minimizing personnel exposure in case of emergency and restricted access during bunkering) 4. Bunkering procedures include thermal image scan for hot spots or overheating before starting, equalizing the bunker lines to bunkering pressure from bunker vessel (250 bar max), and leak testing, and opening the H <sub>2</sub> storage tank valve 5. System design such that all piping is welded with no joints or connections (minimizing H <sub>2</sub> leakages)	1. Conduct Fire Hazards Analysis, Gas Dispersion Analysis, Explosion Analysis to establish hazardous area zones and hazardous impact. Provide appropriate mitigations for fire and explosion consequences. Evaluate if the vessel structural damage due to explosion can compromise the damage stability and integrity of the vessel. Evaluate the vent mast design and hazardous area zone established by the vent mast. 3. Study the effectiveness of permanent H <sub>2</sub> gas detector in the upper bunker station and as well as tank connection, manifolds and piping arrangement since the space is open.	- tank failure mode due to temperature to be discussed - Piping between ESDV 001 and tank stop valve

No.: 1		Upper Bunkering Station								
Item	Deviation	Causes	Consequences	Matrix	Severity	Likelihood	Risk	Safeguards	Recommendations	Comment
								6. Crew continuously monitoring the bunkering operation and deck piping from a safe area 7. Hydrogen, Fire & Gas (F&G) Detection System monitoring H <sub>2</sub> storage area & bunkering station 8. Pressure transmitters to monitor H <sub>2</sub> piping and piping annulus space (N <sub>2</sub> ) 9. Emergency Shutdown System (ESD) of H <sub>2</sub> storage system & bunkering station. 10. Monitoring crew to manually initiate emergency system shutdown by activating ESD push buttons in case of emergency 11. Pressure Relief System (PSV 21-PR-02) on the H <sub>2</sub> bunker line to relieve pressure 12. Firefighting system: activation of water sprays in case of fire onboard, fire hose near bunker stations 13. Crew is equipped with Personnel Protective Equipment (PPE)	5. Develop bunkering procedures including the bunkering pressure and temperature in the H <sub>2</sub> storage tank to stay within tank design limits. Also, develop bunkering restrictions to avoid bunkering during adverse weather (rain, lightning, etc.) which can lead to connections overload, gas leakage, etc. 94. After connections bunker lines pressure testing proper tightness/leak testing to be performed. e.g., with helium or 5% H <sub>2</sub> /N <sub>2</sub>	



No.: 1		Upper Bunkering Station								
Item	Deviation	Causes	Consequences	Matrix	Severity	Likelihood	Risk	Safeguards	Recommendations	Comment
								14. Bunkering crew is equipped with portable gas detectors 15. Ship-to-Shore connections for ESD functions 16. Blowdown system upon detection of leak and ESD		
			2. Personnel injury due to H <sub>2</sub> exposure (vessel bunkering crew operating nearby in control station near each bunker station)	Injury	4	B	High			
			3. Jet fire or flash fire or explosion	Overall	S4-Major	LB-Unlikely	High			
1.3	High temperature in bunker line	1. Reverse JT effect or adiabatic compression	1. Higher temperature of H <sub>2</sub> supply than operating limits	Asset	2	C	Moderate	1. Bunker station, H <sub>2</sub> storage area, and tank connection space are classified and restricted (minimizing personnel exposure in case of emergency and restricted access during bunkering) 2. Bunkering procedures include thermal image scan for hot spots or overheating before starting, equalizing the bunker lines to bunkering pressure from bunker vessel (250 bar max), and leak testing, and opening the H <sub>2</sub> storage tank valve	6. Develop pressure and temperature management plan and bunkering checklists for H <sub>2</sub> bunkering system, H <sub>2</sub> piping, and H <sub>2</sub> storage system.	

No.: 1		Upper Bunkering Station								
Item	Deviation	Causes	Consequences	Matrix	Severity	Likelihood	Risk	Safeguards	Recommendations	Comment
								3. Temperature transmitters TT-001 to monitor temperature at the bunkering station and provide alarms (H,L) and shutdown (HH) 4. Temperature transmitters at each H <sub>2</sub> Storage Tank to provide alarms (L,H) and shutdowns (HH) 5. Crew continuously monitoring the bunkering operation from a safe area 6. Hydrogen, Fire & Gas (F&G) Detection System monitoring H <sub>2</sub> storage area & bunkering station 7. Emergency Shutdown System (ESD) of H <sub>2</sub> storage system & bunkering station 8. Monitoring crew to manually initiate emergency system shutdown by activating ESD push buttons in case of emergency 9. Crew is equipped with Personnel Protective Equipment (PPE) 10. Bunkering crew is equipped with portable gas detectors		

No.: 1		Upper Bunkering Station								
Item	Deviation	Causes	Consequences	Matrix	Severity	Likelihood	Risk	Safeguards	Recommendations	Comment
								11. H <sub>2</sub> Storage Tank Design such that the tank temperature & pressure operating conditions are within the design limits per tank manufacturer's specifications (i.e., 20 bar normal operating pressure)		
			2. Compromised H <sub>2</sub> storage tank integrity due to high temperature	Asset	2	C	Moderate			
			3. Tank failure, damage	Asset	3	B	Moderate			
		2. H <sub>2</sub> supply delivered at higher temperature than operating limits	1. Higher temperature of H <sub>2</sub> supply than operating limits	Asset	2	C	Moderate	1. Bunker station, H <sub>2</sub> storage area, and tank connection space are classified and restricted (minimizing personnel exposure in case of emergency and restricted access during bunkering) 2. Bunkering procedures include thermal image scan for hot spots or overheating before starting, equalizing the bunker lines to bunkering pressure from bunker vessel (250 bar max), and leak testing, and opening the H <sub>2</sub> storage tank valve 3. Temperature transmitters TT-001 to monitor temperature at the bunkering station and provide alarms (H, L) and shutdown (HH)	6. Develop pressure and temperature management plan and bunkering checklists for H <sub>2</sub> bunkering system, H <sub>2</sub> piping, and H <sub>2</sub> storage system.	

No.: 1		Upper Bunkering Station								
Item	Deviation	Causes	Consequences	Matrix	Severity	Likelihood	Risk	Safeguards	Recommendations	Comment
								4. Temperature transmitters at each H <sub>2</sub> Storage Tank to provide alarms (L, H) and shutdowns (HH) 5. Crew continuously monitoring the bunkering operation from a safe area 6. Hydrogen, Fire & Gas (F&G) Detection System monitoring H <sub>2</sub> storage area & bunkering station 7. Emergency Shutdown System (ESD) of H <sub>2</sub> storage system & bunkering station 8. Monitoring crew to manually initiate emergency system shutdown by activating ESD push buttons in case of emergency 9. Crew is equipped with Personnel Protective Equipment (PPE) 10. Bunkering crew is equipped with portable gas detectors 11. H <sub>2</sub> Storage Tank Design such that the tank temperature & pressure operating conditions are within the design limits per tank manufacturer's specifications (i.e., 20 bar normal operating pressure)		

No.: 1		Upper Bunkering Station								
Item	Deviation	Causes	Consequences	Matrix	Severity	Likelihood	Risk	Safeguards	Recommendations	Comment
			2. Compromised H <sub>2</sub> storage tank integrity due to high temperature	Asset	2	C	Moderate			
			3. Tank failure, damage	Asset	3	B	Moderate			
1.4	Vessel motion	1. High wind/wave	1. Bunkering connection overload, breaking at bunker manifold	Asset	1	C	Low		8. Conduct berthing analysis, evaluate additional protections, establish operational restrictions to minimise the impact of adverse vessel motions. Consider the maximum wave and motion that can be generated from passing vessels. 9. Evaluate hose design considering potential adverse vessel motion, impact on equipment, and mooring loads. 95. Proper hose support is to be provided to prevent hose damage, hitting the hull and chaffing.	- vessel movement relative to the quay side, along the pier - bunker hose material is rubber
			2. High load on the bunker hose	Asset	2	C	Moderate			
			3. Hose entanglement	Asset	2	C	Moderate			
			4. Damage to bunker hose, damage/breaking at bunker manifold	Asset	3	C	High			

No.: 1		Upper Bunkering Station								
Item	Deviation	Causes	Consequences	Matrix	Severity	Likelihood	Risk	Safeguards	Recommendations	Comment
		2. Swell due to passing traffic	1. Bunkering connection overload, breaking at bunker manifold	Asset	1	C	Low		8. Conduct berthing analysis, evaluate additional protections, establish operational restrictions to minimise the impact of adverse vessel motions. Consider the maximum wave and motion that can be generated from passing vessels. 9. Evaluate hose design considering potential adverse vessel motion, impact on equipment, and mooring loads. 96. Consider working with port authority to develop safe zone and passing traffic speed restriction	
			2. High load on the bunker hose	Asset	2	C	Moderate			
			3. Hose entanglement	Asset	2	C	Moderate			
			4. Damage to bunker hose, damage/breaking at bunker manifold	Asset	3	C	High			
1.5	Blockage leading to bunker line over pressurisation	1. Inadvertent closure of inlet valves, operator error, valves not open, wrong lineup of valves, etc.	1. Over pressurisation of bunker line	Asset	2	C	Moderate	1. Upper Bunker Station is designed such that the location of piping and equipment in an open area will quickly disperse H <sub>2</sub> in case of leaks	3. Study the effectiveness of permanent H <sub>2</sub> gas detector in the upper bunker station and as well as tank connection, manifolds and piping arrangement since the space is open.	- bunker piping is double wall up to the H <sub>2</sub> storage tanks

No.: 1		Upper Bunkering Station								
Item	Deviation	Causes	Consequences	Matrix	Severity	Likelihood	Risk	Safeguards	Recommendations	Comment
								2. Proper manufacturing, system testing, and leak testing of H <sub>2</sub> piping, storage tank, system 3. Bunker station, H <sub>2</sub> storage area, and tank connection space are classified and restricted (minimizing personnel exposure in case of emergency and restricted access during bunkering) 5. Crew continuously monitoring the bunkering operation from a safe area 6. Hydrogen, Fire & Gas (F&G) Detection System monitoring H <sub>2</sub> storage area & bunkering station 7. Pressure transmitters to monitor H <sub>2</sub> piping and piping annulus space (N <sub>2</sub> ) 8. Pressure transmitter PIA-001 to monitor pressure and provide alarms (H, L) 9. Emergency Shutdown System (ESD) of H <sub>2</sub> storage system & bunkering station. 10. Pressure Relief System (PSV 21-PR-02) on the H <sub>2</sub> bunker line to relieve pressure	11. Conduct detailed HAZOP at later engineering phase when system details (C&E Chart, P&IDs) are available H <sub>2</sub> storage system, Fuel Cell, etc. 12. Consider adding HH pressure shutdown to pressure transmitter PIA-001 at upper bunker station downstream of ESDV-001. Evaluate the expected volume of H <sub>2</sub> (expected low) in the bunker line between ESDV-001 and DB-01, and ESDV-001 to ESD valves on H <sub>2</sub> storage tanks. 100. Develop detail operational procedure and training	

No.: 1		Upper Bunkering Station								
Item	Deviation	Causes	Consequences	Matrix	Severity	Likelihood	Risk	Safeguards	Recommendations	Comment
								11. Monitoring crew to manually initiate emergency system shutdown by activating ESD push buttons in case of emergency 12. Firefighting system: activation of water sprays in case of fire onboard, fire hose near bunker stations 13. Crew is equipped with Personnel Protective Equipment (PPE) 14. Bunkering crew is equipped with portable gas detectors		
			2. H <sub>2</sub> leakage	Asset	2	C	Moderate			
			3. Personnel injury due to H <sub>2</sub> exposure (vessel bunkering crew operating nearby in control station near each bunker station)	Injury	4	B	High			
			4. H <sub>2</sub> leakage, Jet fire or flash fire	Overall	S4-Major	LB-Unlikely	High			



No.: 1		Upper Bunkering Station								
Item	Deviation	Causes	Consequences	Matrix	Severity	Likelihood	Risk	Safeguards	Recommendations	Comment
1.6	H <sub>2</sub> contamination in H <sub>2</sub> bunkering line (i.e., oxygen)	1. Improper purging leading to H <sub>2</sub> contaminated with O <sub>2</sub>	1. Contaminated H <sub>2</sub> in H <sub>2</sub> storage tank/piping	Asset	2	C	Moderate	1. After initial use, the H <sub>2</sub> pressure will be maintained at 20 bar (nominal) in the bunkering system 2. Bunker station, H <sub>2</sub> storage area, and tank connection space are classified and restricted (minimizing personnel exposure in case of emergency and restricted access during bunkering) 3. Bunkering procedures include thermal image scan for hot spots or overheating before starting, equalizing the bunker lines to bunkering pressure from bunker vessel (250 bar max), and leak testing, and opening the H <sub>2</sub> storage tank valve 4. Crew continuously monitoring the bunkering operation from a safe area 5. Monitoring crew to manually initiate emergency system shutdown by activating ESD push buttons in case of emergency 6. Crew is equipped with Personnel Protective Equipment (PPE) 7. Bunkering crew is equipped with portable gas detectors	13. Develop detailed gassing, degassing, and purging procedures and fuel management plan (per IGF code) for bunkering operations. 101. Add connection for O <sub>2</sub> /N <sub>2</sub> concentration monitoring during purging	- prior to bunkering, check H <sub>2</sub> pressures and maintaining H <sub>2</sub> bunkering line pressure (20 bar nominal). - purging bunkering system prior to bunkering - Type 4 tank CCPV with HDPE liner which will not lead to significant corrosion issues.

No.: 1		Upper Bunkering Station								
Item	Deviation	Causes	Consequences	Matrix	Severity	Likelihood	Risk	Safeguards	Recommendations	Comment
			2. Flammable mixture in H <sub>2</sub> storage tank	Asset	3	B	Moderate			
			3. H <sub>2</sub> mix with )2 - deflagration/detonation etc.	Overall	S4-Major	LC-Possible	Extreme			
1.7	H <sub>2</sub> leakage from bunker line when it is maintained at 20 bar nominal pressure	1. H <sub>2</sub> leakage from connections due to mechanical failure, marine load, wear and tear, seal failure, valve leakage, etc.	1. H <sub>2</sub> leakage creating hazardous area	Asset	2	C	Moderate	<p>1. Upper Bunker Station is designed such that the location of piping and equipment in an open area will quickly disperse H<sub>2</sub> in case of leaks</p> <p>2. Proper manufacturing, system testing, and leak testing of H<sub>2</sub> piping, storage tank, system</p> <p>3. Bunker station, H<sub>2</sub> storage area, and tank connection space are classified and restricted (minimizing personnel exposure in case of emergency and restricted access during bunkering)</p> <p>4. Bunkering procedures include thermal image scan for hot spots or overheating before starting, equalizing the bunker lines to bunkering pressure from bunker vessel (250 bar max), and leak testing, and opening the H<sub>2</sub> storage tank valve</p>	<p>1. Conduct Fire Hazards Analysis, Gas Dispersion Analysis, Explosion Analysis to establish hazardous area zones and hazardous impact. Provide appropriate mitigations for fire and explosion consequences. Evaluate if the vessel structural damage due to explosion can compromise the damage stability and integrity of the vessel. Evaluate the vent mast design and hazardous area zone established by the vent mast.</p> <p>11. Conduct detailed HAZOP at later engineering phase when system details (C&amp;E Chart, P&amp;IDs) are available H<sub>2</sub> storage system, Fuel Cell, etc.</p>	<p>- during voyage, the line from ESDV-001 to DB-01 will be kept at 20 bar nominal pressure.</p> <p>- bunkering line pressure is at 20 bar nominal from bunker isolation valve</p> <p>- per IGF code, bunker line to be purged after bunkering operations. For this project that is not the case.</p> <p>- bunker station is port side, and restricted entry.</p>

No.: 1		Upper Bunkering Station								
Item	Deviation	Causes	Consequences	Matrix	Severity	Likelihood	Risk	Safeguards	Recommendations	Comment
								5. System design such that H <sub>2</sub> volume is very low in the line, minimizing the severity of release 6. System design such that all piping is welded with no joints or connections (minimizing H <sub>2</sub> leakages) 7. Crew continuously monitoring the bunkering operation from a safe area 8. Hydrogen, Fire & Gas (F&G) Detection System monitoring H <sub>2</sub> storage area & bunkering station 10. Pressure transmitter PIA-001 to monitor pressure and provide alarms (H, L) 12. Emergency Shutdown System (ESD) of H <sub>2</sub> storage system & bunkering station 13. Firefighting system: activation of water sprays in case of fire onboard 14. Crew is equipped with Personnel Protective Equipment (PPE) 15. Bunkering crew is equipped with portable gas detectors 16. Pressure monitoring of bunker line	12. Consider adding HH pressure shutdown to pressure transmitter PIA-001 at upper bunker station downstream of ESDV-001. Evaluate the expected volume of H <sub>2</sub> (expected low) in the bunker line between ESDV-001 and DB-01, and ESDV-001 to ESD valves on H <sub>2</sub> storage tanks.  102. Consider developing an action plan for detection of leaks in bunker manifold during various stages of operation when bunkering is not done and mitigating action. Consider blowdown and purge to gain control on situation.	

No.: 1		Upper Bunkering Station								
Item	Deviation	Causes	Consequences	Matrix	Severity	Likelihood	Risk	Safeguards	Recommendations	Comment
								17. Blowdown and purge of bunker line, ESD upon gas detection or pressure loss		
			4. Jet Fire & Flash Fire	Overall	S4-Major	LB-Unlikely	High			
			5. Unable to bunker, delay	Overall	S2-Minor	LC-Possible	Moderate			
		2. Unable to purge the bunker hose <b>Comment:</b> - not expected to have impact on the PEM Fuel Cell system since the H <sub>2</sub> supply to PEM Fuel Cell will also be purged with N <sub>2</sub> before going into a PEM Fuel Cell stack (FC manufacturer's safeguard)	2. H <sub>2</sub> contamination with O <sub>2</sub> in the bunker line	Asset	2	C	Moderate	2. Proper manufacturing, system testing, and leak testing of H <sub>2</sub> piping, storage tank, system 3. Bunker station, H <sub>2</sub> storage area, and tank connection space are classified and restricted (minimizing personnel exposure in case of emergency and restricted access during bunkering) 4. Bunkering procedures include thermal image scan for hot spots or overheating before starting, equalizing the bunker lines to bunkering pressure from bunker vessel (250 bar max), and leak testing, and opening the H <sub>2</sub> storage tank valve 7. Crew continuously monitoring the bunkering operation from a safe area	14. Conduct detailed study on purging operations as the bunkering manifold is already pressurised and there is no N <sub>2</sub> connection after the ESDV-001 valve. The scenario discussed is if there is an inability to purge the bunker hose, there is potential for H <sub>2</sub> contamination with O <sub>2</sub> in the bunker line, leading to flammable mixture. 15. Consult with Fuel Cell manufacturer on the H <sub>2</sub> purity requirements, potential impact of H <sub>2</sub> contamination (with O <sub>2</sub> , CO, NH <sub>3</sub> , H <sub>2</sub> O), and ensure that H <sub>2</sub> storage & supply systems and downstream systems are delivering H <sub>2</sub> at design limits.	

No.: 1		Upper Bunkering Station								
Item	Deviation	Causes	Consequences	Matrix	Severity	Likelihood	Risk	Safeguards	Recommendations	Comment
								8. Hydrogen, Fire & Gas (F&G) Detection System monitoring H <sub>2</sub> storage area & bunkering station 9. Oxygen detector AQA-005 to provide alarm (L) and shutdown (LL) 10. Pressure transmitter PIA-001 to monitor pressure and provide alarms (H, L) 11. Pressure transmitter PIA-012 at the H <sub>2</sub> supply line to provide alarms (H, L) and shutdowns (HH) 12. Emergency Shutdown System (ESD) of H <sub>2</sub> storage system & bunkering station 13. Firefighting system: activation of water sprays in case of fire onboard 14. Crew is equipped with Personnel Protective Equipment (PPE) 15. Bunkering crew is equipped with portable gas detectors		
			3. Flammable mixture due to H <sub>2</sub> & O <sub>2</sub> mixture	Asset	3	B	Moderate			
			4. Jet Fire & Flash Fire	Overall	S4-Major	LB-Unlikely	High			
			5. Unable to bunker, delay	Overall	S2-Minor	LC-Possible	Moderate			
			6. Unable to disconnect bunker hose	Asset	3	D	High			

No.: 1		Upper Bunkering Station								
Item	Deviation	Causes	Consequences	Matrix	Severity	Likelihood	Risk	Safeguards	Recommendations	Comment
1.8	Backflow of H <sub>2</sub> into N <sub>2</sub> line	1. Backflow of H <sub>2</sub> into N <sub>2</sub> line	1. Contamination of H <sub>2</sub> with N <sub>2</sub>	Asset	2	C	Moderate	1. Upper Bunker Station is designed such that the location of piping and equipment in an open area will quickly disperse H <sub>2</sub> in case of leaks 2. Proper manufacturing, system testing, and leak testing of H <sub>2</sub> piping, storage tank, system 3. Bunker station, H <sub>2</sub> storage area, and tank connection space are classified and restricted (minimizing personnel exposure in case of emergency and restricted access during bunkering) 4. Bunkering procedures include thermal image scan for hot spots or overheating before starting, equalizing the bunker lines to bunkering pressure from bunker vessel (250 bar max), and leak testing, and opening the H <sub>2</sub> storage tank valve 5. System design such that all piping is welded with no joints or connections (minimizing H <sub>2</sub> leakages)	11. Conduct detailed HAZOP at later engineering phase when system details (C&E Chart, P&IDs) are available H <sub>2</sub> storage system, Fuel Cell, etc. 16. Consider adding an isolation valve, i.e., double block and bleed valve or non-return valve (NRV), to the N <sub>2</sub> connection line. 103. Detail procedure to be developed for N <sub>2</sub> use/purging etc. as there can be high risk of H <sub>2</sub> back flow into N <sub>2</sub> stream.	- N <sub>2</sub> line will be at lower pressure than H <sub>2</sub>

No.: 1		Upper Bunkering Station								
Item	Deviation	Causes	Consequences	Matrix	Severity	Likelihood	Risk	Safeguards	Recommendations	Comment
								6. Crew continuously monitoring the bunkering operation from a safe area 7. Hydrogen, Fire & Gas (F&G) Detection System monitoring H <sub>2</sub> storage area & bunkering station 8. Oxygen detector AQA-005 to provide alarm (L) and shutdown (LL) 9. Pressure transmitter PIA-001 to monitor pressure and provide alarms (H, L) 10. Pressure transmitter PIA-012 at the H <sub>2</sub> supply line to provide alarms (H, L) and shutdowns (HH) 11. Emergency Shutdown System (ESD) of H <sub>2</sub> storage system & bunkering station 12. Firefighting system: activation of water sprays in case of fire onboard 13. Crew is equipped with Personnel Protective Equipment (PPE) 14. Bunkering crew is equipped with portable gas detectors		
			2. Over pressurisation of N <sub>2</sub> line	Asset	2	C	Moderate			
			3. H <sub>2</sub> leakage into safe space (N <sub>2</sub> bottles located in safe space)	Asset	2	C	Moderate			

No.: 1		Upper Bunkering Station								
Item	Deviation	Causes	Consequences	Matrix	Severity	Likelihood	Risk	Safeguards	Recommendations	Comment
			4. Jet Fire & Flash Fire	Overall	S4-Major	LB-Unlikely	High			
1.9	Dropped Objects on bunkering line during bunkering	1. Dropped Objects	1. Bunker line damage	Asset	2	B	Low	1. Lifting Plan and Procedures will ensure no overhead lifting around bunkering station & H <sub>2</sub> storage area during bunkering 2. No overhead structures (bridges, cranes) on the designated ferry route 3. Protective framework above H <sub>2</sub> storage area which also include a mesh to allow H <sub>2</sub> dispersion (protect against dropped objects, weather exposure such as hailstorm) 4. Upper Bunker Station is designed such that the location of piping and equipment in an open area will quickly disperse H <sub>2</sub> in case of leaks 5. Bunker station, H <sub>2</sub> storage area, and tank connection space are classified and restricted (minimizing personnel exposure in case of emergency and restricted access during bunkering) 6. Hydrogen, Fire & Gas (F&G) Detection System monitoring H <sub>2</sub> storage area & bunkering station	17. Develop operational procedures to ensure no overhead lifting when Fuel Cell system is running with H <sub>2</sub> supply and have restrictions in place to prevent dropped object impact on H <sub>2</sub> storage system, H <sub>2</sub> piping and H <sub>2</sub> bunkering lines.	- lifting plan & procedures will restrict lifting above bunker lines and no SIMOPs during bunkering near the bunkering station



No.: 1		Upper Bunkering Station								
Item	Deviation	Causes	Consequences	Matrix	Severity	Likelihood	Risk	Safeguards	Recommendations	Comment
								7. Crew continuously monitoring the bunkering operation from a safe area 8. Monitoring crew to manually initiate emergency system shutdown by activating ESD push buttons in case of emergency 9. Firefighting system: activation of water sprays in case of fire onboard 10. Crew is equipped with Personnel Protective Equipment (PPE) 11. Bunkering crew is equipped with portable gas detectors 12. Blast wall protecting pilot house		
			2. H <sub>2</sub> leakage leading to flammable mixture	Asset	3	B	Moderate			
			3. Jet Fire/ Flash Fire, explosion/blast	Overall	S4-Major	LA-Rare	High			

No.: 1		Upper Bunkering Station								
Item	Deviation	Causes	Consequences	Matrix	Severity	Likelihood	Risk	Safeguards	Recommendations	Comment
1.10	Adverse weather, Low lighting during bunkering	1. Adverse weather (high wind, rain, lightning, etc.) (linked from 1.4) <b>Comment:</b> see scenario 1.4							5. Develop bunkering procedures including the bunkering pressure and temperature in the H <sub>2</sub> storage tank to stay within tank design limits. Also, develop bunkering restrictions to avoid bunkering during adverse weather (rain, lightning, etc.) which can lead to connections overload, gas leakage, etc.	- bunkering will be done at night
		2. Low lighting leading to human error during bunkering <b>Comment:</b> - bunkering will be done at night - 20 LUX harbor area lighting	1. Bunkering equipment damage	Asset	2	C	Moderate	1. Bunker station, H <sub>2</sub> storage area, and tank connection space are classified and restricted (minimizing personnel exposure in case of emergency and restricted access during bunkering) 2. Bunkering procedures include thermal image scan for hot spots or overheating before starting, equalizing the bunker lines to bunkering pressure from bunker vessel (250 bar max), and leak testing, and opening the H <sub>2</sub> storage tank valve 3. Hydrogen, Fire & Gas (F&G) Detection System monitoring H <sub>2</sub> storage area & bunkering station	18. Ensure that there is adequate lighting on the ferry and onshore and consider low lighting impacts in bunkering study and bunkering procedures. Lighting equipment is to be EX-rated based on hazardous area zone classification. 104. Consider lighting study considering night operation and human.	

No.: 1		Upper Bunkering Station								
Item	Deviation	Causes	Consequences	Matrix	Severity	Likelihood	Risk	Safeguards	Recommendations	Comment
								4. Crew continuously monitoring the bunkering operation from a safe area 5. Monitoring crew to manually initiate emergency system shutdown by activating ESD push buttons in case of emergency 6. Firefighting system: activation of water sprays in case of fire onboard 7. Crew is equipped with Personnel Protective Equipment (PPE) 8. Bunkering crew is equipped with portable gas detectors		
			2. H <sub>2</sub> leakage creating flammable mixture	Asset	2	C	Moderate			
			3. Jet Fire & Flash Fire	Overall	S4-Major	LB-Unlikely	High			
1.11	High pressure	1. H <sub>2</sub> supply delivered at higher pressure than limits	2. Higher pressure in bunker piping and H <sub>2</sub> storage tank than operating limits	Asset	1	B	Low	1. Bunker station, H <sub>2</sub> storage area, and tank connection space are classified and restricted (minimizing personnel exposure in case of emergency and restricted access during bunkering)	7. Develop proper bunkering plan considering the H <sub>2</sub> storage tank charge pressure and settle pressure considering atmospheric condition and temperature. 105. Fuel management details and procedure are to be developed per IGF code	

No.: 1		Upper Bunkering Station								
Item	Deviation	Causes	Consequences	Matrix	Severity	Likelihood	Risk	Safeguards	Recommendations	Comment
								2. Bunkering procedures include thermal image scan for hot spots or overheating before starting, equalizing the bunker lines to bunkering pressure from bunker vessel (250 bar max), and leak testing, and opening the H <sub>2</sub> storage tank valve 3. H <sub>2</sub> Storage Tank Design such that the tank temperature & pressure operating conditions are within the design limits per tank manufacturer's specifications (i.e., 20 bar normal operating pressure) 4. Crew continuously monitoring the bunkering operation from a safe area 5. Hydrogen, Fire & Gas (F&G) Detection System monitoring H <sub>2</sub> storage area & bunkering station 6. Pressure transmitters to monitor H <sub>2</sub> piping and piping annulus space (N <sub>2</sub> ) 7. Pressure transmitters at each H <sub>2</sub> Storage Tank to provide alarms (L, H) and shutdowns (HH)		

No.: 1		Upper Bunkering Station								
Item	Deviation	Causes	Consequences	Matrix	Severity	Likelihood	Risk	Safeguards	Recommendations	Comment
								8. Emergency Shutdown System (ESD) of H <sub>2</sub> storage system & bunkering station 9. Monitoring crew to manually initiate emergency system shutdown by activating ESD push buttons in case of emergency 10. Blowdown of H <sub>2</sub> inventory in H <sub>2</sub> storage tanks & piping 11. Pressure Relief System (PSV 21-PR-02) on the H <sub>2</sub> bunker line to relieve pressure 12. Pressure Relief Valves on H <sub>2</sub> Storage Tank 13. Crew is equipped with Personnel Protective Equipment (PPE) 14. Bunkering crew is equipped with portable gas detectors		
			3. Bunkering equipment damage	Asset	3	B	Moderate			
		2. Fill/Charge pressure and temperature	1. Higher charge pressure and temperature leading to higher settle pressure than operating limits	Asset	1	B	Low	1. Bunker station, H <sub>2</sub> storage area, and tank connection space are classified and restricted (minimizing personnel exposure in case of emergency and restricted access during bunkering)	7. Develop proper bunkering plan considering the H <sub>2</sub> storage tank charge pressure and settle pressure considering atmospheric condition and temperature.	

No.: 1		Upper Bunkering Station								
Item	Deviation	Causes	Consequences	Matrix	Severity	Likelihood	Risk	Safeguards	Recommendations	Comment
								2. Bunkering procedures include thermal image scan for hot spots or overheating before starting, equalizing the bunker lines to bunkering pressure from bunker vessel (250 bar max), and leak testing, and opening the H <sub>2</sub> storage tank valve 3. H <sub>2</sub> Storage Tank Design such that the tank temperature & pressure operating conditions are within the design limits per tank manufacturer's specifications (i.e., 20 bar normal operating pressure) 4. Crew continuously monitoring the bunkering operation from a safe area 5. Hydrogen, Fire & Gas (F&G) Detection System monitoring H <sub>2</sub> storage area & bunkering station 6. Pressure transmitters to monitor H <sub>2</sub> piping and piping annulus space (N <sub>2</sub> ) 7. Pressure transmitters at each H <sub>2</sub> Storage Tank to provide alarms (L, H) and shutdowns (HH)		

No.: 1		Upper Bunkering Station								
Item	Deviation	Causes	Consequences	Matrix	Severity	Likelihood	Risk	Safeguards	Recommendations	Comment
								8. Emergency Shutdown System (ESD) of H <sub>2</sub> storage system & bunkering station 9. Monitoring crew to manually initiate emergency system shutdown by activating ESD push buttons in case of emergency 10. Blowdown of H <sub>2</sub> inventory in H <sub>2</sub> storage tanks & piping 11. Pressure Relief System (PSV 21-PR-02) on the H <sub>2</sub> bunker line to relieve pressure 12. Pressure Relief Valves on H <sub>2</sub> Storage Tank 13. Crew is equipped with Personnel Protective Equipment (PPE) 14. Bunkering crew is equipped with portable gas detectors		
			2. Higher pressure in bunker piping and H <sub>2</sub> storage tank than operating limits	Asset	1	B	Low			
			3. Bunkering equipment damage	Asset	3	B	Moderate			

2	Lower Bunker Station
Section notes: - see node 1 for other bunkering scenarios discussed in the study - during voyage, the door to the enclosed Lower Bunker Station will be closed. - Lower Bunker Station will have a weather-tight door. This will be a closed space during voyage and Semi-enclosed space during bunkering operation.	

No.: 2		Lower Bunker Station								
Item	Deviation	Causes	Consequences	Matrix	Severity	Likelihood	Risk	Safeguards	Recommendations	Comment
2.1	See Node 1 - Upper Bunkering Station for other bunkering related hazards.									



No.: 2		Lower Bunker Station								
Item	Deviation	Causes	Consequences	Matrix	Severity	Likelihood	Risk	Safeguards	Recommendations	Comment
2.2	H <sub>2</sub> leakage inside Lower Bunker Station	1. Leakage from flange connections, QCDC connections, hose due to improper connections, corrosions, wear and tear, vibration etc.	1. H <sub>2</sub> leakage inside Lower bunker Station	Asset	2	C	Moderate	1. Proper manufacturing, system testing, and leak testing of H <sub>2</sub> piping, storage tank, system 2. Bunker station, H <sub>2</sub> storage area, and tank connection space are classified and restricted (minimizing personnel exposure in case of emergency and restricted access during bunkering) 3. Bunkering procedures include thermal image scan for hot spots or overheating before starting, equalizing the bunker lines to bunkering pressure from bunker vessel (250 bar max), and leak testing, and opening the H <sub>2</sub> storage tank valve 4. System design such that all piping are welded with no joints or connections (minimizing H <sub>2</sub> leakages) 5. Crew continuously monitoring the bunkering operation from a safe area	19. Consider sloped ceilings in the design to minimise the potential for gas accumulation in case of H <sub>2</sub> leak inside the Lower Bunker Station. Also, examine any dead spaces for potential H <sub>2</sub> accumulation. 20. Develop design details for the space above the Lower Bunker Station as details are not currently available during HAZID workshop. Reconsider the void space in the area or add additional gas detectors to detect potential H <sub>2</sub> accumulation. 21. Consider designing the void space as gas tight space and inerted or designing the H <sub>2</sub> bunker piping as double walled piping at the Lower Bunkering Station.	<ul style="list-style-type: none"> <li>- control station is inside Lower Bunker Station</li> <li>- casing is sealed off</li> <li>- outboard (seaside) of the Lower Bunker Station is open</li> <li>- Bunker Station has a side opening and the opening height is extended to the top ceiling, so there is no gas accumulation in case of leak.</li> <li>- vehicle deck (main deck) is watertight and there is drain outlet. In case of water accumulation, which will be drained automatically.</li> <li>- bunker H<sub>2</sub> piping (external pipe, single wall) is outside of the fuel cell void space (exhaust ducting) and goes from bunker station to wheelhouse on bridge deck, and without passing through internal space.</li> <li>- current design philosophy is to keep the H<sub>2</sub> bunker line pressurised (20 bar nominal) and not inerted when not bunkering. During bunkering, the Lower Bunkering Station is considered to be a hazardous area. Equipment will be rated per hazardous area classification.</li> </ul>

No.: 2		Lower Bunker Station								
Item	Deviation	Causes	Consequences	Matrix	Severity	Likelihood	Risk	Safeguards	Recommendations	Comment
								6. Hydrogen, Fire & Gas (F&G) Detection System monitoring H <sub>2</sub> storage area & bunkering station 7. Monitoring crew to manually initiate emergency system shutdown by activating ESD push buttons in case of emergency 8. Crew is equipped with Personnel Protective Equipment (PPE) 9. Bunkering crew is equipped with portable gas detectors 10. Door towards main deck gas tight and close	106. Conduct Fire Hazards Analysis, Gas Dispersion Analysis, Explosion Analysis to establish hazardous area zones and hazardous impact. Provide appropriate mitigations for fire and explosion consequences. Evaluate if the vessel structural damage due to explosion can compromise the damage stability and integrity of the vessel. Evaluate the vent mast design and hazardous area zone established by the vent mast.	
			2. H <sub>2</sub> migration to safe space of main deck from side shell opening (i.e. supply vents)	Asset	2	C	Moderate			
			3. Personnel exposure to H <sub>2</sub> (low likelihood, due to area restriction)	Injury	4	A	High			
2.3	Entry to Lower Bunker Station	1. H <sub>2</sub> gas leak & migration to surrounding area	1. H <sub>2</sub> migration into vehicle deck & extension of hazardous area	Asset	2	C	Moderate	1. Proper manufacturing, system testing, and leak testing of H <sub>2</sub> piping, storage tank, system	22. Develop detailed hazardous area drawing and provide air locks if required for the Lower Bunkering Station. 107. Develop procedure and training for entry to lower bunker area	

No.: 2		Lower Bunker Station								
Item	Deviation	Causes	Consequences	Matrix	Severity	Likelihood	Risk	Safeguards	Recommendations	Comment
								2. Bunker station, H <sub>2</sub> storage area, and tank connection space are classified and restricted (minimizing personnel exposure in case of emergency and restricted access during bunkering) 3. Bunkering procedures include thermal image scan for hot spots or overheating before starting, equalizing the bunker lines to bunkering pressure from bunker vessel (250 bar max), and leak testing, and opening the H <sub>2</sub> storage tank valve 4. System design such that H <sub>2</sub> volume is very low in the line, minimizing the severity of release 5. System design such that all piping is welded with no joints or connections (minimizing H <sub>2</sub> leakages) 6. Crew continuously monitoring the bunkering operation from a safe area 7. Hydrogen, Fire & Gas (F&G) Detection System monitoring H <sub>2</sub> storage area & bunkering station		

No.: 2		Lower Bunker Station								
Item	Deviation	Causes	Consequences	Matrix	Severity	Likelihood	Risk	Safeguards	Recommendations	Comment
								8. Pressure transmitters to monitor H <sub>2</sub> piping and piping annulus space (N <sub>2</sub> ) 9. Emergency Shutdown System (ESD) of H <sub>2</sub> storage system & bunkering station 10. Monitoring crew to manually initiate emergency system shutdown by activating ESD push buttons in case of emergency 11. Blowdown of H <sub>2</sub> inventory in H <sub>2</sub> storage tanks & piping 12. Firefighting system: activation of water sprays in case of fire onboard 13. Crew is equipped with Personnel Protective Equipment (PPE) 14. Bunkering crew is equipped with portable gas detectors		
			2. H <sub>2</sub> accumulation in void space	Asset	2	C	Moderate			
			3. Jet fire	Overall	S4-Major	LB-Unlikely	High			
			4. Explosion	Overall	S4-Major	LB-Unlikely	High			

No.: 2		Lower Bunker Station								
Item	Deviation	Causes	Consequences	Matrix	Severity	Likelihood	Risk	Safeguards	Recommendations	Comment
2.4	Leakage upstream of ESDV-002 valve (i.e. flange connections, QCDC connections, hose) in Lower Bunker Station	1. Leakage from flange connections, QCDC connections, hose due to improper connections, corrosions, wear and tear, vibration etc.	1. H <sub>2</sub> leakage in lower bunker station area and migration to top deck	Asset	2	C	Moderate	1. Exclusion zone to keep personnel away from bunkering area (only bunkering crew in area during bunkering) 2. Proper manufacturing, system testing, and leak testing of H <sub>2</sub> piping, storage tank, system 3. Bunker station, H <sub>2</sub> storage area, and tank connection space are classified and restricted (minimizing personnel exposure in case of emergency and restricted access during bunkering) 4. Bunkering procedures include thermal image scan for hot spots or overheating before starting, equalizing the bunker lines to bunkering pressure from bunker vessel (250 bar max), and leak testing, and opening the H <sub>2</sub> storage tank valve 5. System design such that all piping is welded with no joints or connections (minimizing H <sub>2</sub> leakages)	1. Conduct Fire Hazards Analysis, Gas Dispersion Analysis, Explosion Analysis to establish hazardous area zones and hazardous impact. Provide appropriate mitigations for fire and explosion consequences. Evaluate if the vessel structural damage due to explosion can compromise the damage stability and integrity of the vessel. Evaluate the vent mast design and hazardous area zone established by the vent mast. 2. Install permanent H <sub>2</sub> gas detectors around the lower bunkering station to provide alarms/shutdown in case of H <sub>2</sub> leak or fire. 4. Electrical groundings are to be provided for both shore and ship bunkering. 10. Per IGF Code, add automatic and manual isolation valves to the bunker manifold. Current design only shows one automatic shutdown valve.	- Both Bunkering station arrangements are open, will be used based on bunker infrastructure on land or on bunker vessel. - double walled piping extends inside the duct - cascade bunkering procedures - bunkering controls will be done from control station in each bunker station (away from the wheelhouse) and also duplicated onshore - vessel bunkering crew operating nearby in control station near each bunker station - preliminary fire hazard analysis establish expected jet fire size based on various factors - bunkering expected to last 30 mins

No.: 2		Lower Bunker Station								
Item	Deviation	Causes	Consequences	Matrix	Severity	Likelihood	Risk	Safeguards	Recommendations	Comment
								6. Crew continuously monitoring the bunkering operation from a safe area 7. Hydrogen, Fire & Gas (F&G) Detection System monitoring H <sub>2</sub> storage area & bunkering station 8. Pressure transmitters to monitor H <sub>2</sub> piping and piping annulus space (N <sub>2</sub> ) 9. Emergency Shutdown System (ESD) of H <sub>2</sub> storage system & bunkering station. 10. Monitoring crew to manually initiate emergency system shutdown by activating ESD push buttons in case of emergency 12. Firefighting system: activation of water sprays in case of fire onboard, fire hose near bunker stations 13. Crew is equipped with Personnel Protective Equipment (PPE) 14. Bunkering crew is equipped with portable gas detectors 15. Ship-to-Shore connections for ESD functions		

No.: 2		Lower Bunker Station								
Item	Deviation	Causes	Consequences	Matrix	Severity	Likelihood	Risk	Safeguards	Recommendations	Comment
								16. No side opening in hull above lower bunker station except bunker door 17. Ship/shore ESD link		
			3. Personnel injury due to H <sub>2</sub> exposure (vessel bunkering crew operating nearby in control station near each bunker station)	Injury	4	B	High			
			4. Jet fire or flash fire	Overall	S4-Major	LB-Unlikely	High			
		2. Bunker hose failure due to fatigue, improper design/maintenance, etc.	2. H <sub>2</sub> leakage from Bunker Hose	Asset	2	C	Moderate	1. Exclusion zone to keep personnel away from bunkering area (only bunkering crew in area during bunkering) 2. Proper manufacturing, system testing, and leak testing of H <sub>2</sub> piping, storage tank, system 3. Bunker station, H <sub>2</sub> storage area, and tank connection space are classified and restricted (minimizing personnel exposure in case of emergency and restricted access during bunkering)	1. Conduct Fire Hazards Analysis, Gas Dispersion Analysis, Explosion Analysis to establish hazardous area zones and hazardous impact. Provide appropriate mitigations for fire and explosion consequences. Evaluate if the vessel structural damage due to explosion can compromise the damage stability and integrity of the vessel. Evaluate the vent mast design and hazardous area zone established by the vent mast. 2. Install permanent H <sub>2</sub> gas detectors around the lower bunkering station to provide alarms/shutdown in case of H <sub>2</sub> leak or fire.	

No.: 2		Lower Bunker Station								
Item	Deviation	Causes	Consequences	Matrix	Severity	Likelihood	Risk	Safeguards	Recommendations	Comment
								4. Bunkering procedures include thermal image scan for hot spots or overheating before starting, equalizing the bunker lines to bunkering pressure from bunker vessel (250 bar max), and leak testing, and opening the H <sub>2</sub> storage tank valve 5. System design such that all piping is welded with no joints or connections (minimizing H <sub>2</sub> leakages) 6. Crew continuously monitoring the bunkering operation from a safe area 7. Hydrogen, Fire & Gas (F&G) Detection System monitoring H <sub>2</sub> storage area & bunkering station 8. Pressure transmitters to monitor H <sub>2</sub> piping and piping annulus space (N <sub>2</sub> ) 9. Emergency Shutdown System (ESD) of H <sub>2</sub> storage system & bunkering station.	4. Electrical groundings are to be provided for both shore and ship bunkering.	



No.: 2		Lower Bunker Station								
Item	Deviation	Causes	Consequences	Matrix	Severity	Likelihood	Risk	Safeguards	Recommendations	Comment
								10. Monitoring crew to manually initiate emergency system shutdown by activating ESD push buttons in case of emergency 11. Pressure Relief System (PSV 21-PR-02) on the H <sub>2</sub> bunker line to relieve pressure 12. Firefighting system: activation of water sprays in case of fire onboard, fire hose near bunker stations 13. Crew is equipped with Personnel Protective Equipment (PPE) 14. Bunkering crew is equipped with portable gas detectors 15. Ship-to-Shore connections for ESD functions 16. No side opening in hull above lower bunker station except bunker door 17. Ship/shore ESD link		
			3. Personnel injury due to H <sub>2</sub> exposure (vessel bunkering crew operating nearby in control station near each bunker station)	Injury	4	B	High			
			4. Jet fire or flash fire	Overall	S4-Major	LB-Unlikely	High			

No.: 2		Lower Bunker Station								
Item	Deviation	Causes	Consequences	Matrix	Severity	Likelihood	Risk	Safeguards	Recommendations	Comment
2.5	Leakage downstream of ESDV-002 valve in Lower Bunker Station	1. Leakage from flange connections, corrosions, wear and tear, vibration, mechanical damage, valve gland, seals, etc.	1. H <sub>2</sub> leakage at inside lower bunker station	Asset	2	C	Moderate	1. Proper manufacturing, system testing, and leak testing of H <sub>2</sub> piping, storage tank, system 2. Bunker station, H <sub>2</sub> storage area, and tank connection space are classified and restricted (minimizing personnel exposure in case of emergency and restricted access during bunkering) 3. Bunkering procedures include thermal image scan for hot spots or overheating before starting, equalizing the bunker lines to bunkering pressure from bunker vessel (250 bar max), and leak testing, and opening the H <sub>2</sub> storage tank valve 4. System design such that all piping is welded with no joints or connections (minimizing H <sub>2</sub> leakages) 5. Crew continuously monitoring the bunkering operation from a safe area	1. Conduct Fire Hazards Analysis, Gas Dispersion Analysis, Explosion Analysis to establish hazardous area zones and hazardous impact. Provide appropriate mitigations for fire and explosion consequences. Evaluate if the vessel structural damage due to explosion can compromise the damage stability and integrity of the vessel. Evaluate the vent mast design and hazardous area zone established by the vent mast. 2. Install permanent H <sub>2</sub> gas detectors around the lower bunkering station to provide alarms/shutdown in case of H <sub>2</sub> leak or fire. 5. Develop bunkering procedures including the bunkering pressure and temperature in the H <sub>2</sub> storage tank to stay within tank design limits. Also, develop bunkering restrictions to avoid bunkering during adverse weather (rain, lightning, etc.) which can lead to connections overload, gas leakage, etc.	- tank failure mode due to temperature to be discussed

No.: 2		Lower Bunker Station								
Item	Deviation	Causes	Consequences	Matrix	Severity	Likelihood	Risk	Safeguards	Recommendations	Comment
								6. Hydrogen, Fire & Gas (F&G) Detection System monitoring H <sub>2</sub> storage area & bunkering station 7. Pressure transmitters to monitor H <sub>2</sub> piping and piping annulus space (N <sub>2</sub> ) 8. Emergency Shutdown System (ESD) of H <sub>2</sub> storage system & bunkering station. 9. Monitoring crew to manually initiate emergency system shutdown by activating ESD push buttons in case of emergency 10. Pressure Relief System (PSV 21-PR-02) on the H <sub>2</sub> bunker line to relieve pressure 11. Firefighting system: activation of water sprays in case of fire onboard, fire hose near bunker stations 12. Crew is equipped with Personnel Protective Equipment (PPE) 13. Bunkering crew is equipped with portable gas detectors	94. After connections bunker lines pressure testing proper tightness/leak testing to be performed. e.g., with helium or 5% H <sub>2</sub> /N <sub>2</sub>	

No.: 2		Lower Bunker Station								
Item	Deviation	Causes	Consequences	Matrix	Severity	Likelihood	Risk	Safeguards	Recommendations	Comment
								14. Ship-to-Shore connections for ESD functions 15. ESD and blowdown upon detection of gas		
			2. Personnel injury due to H <sub>2</sub> exposure (vessel bunkering crew operating nearby in control station near each bunker station)	Injury	4	B	High			
			3. Jet fire or flash fire	Overall	S4-Major	LB-Unlikely	High			
		2. Bunker hose failure due to fatigue, improper design/maintenance, etc.	1. H <sub>2</sub> leakage at inside lower bunker station	Asset	2	C	Moderate	1. Proper manufacturing, system testing, and leak testing of H <sub>2</sub> piping, storage tank, system 2. Bunker station, H <sub>2</sub> storage area, and tank connection space are classified and restricted (minimizing personnel exposure in case of emergency and restricted access during bunkering) 3. Bunkering procedures include thermal image scan for hot spots or overheating before starting, equalizing the bunker lines to bunkering pressure from bunker vessel (250 bar max), and leak testing, and opening the H <sub>2</sub> storage tank valve	1. Conduct Fire Hazards Analysis, Gas Dispersion Analysis, Explosion Analysis to establish hazardous area zones and hazardous impact. Provide appropriate mitigations for fire and explosion consequences. Evaluate if the vessel structural damage due to explosion can compromise the damage stability and integrity of the vessel. Evaluate the vent mast design and hazardous area zone established by the vent mast. 2. Install permanent H <sub>2</sub> gas detectors around the lower bunkering station to provide alarms/shutdown in case of H <sub>2</sub> leak or fire.	

No.: 2		Lower Bunker Station								
Item	Deviation	Causes	Consequences	Matrix	Severity	Likelihood	Risk	Safeguards	Recommendations	Comment
								4. System design such that all piping is welded with no joints or connections (minimizing H <sub>2</sub> leakages) 5. Crew continuously monitoring the bunkering operation from a safe area 6. Hydrogen, Fire & Gas (F&G) Detection System monitoring H <sub>2</sub> storage area & bunkering station 7. Pressure transmitters to monitor H <sub>2</sub> piping and piping annulus space (N <sub>2</sub> ) 8. Emergency Shutdown System (ESD) of H <sub>2</sub> storage system & bunkering station. 9. Monitoring crew to manually initiate emergency system shutdown by activating ESD push buttons in case of emergency 10. Pressure Relief System (PSV 21-PR-02) on the H <sub>2</sub> bunker line to relieve pressure 11. Firefighting system: activation of water sprays in case of fire onboard, fire hose near bunker stations	5. Develop bunkering procedures including the bunkering pressure and temperature in the H <sub>2</sub> storage tank to stay within tank design limits. Also, develop bunkering restrictions to avoid bunkering during adverse weather (rain, lightning, etc.) which can lead to connections overload, gas leakage, etc.	

No.: 2		Lower Bunker Station								
Item	Deviation	Causes	Consequences	Matrix	Severity	Likelihood	Risk	Safeguards	Recommendations	Comment
								12. Crew is equipped with Personnel Protective Equipment (PPE) 13. Bunkering crew is equipped with portable gas detectors 14. Ship-to-Shore connections for ESD functions		
			2. Personnel injury due to H <sub>2</sub> exposure (vessel bunkering crew operating nearby in control station near each bunker station)	Injury	4	B	High			
			3. Jet fire or flash fire	Overall	S4-Major	LB-Unlikely	High			
2.6	H <sub>2</sub> leakage inside void space where the bunker line is passing	1. H <sub>2</sub> leakage inside void space	1. H <sub>2</sub> accumulation in void space	Asset	2	B	Low	1. Proper manufacturing, system testing, and leak testing of H <sub>2</sub> piping, storage tank, system 2. Bunker station, H <sub>2</sub> storage area, and tank connection space are classified and restricted (minimizing personnel exposure in case of emergency and restricted access during bunkering)	23. Consider adding double wall piping for the bunker line passing through void spaces at the Lower Bunker Station. 24. Consider running the bunker line for Lower Bunkering Station so the line is not in the damage penetration zone established by regulations. 25. Conduct operational HAZID when bunkering procedures when detail designs are available.	- piping from bunker station to H <sub>2</sub> storage tanks on wheelhouse deck is double walled.

No.: 2		Lower Bunker Station								
Item	Deviation	Causes	Consequences	Matrix	Severity	Likelihood	Risk	Safeguards	Recommendations	Comment
								3. Bunkering procedures include thermal image scan for hot spots or overheating before starting, equalizing the bunker lines to bunkering pressure from bunker vessel (250 bar max), and leak testing, and opening the H <sub>2</sub> storage tank valve 4. System design such that H <sub>2</sub> volume is very low in the line, minimizing the severity of release 5. System design such that all piping is welded with no joints or connections (minimizing H <sub>2</sub> leakages) 6. Crew continuously monitoring the bunkering operation from a safe area 7. Oxygen detector AQA-005 to provide alarm (L) and shutdown (LL) 8. Hydrogen, Fire & Gas (F&G) Detection System monitoring H <sub>2</sub> storage area & bunkering station 9. Pressure transmitters to monitor H <sub>2</sub> piping and piping annulus space (N <sub>2</sub> )		

No.: 2		Lower Bunker Station								
Item	Deviation	Causes	Consequences	Matrix	Severity	Likelihood	Risk	Safeguards	Recommendations	Comment
								10. Temperature transmitters TT-001 to monitor temperature at the bunkering station and provide alarms (H, L) and shutdown (HH) 11. Emergency Shutdown System (ESD) of H <sub>2</sub> storage system & bunkering station 12. Monitoring crew to manually initiate emergency system shutdown by activating ESD push buttons in case of emergency 13. Blowdown of H <sub>2</sub> inventory in H <sub>2</sub> storage tanks & piping 14. Pressure Relief System (PSV 21-PR-02) on the H <sub>2</sub> bunker line to relieve pressure 15. Firefighting system: activation of water sprays in case of fire onboard 16. Crew is equipped with Personnel Protective Equipment (PPE) 17. Bunkering crew is equipped with portable gas detectors		
			2. Jet Fire	Overall	S4-Major	LB-Unlikely	High			



<b>No.: 2</b>		Lower Bunker Station								
<b>Item</b>	<b>Deviation</b>	<b>Causes</b>	<b>Consequences</b>	<b>Matrix</b>	<b>Severity</b>	<b>Likelihood</b>	<b>Risk</b>	<b>Safeguards</b>	<b>Recommendations</b>	<b>Comment</b>
			3. Explosion / structural damage	Overall	S4-Major	LA-Rare	High			

3	Vessel General Arrangement
<p>Section notes: HYSEAS III</p> <ul style="list-style-type: none"> <li>- double ended ferry</li> <li>- external H<sub>2</sub> storage (gas)</li> <li>- H<sub>2</sub> fuel cell providing main propulsion</li> <li>- CMAL started project in 2020</li> <li>- domestic EU class C passenger vehicle (no requirement for safe port return)</li> </ul> <p>General Arrangement:</p> <ul style="list-style-type: none"> <li>- 2 battery rooms</li> <li>- Fuel Cell Room is not designated as hazardous area</li> <li>- port side: H<sub>2</sub> infrastructures, starboard side: passenger area</li> <li>- blast wall/ blast load to prevent H<sub>2</sub> dispersion to starboard side (from Gas Dispersion Analysis, worst case cloud extends to level below where heavy goods vehicles are located), covering 2 sides</li> <li>- Dropped Objects projection: grid structure/protection around the H<sub>2</sub> tanks to minimise dropped objects impact but not impeding the H<sub>2</sub> ventilation</li> <li>- 3 life rafts onboard</li> <li>- pressure reducing station also located on open deck, to avoid high pressure piping in enclosed spaces and minimizing leak potential in enclosed spaces</li> <li>- vent mast: vent manifold from relief from H<sub>2</sub> bottles, purging of H<sub>2</sub> pipes, etc.</li> <li>- Fuel Cell ventilation: type approval does not consider this is to hazardous, so venting is to open deck.</li> <li>- Battery System ventilation: considered hazardous area with local vents in battery room, which vents to is to open deck.</li> <li>- Emergency Generator: details TBD. In case of loss of primary propulsion power, Li-ion battery system can provide power for ferry to return to port (without the need for emergency generator)</li> </ul>	

<b>No.: 3</b>		Vessel General Arrangement								
Item	Deviation	Causes	Consequences	Matrix	Severity	Likelihood	Risk	Safeguards	Recommendations	Comment
3.1	No additional risk identified. Other nodes identify GA related risk									

4	<p>H<sub>2</sub> Storage System Location on Wheelhouse Deck (open) (Tanks, Tank Interface, Supports)</p> <ul style="list-style-type: none"> <li>- H<sub>2</sub> tank to be replaced every 30 years during the life span of the ferry</li> <li>- during idle period, internal hydrogen storage space still need to be inerted</li> <li>- assumes H<sub>2</sub> storage tank meet ISO standards</li> </ul> <p>H<sub>2</sub> Storage System Location on Wheelhouse Deck (open):</p> <ul style="list-style-type: none"> <li>- leakage dissipates relatively quickly (based on preliminary Gas Dispersion Analysis)</li> <li>- easier to maintain and access</li> <li>- reduces double wall piping requirements</li> <li>- keeps HP system out of enclosed spaces, except lower bunker station and manifold lines</li> <li>- more space available to optimise arrangement</li> <li>- easier to construct</li> </ul> <p>Gas Bottles inside H<sub>2</sub> Storage:</p> <ul style="list-style-type: none"> <li>- insufficient height in current arrangement (storage location II) to stack the tanks 2 high -&gt; potential inspection/maintenance issues, congestion level leading to likelihood of peak pressures</li> </ul> <p>IGF code regulation:</p> <p>6.7.1.1 All fuel storage tanks shall be provided with a pressure relief system appropriate to the design of the fuel containment system and the fuel being carried. Fuel storage hold spaces, inter barrier spaces, tank connection spaces and tank coffer dams, which may be subject to pressures beyond their design capabilities, shall also be provided with a suitable pressure relief system. Pressure control systems specified in 6.9 shall be independent of the pressure relief systems.</p> <p>6.11 Regulations on atmosphere control within fuel storage hold spaces (Fuel containment systems other than type C independent tanks)</p> <p>6.11.1 Inter barrier and fuel storage hold spaces associated with liquefied gas fuel containment systems requiring full or partial secondary barriers shall be inerted with a suitable dry inert gas and kept inerted with makeup gas provided by a shipboard inert gas generation system, or by shipboard storage, which shall be sufficient for normal consumption for at least 30 days. Shorter periods may be considered by the Administration depending on the ship's service.</p> <p>6.11.2 Alternatively, the spaces referred to in 6.11.1 requiring only a partial secondary barrier may be filled with dry air provided that the ship maintains a stored charge of inert gas or is fitted with an inert gas generation system sufficient to inert the largest of these spaces, and provided that the configuration of the spaces and the relevant vapour detection systems, together with the capability of the inerting arrangements, ensures that any leakage from the liquefied gas fuel tanks will be rapidly detected and inerting effected before a dangerous condition can develop. Equipment for the provision of sufficient dry air of suitable quality to satisfy the expected demand shall be provided.</p> <p>6.12 Regulations on environmental control of spaces surrounding type C independent tanks</p> <p>6.12.1 Spaces surrounding liquefied gas fuel tanks shall be filled with suitable dry air and be maintained in this condition with dry air provided by suitable air-drying equipment. This is only applicable for liquefied gas fuel tanks where condensation and icing due to cold surfaces is an issue.</p> <p>Applicable IGF requirements:</p> <p>9.4 Regulations on safety functions of gas supply system</p> <p>9.4.1 Fuel storage tank inlets and outlets shall be provided with valves located as close to the tank as possible. Valves required to be operated during normal operation* which are not accessible shall be remotely operated. Tank valves whether accessible or not shall be automatically operated when the safety system required in 15.2.2 is activated.</p> <p>* Normal operation in this context is when gas is supplied to consumers and during bunkering operations.</p> <p>9.4.2 The main gas supply line to each gas consumer or set of consumers shall be equipped with a manually operated stop valve and an automatically operated ?master gas fuel valve? coupled in series or a combined manually and automatically operated valve. The valves shall be situated in the part of the piping that is outside the machinery space containing gas consumers and placed as</p>
---	---

near as possible to the installation for heating the gas, if fitted. The master gas fuel valve shall automatically cut off the gas supply when activated by the safety system required in 15.2.2.

9.4.8 There shall be one manually operated shutdown valve in the gas supply line to each engine upstream of the double block and bleed valves to assure safe isolation during maintenance on the engine.

No.: 4		H <sub>2</sub> Storage System Location on Wheelhouse Deck (open) (Tanks, Tank Interface, Supports)								
Item	Deviation	Causes	Consequences	Matrix	Severity	Likelihood	Risk	Safeguards	Recommendations	Comment
4.1	H <sub>2</sub> leakage upstream of ESDVs to H <sub>2</sub> storage tanks	1. Threaded connection leaks, vibration, fatigue failure, corrosion <b>Comment:</b> - leaks from connections near the H <sub>2</sub> storage tank can lead to jet fire impinging on the H <sub>2</sub> storage tank or a surrounding H <sub>2</sub> tank. - threaded connections can lead to higher likelihood of leaks comparing to welded connections.	1. H <sub>2</sub> release from connections upstream of ESDVs (individual H <sub>2</sub> storage tank)	Asset	2	C	Moderate	1. Proper manufacturing , system testing, and leak testing of H <sub>2</sub> piping, storage tank, system 2. A60 insulation below the H <sub>2</sub> storage area (bridge deck) & on the main deck (underneath) 3. Blast wall separating the wheelhouse from H <sub>2</sub> storage area * 4. System design such that all piping is welded with no joints or connections (minimizing H <sub>2</sub> leakages)	26. Proper selection of thermal protections to be provided considering the sensitivity of H <sub>2</sub> storage tank due to thermal impact or jet fire impingement or alternate arrangement to avoid jet impingement. 27. Consider the design and arrangements of H <sub>2</sub> storage tanks to avoid any jet fire impingement on the tank due to connection leakage. 28. Evaluate the effectiveness of F&G Detection in the H <sub>2</sub> storage area when the location is open on the wheelhouse deck. 29. Study the leak detection mechanisms to provide early leakage detection in case of leaks from H <sub>2</sub> storage tanks. 30. Investigate mechanisms for H <sub>2</sub> storage tank monitoring system (i.e. volume %) and programmable control logic to provide early leak detection from a H <sub>2</sub> tank. 31. Develop firefighting philosophy including F&G detection, surface temperature detection, shutdown & blowdown initiation, and cooling of H <sub>2</sub> tanks in case of fire.	- ESDVs: ESDV-003 to ESDV-013 are automatic valves, rated for hazardous zone, and located close to the tanks - piping and connections located in front of the tanks (tanks stacked)

No.: 4		H <sub>2</sub> Storage System Location on Wheelhouse Deck (open) (Tanks, Tank Interface, Supports)								
Item	Deviation	Causes	Consequences	Matrix	Severity	Likelihood	Risk	Safeguards	Recommendations	Comment
								5. Hydrogen, Fire & Gas (F&G) Detection System monitoring H <sub>2</sub> storage area & bunkering station 6. Pressure transmitters to monitor H <sub>2</sub> piping and tank pressure 7. H <sub>2</sub> leak detection from H <sub>2</sub> storage tank and piping will initiate alarms for operator response and activate ESD system 8. Emergency Shutdown System (ESD) of H <sub>2</sub> storage system & bunkering station 9. Blowdown of H <sub>2</sub> inventory in H <sub>2</sub> storage tanks & piping 10. Pressure Relief Valves on H <sub>2</sub> Storage Tank	32. Evaluate the surface temperature detection philosophy and its interaction with other tank protection mechanisms in case of fire impacting the H <sub>2</sub> storage tank. 33. Investigate the effectiveness of the water spray system such as nozzle arrangement, coverage zone, etc. in case of H <sub>2</sub> storage tank fire. Consider the potential for the water spray system activation to compromise the effectiveness of the H <sub>2</sub> tank thermal protection (i.e., thermal pressure relief device (TPRD)). 65. Develop periodic inspections and test plans for the H <sub>2</sub> piping to detect inner wall and outer wall damage. Piping connections are to be checked periodically to identify potential leak points. 108. Proper study to be conducted for fume management and further risk evaluated e.g., using single tank, group of tank or all the tank same time loading/usage etc. 109. Consider tank support and deck structure to withstand blast load. Calculation to be done for fire and blast load.	

No.: 4		H <sub>2</sub> Storage System Location on Wheelhouse Deck (open) (Tanks, Tank Interface, Supports)								
Item	Deviation	Causes	Consequences	Matrix	Severity	Likelihood	Risk	Safeguards	Recommendations	Comment
								11. Firefighting system: activation of water sprays in case of fire onboard 12. Crew is equipped with Personnel Protective Equipment (PPE) 13. Bunkering crew is equipped with portable gas detectors 14. Li-ion battery power available to finish voyage 15. Detail FMECA to be conducted for tank and manifold piping and its control.		
			2. Jet fire impinging on H <sub>2</sub> tank or surrounding tank	Overall	S4-Major	LC-Possible	Extreme			
			3. Explosion - damage to deck structure, manifold damage, fuel tank damage etc.	Overall	S4-Major	LC-Possible	Extreme			

No.: 4		H <sub>2</sub> Storage System Location on Wheelhouse Deck (open) (Tanks, Tank Interface, Supports)								
Item	Deviation	Causes	Consequences	Matrix	Severity	Likelihood	Risk	Safeguards	Recommendations	Comment
			6. Loss of H <sub>2</sub> supply to Fuel Cell	Asset	2	C	Moderate			
4.2	H <sub>2</sub> leakage downstream of ESDVs to Pressure reduction valves	1. Connection leaks, vibration, fatigue failure, corrosion	1. H <sub>2</sub> release	Asset	2	B	Low	1. Proper manufacturing, system testing, and leak testing of H <sub>2</sub> piping, storage tank, system 2. A60 insulation below the H <sub>2</sub> storage area (bridge deck) & on the main deck (underneath) 3. System design such that all piping is welded with no joints or connections (minimizing H <sub>2</sub> leakages) 4. Hydrogen, Fire & Gas (F&G) Detection System monitoring H <sub>2</sub> storage area & bunkering station 5. Pressure transmitters to monitor H <sub>2</sub> piping and CCPV tank	28. Evaluate the effectiveness of F&G Detection in the H <sub>2</sub> storage area when the location is open on the wheelhouse deck. 29. Study the leak detection mechanisms to provide early leakage detection in case of leaks from H <sub>2</sub> storage tanks. 30. Investigate mechanisms for H <sub>2</sub> storage tank monitoring system (i.e., volume %) and programmable control logic to provide early leak detection from a H <sub>2</sub> tank. 31. Develop firefighting philosophy including F&G detection, surface temperature detection, shutdown & blowdown initiation, and cooling of H <sub>2</sub> tanks in case of fire. 33. Investigate the effectiveness of the water spray system such as nozzle arrangement, coverage zone, etc. in case of H <sub>2</sub> storage tank fire. Consider the potential for the water spray system activation to compromise the effectiveness of the H <sub>2</sub> tank thermal protection (i.e., thermal pressure relief device (TPRD)).	- ESDVs will be located close to the H <sub>2</sub> storage tanks - ESDVs are fail closed automatic valves - before ESDV-014 master H <sub>2</sub> supply valve to fuel cell system

No.: 4		H <sub>2</sub> Storage System Location on Wheelhouse Deck (open) (Tanks, Tank Interface, Supports)								
Item	Deviation	Causes	Consequences	Matrix	Severity	Likelihood	Risk	Safeguards	Recommendations	Comment
							High	6. H <sub>2</sub> leak detection from H <sub>2</sub> storage tank and piping will initiate alarms for operator response and activate ESD system 7. Emergency Shutdown System (ESD) of H <sub>2</sub> storage system upon gas /leak detection 8. Blowdown of H <sub>2</sub> inventory in H <sub>2</sub> storage tanks & piping 10. Firefighting system: activation of water sprays in case of fire onboard 11. Crew is equipped with Personnel Protective Equipment (PPE) 12. Li-ion battery power available to finish voyage		
			2. Jet fire	Overall	S4-Major	LB-Unlikely	High			



No.: 4		H <sub>2</sub> Storage System Location on Wheelhouse Deck (open) (Tanks, Tank Interface, Supports)								
Item	Deviation	Causes	Consequences	Matrix	Severity	Likelihood	Risk	Safeguards	Recommendations	Comment
			3. High temperature in H <sub>2</sub> storage system - H <sub>2</sub> Storage System Location Below Deck (Tanks, Tank Interface, Supports) (linked to 5.5)							
			4. System shutdown, loss of fuel to fuel cell, loss of propulsion	Asset	2	C	Moderate			
4.3	Fire from main deck (vehicle fire)	1. Vehicle fire from main deck	1. High temperature on H <sub>2</sub> storage area on bridge deck	Asset	2	C	Moderate	2. Blast wall separating the wheelhouse from H <sub>2</sub> storage area 3. A60 insulation below the H <sub>2</sub> storage area (bridge deck) & on the main deck (underneath) 6. Pressure transmitters at each H <sub>2</sub> Storage Tank to provide alarms (L, H) and shutdowns (HH)	1. Conduct Fire Hazards Analysis, Gas Dispersion Analysis, Explosion Analysis to establish hazardous area zones and hazardous impact. Provide appropriate mitigations for fire and explosion consequences. Evaluate if the vessel structural damage due to explosion can compromise the damage stability and integrity of the vessel. Evaluate the vent mast design and hazardous area zone established by the vent mast.	

No.: 4		H <sub>2</sub> Storage System Location on Wheelhouse Deck (open) (Tanks, Tank Interface, Supports)								
Item	Deviation	Causes	Consequences	Matrix	Severity	Likelihood	Risk	Safeguards	Recommendations	Comment
								7. Temperature transmitters at each H <sub>2</sub> Storage Tank to provide alarms (L, H) and shutdowns (HH) 8. Emergency Shutdown System (ESD) of H <sub>2</sub> storage system & bunkering station 9. Blowdown of H <sub>2</sub> inventory in H <sub>2</sub> storage tanks & piping 10. Pressure Relief Valves on H <sub>2</sub> Storage Tank 11. Firefighting system initiate to fight vehicle fire on the main deck 12. Crew is equipped with Personnel Protective Equipment (PPE) 13. Spray water system for H <sub>2</sub> tank and piping on bridge deck		

No.: 4		H <sub>2</sub> Storage System Location on Wheelhouse Deck (open) (Tanks, Tank Interface, Supports)								
Item	Deviation	Causes	Consequences	Matrix	Severity	Likelihood	Risk	Safeguards	Recommendations	Comment
								14. Blowdown of tank if needed		
			2. H <sub>2</sub> storage tank integrity compromised	Asset	2	C	Moderate			
			3. Increase internal pressure in H <sub>2</sub> tank due to heat gain	Asset	3	B	Moderate			
			4. Damage to tank and Explosion	Overall	S4-Major	LB-Unlikely	High			
4.4	Fire from crew mess	1. Equipment fire from crew mess	1. High temperature on H <sub>2</sub> storage area on bridge deck	Asset	2	C	Moderate	1. Proper manufacturing , system testing, and leak testing of H <sub>2</sub> piping, storage tank, system 2. Blast wall separating the wheelhouse from H <sub>2</sub> storage area 3. A60 insulation below the H <sub>2</sub> storage area (bridge deck) & on the main deck (underneath)		

No.: 4		H <sub>2</sub> Storage System Location on Wheelhouse Deck (open) (Tanks, Tank Interface, Supports)								
Item	Deviation	Causes	Consequences	Matrix	Severity	Likelihood	Risk	Safeguards	Recommendations	Comment
								4. Hydrogen, Fire & Gas (F&G) Detection System monitoring H <sub>2</sub> storage area & bunkering station 5. H <sub>2</sub> leak detection from H <sub>2</sub> storage tank and piping will initiate alarms for operator response and activate ESD system 6. Pressure transmitters at each H <sub>2</sub> Storage Tank to provide alarms (L, H) and shutdowns (HH) 7. Temperature transmitters at each H <sub>2</sub> Storage Tank to provide alarms (L, H) and shutdowns (HH)		

No.: 4		H <sub>2</sub> Storage System Location on Wheelhouse Deck (open) (Tanks, Tank Interface, Supports)								
Item	Deviation	Causes	Consequences	Matrix	Severity	Likelihood	Risk	Safeguards	Recommendations	Comment
								8. Emergency Shutdown System (ESD) of H <sub>2</sub> storage system & bunkering station 9. Blowdown of H <sub>2</sub> inventory in H <sub>2</sub> storage tanks & piping 10. Pressure Relief Valves on H <sub>2</sub> Storage Tank 11. Firefighting system initiate to fight vehicle fire on the main deck 12. Crew is equipped with Personnel Protective Equipment (PPE)		
			2. H <sub>2</sub> storage tank integrity compromised	Asset	2	C	Moderate			
			3. Increase internal pressure in H <sub>2</sub> tank due to heat gain	Asset	3	B	Moderate			
			4. Explosion	Overall	S4-Major	LB-Unlikely	High			

No.: 4		H <sub>2</sub> Storage System Location on Wheelhouse Deck (open) (Tanks, Tank Interface, Supports)								
Item	Deviation	Causes	Consequences	Matrix	Severity	Likelihood	Risk	Safeguards	Recommendations	Comment
			5. High temperature in H <sub>2</sub> storage system - H <sub>2</sub> Storage System Location Below Deck (Tanks, Tank Interface, Supports) (linked to 5.5)							
4.5	Dropped objects onto H <sub>2</sub> Storage area	1. Dropped Objects	1. Damage to H <sub>2</sub> storage tanks and manifold	Asset	3	C	High	1. Lifting Plan and Procedures will ensure no overhead lifting around H <sub>2</sub> storage area 2. No overhead structures (bridges, cranes) on the designated ferry route 3. Protective framework above H <sub>2</sub> storage area (dropped objects protection) 4. Proper manufacturing, system testing, and leak testing of H <sub>2</sub> piping, storage tank, system	17. Develop operational procedures to ensure no overhead lifting when Fuel Cell system is running with H <sub>2</sub> supply and have restrictions in place to prevent dropped object impact on H <sub>2</sub> storage system, H <sub>2</sub> piping and H <sub>2</sub> bunkering lines.	

No.: 4		H <sub>2</sub> Storage System Location on Wheelhouse Deck (open) (Tanks, Tank Interface, Supports)								
Item	Deviation	Causes	Consequences	Matrix	Severity	Likelihood	Risk	Safeguards	Recommendations	Comment
								5. Blast wall separating the wheelhouse from H <sub>2</sub> storage area 6. A60 insulation below the H <sub>2</sub> storage area (bridge deck) & on the main deck (underneath) 7. Hydrogen, Fire & Gas (F&G) Detection System monitoring H <sub>2</sub> storage area & bunkering station 8. H <sub>2</sub> leak detection from H <sub>2</sub> storage tank and piping will initiate alarms for operator response and activate ESD system 9. Emergency Shutdown System (ESD) of H <sub>2</sub> storage system & bunkering station		

No.: 4		H <sub>2</sub> Storage System Location on Wheelhouse Deck (open) (Tanks, Tank Interface, Supports)								
Item	Deviation	Causes	Consequences	Matrix	Severity	Likelihood	Risk	Safeguards	Recommendations	Comment
								10. Blowdown of H <sub>2</sub> inventory in H <sub>2</sub> storage tanks & piping 11. Pressure Relief Valves on H <sub>2</sub> Storage Tank 12. Firefighting system initiate to fight vehicle fire on the main deck 13. Crew is equipped with Personnel Protective Equipment (PPE)		
			2. H <sub>2</sub> leakage	Asset	2	C	Moderate			
			3. Jet Fire & Flash Fire	Overall	S4-Major	LB-Unlikely	High			
			4. Explosion (tank disintegration)	Overall	S4-Major	LB-Unlikely	High			
4.6	Weather impact	1. Rain <b>Comment:</b> - potential rain impact on thermal pressure relief device (TPRD)	1. Compromised thermal protection (TPRD on H <sub>2</sub> storage tanks) can lead to over pressure and explosion	Asset	4	C	Extreme	6. Manual blowdown 7. Pressure and temperature monitoring	33. Investigate the effectiveness of the water spray system such as nozzle arrangement, coverage zone, etc. in case of H <sub>2</sub> storage tank fire. Consider the potential for the water spray system activation to compromise the effectiveness of the H <sub>2</sub> tank thermal protection (i.e., thermal pressure relief device (TPRD)).	- assumes H <sub>2</sub> storage tank meet ISO standards



No.: 4		H <sub>2</sub> Storage System Location on Wheelhouse Deck (open) (Tanks, Tank Interface, Supports)								
Item	Deviation	Causes	Consequences	Matrix	Severity	Likelihood	Risk	Safeguards	Recommendations	Comment
									34. H <sub>2</sub> Storage Tanks are to be designed for operation in the marine environment (Compatibility of materials with salty air) 110. Investigate rain impact on effectiveness/performance of TPRD	
		2. UV exposure	2. H <sub>2</sub> storage tank integrity compromised, tank degradation	Asset	2	C	Moderate	1. H <sub>2</sub> Storage Tanks are wrapped with UV layer protection		
		3. High Wind in local area	3. Flying debris impacting the tank	Asset	2	C	Moderate	3. Protective framework above H <sub>2</sub> storage area which also include a mesh to allow H <sub>2</sub> dispersion (protect against dropped objects, weather exposure such as hailstorm)		
		4. Lightning	4. Damage to H <sub>2</sub> storage tank & piping	Asset	3	C	High	2. Lighting protection on top of the mast		

No.: 4		H <sub>2</sub> Storage System Location on Wheelhouse Deck (open) (Tanks, Tank Interface, Supports)								
Item	Deviation	Causes	Consequences	Matrix	Severity	Likelihood	Risk	Safeguards	Recommendations	Comment
		5. Hailstorm	4. Damage to H <sub>2</sub> storage tank & piping	Asset	3	C	High	3. Protective framework above H <sub>2</sub> storage area which also include a mesh to allow H <sub>2</sub> dispersion (protect against dropped objects, weather exposure such as hailstorm)	35. Conduct the study on the protective framework which is to protect the H <sub>2</sub> storage tank, H <sub>2</sub> manifold, and pipe work and determine the appropriate mesh size. There is a tradeoff in terms of the framework providing protection and allowing for gas dispersion in case of H <sub>2</sub> gas leaks. Considering the area of operation and expected weather events, i.e., hailstorm and ferry travel profile.	
		6. Ice formation <b>Comment:</b> - no heat tracing - potential icing of relief valves, instrumentations, sprinkler nozzle blocked	5. Ice load on H <sub>2</sub> storage tank & piping, instrumentation, impact on relief valves	Asset	2	B	Low	4. Crew routine visual inspection of onboard system and equipment during voyage (i.e. for ice formation)	36. Study the potential for ice formation and the impact on system performance. Provide appropriate mitigations.	
			6. Water spray system not available in case of fire (ice formation on sprinkler nozzle)	Asset	3	C	High			
			9. Valve inoperable	Asset	3	C	High			
		7. Extreme marine load due to ship motion	7. Higher load on H <sub>2</sub> storage tank foundation	Asset	2	B	Low	5. H <sub>2</sub> Storage Tank foundation & support design will meet IGF code requirements	37. Determine the tank duty cycles (pressurisation & depressurisation) and ensure that tank design & testing program consider tank duty cycles for approval.	

No.: 4		H <sub>2</sub> Storage System Location on Wheelhouse Deck (open) (Tanks, Tank Interface, Supports)								
Item	Deviation	Causes	Consequences	Matrix	Severity	Likelihood	Risk	Safeguards	Recommendations	Comment
			8. Tank integrity impact, damage	Asset	3	C	High			
4.7	High pressure in H <sub>2</sub> storage system	1. Bunker system delivering at higher pressure than operating limits	1. Overpressure in H <sub>2</sub> storage tank & piping	Asset	2	C	Moderate	1. Proper manufacturing, system testing, and leak testing of H <sub>2</sub> piping, storage tank, system 2. Blast wall separating the wheelhouse from H <sub>2</sub> storage area 3. Bunker station, H <sub>2</sub> storage area, and tank connection space are classified and restricted (minimizing personnel exposure in case of emergency and restricted access during bunkering)	7. Develop proper bunkering plan considering the H <sub>2</sub> storage tank charge pressure and settle pressure considering atmospheric condition and temperature. 105. Fuel management details and procedure are to be developed per IGF code	

No.: 4		H <sub>2</sub> Storage System Location on Wheelhouse Deck (open) (Tanks, Tank Interface, Supports)								
Item	Deviation	Causes	Consequences	Matrix	Severity	Likelihood	Risk	Safeguards	Recommendations	Comment
								4. Bunkering procedures include thermal image scan for hot spots or overheating before starting, equalizing the bunker lines to bunkering pressure from bunker vessel (250 bar max), and leak testing, and opening the H <sub>2</sub> storage tank valve  5. H <sub>2</sub> Storage Tank Design such that the tank temperature & pressure operating conditions are within the design limits per tank manufacturer's specifications (i.e. 20 bar normal operating pressure)  6. H <sub>2</sub> Storage Tank Design meets ISO leak-before-failure and fatigue criteria		

No.: 4		H <sub>2</sub> Storage System Location on Wheelhouse Deck (open) (Tanks, Tank Interface, Supports)								
Item	Deviation	Causes	Consequences	Matrix	Severity	Likelihood	Risk	Safeguards	Recommendations	Comment
								7. H <sub>2</sub> Storage Tank Design meets marine loading criteria and class rules 8. H <sub>2</sub> Storage Tank Design will be tested for burst failure mode and proper fatigue life 9. H <sub>2</sub> Storage Tanks are wrapped with UV layer protection 10. Crew routine visual inspection of onboard system and equipment during voyage (i.e. for ice formation) 11. H <sub>2</sub> leak detection from H <sub>2</sub> storage tank and piping will initiate alarms for operator response and activate ESD system		

No.: 4		H <sub>2</sub> Storage System Location on Wheelhouse Deck (open) (Tanks, Tank Interface, Supports)								
Item	Deviation	Causes	Consequences	Matrix	Severity	Likelihood	Risk	Safeguards	Recommendations	Comment
								12. Pressure transmitters at each H <sub>2</sub> Storage Tank to provide alarms (L,H) and shutdowns (HH) 13. Emergency Shutdown System (ESD) of H <sub>2</sub> storage system & bunkering station 14. Blowdown of H <sub>2</sub> inventory in H <sub>2</sub> storage tanks & piping 15. Pressure Relief Valves on H <sub>2</sub> Storage Tank 16. Pressure monitoring and alarm at bunker manifold and relief valve at bunker manifold 17. Bunker operation is continuously manned and monitored		
			2. H <sub>2</sub> storage tank & piping damage	Asset	3	B	Moderate			

No.: 4		H <sub>2</sub> Storage System Location on Wheelhouse Deck (open) (Tanks, Tank Interface, Supports)								
Item	Deviation	Causes	Consequences	Matrix	Severity	Likelihood	Risk	Safeguards	Recommendations	Comment
4.8	High temperature in H <sub>2</sub> storage system	1. Bunker system delivering at higher temperature than operating limits	1. High temperature in H <sub>2</sub> storage tank & piping than allowed	Asset	2	C	Moderate	1. Bunkering procedures include thermal image scan for hot spots or overheating before starting, equalizing the bunker lines to bunkering pressure from bunker vessel (250 bar max), and leak testing, and opening the H <sub>2</sub> storage tank valve 2. Proper manufacturing, system testing, and leak testing of H <sub>2</sub> piping, storage tank, system 3. Bunker station, H <sub>2</sub> storage area, and tank connection space are classified and restricted (minimizing personnel exposure in case of emergency and restricted access during bunkering)		

No.: 4		H <sub>2</sub> Storage System Location on Wheelhouse Deck (open) (Tanks, Tank Interface, Supports)								
Item	Deviation	Causes	Consequences	Matrix	Severity	Likelihood	Risk	Safeguards	Recommendations	Comment
								4. Bunkering procedures include thermal image scan for hot spots or overheating before starting, equalizing the bunkering lines to bunkering pressure from bunker vessel (250 bar max), and leak testing, and opening the H <sub>2</sub> storage tank valve  5. Crew routine visual inspection of onboard system and equipment during voyage (i.e., for ice formation)  6. Temperature transmitters at each H <sub>2</sub> Storage Tank to provide alarms (L, H) and shutdowns (HH)		



No.: 4		H <sub>2</sub> Storage System Location on Wheelhouse Deck (open) (Tanks, Tank Interface, Supports)								
Item	Deviation	Causes	Consequences	Matrix	Severity	Likelihood	Risk	Safeguards	Recommendations	Comment
								7. H <sub>2</sub> Storage Tank Design such that the tank temperature & pressure operating conditions are within the design limits per tank manufacturer's specifications (i.e., 20 bar normal operating pressure) 8. H <sub>2</sub> Storage Tank Design meets ISO leak-before-failure and fatigue criteria 9. H <sub>2</sub> Storage Tank Design meets marine loading criteria and class rules 10. H <sub>2</sub> Storage Tank Design will be tested for burst failure mode and proper fatigue life		

No.: 4		H <sub>2</sub> Storage System Location on Wheelhouse Deck (open) (Tanks, Tank Interface, Supports)								
Item	Deviation	Causes	Consequences	Matrix	Severity	Likelihood	Risk	Safeguards	Recommendations	Comment
								12. Hydrogen, Fire & Gas (F&G) Detection System monitoring H <sub>2</sub> storage area & bunkering station 13. Emergency Shutdown System (ESD) of H <sub>2</sub> storage system & bunkering station blowdown 14. Pressure monitoring and alarm at bunker manifold and relief valve at bunker manifold		
			2. H <sub>2</sub> storage tank & piping damage	Asset	3	B	Moderate			
		2. Temperature change in atmosphere during voyage	1. High temperature in H <sub>2</sub> storage tank & piping than allowed	Asset	2	C	Moderate	2. Proper manufacturing , system testing, and leak testing of H <sub>2</sub> piping, storage tank, system	7. Develop proper bunkering plan considering the H <sub>2</sub> storage tank charge pressure and settle pressure considering atmospheric condition and temperature.	

No.: 4		H <sub>2</sub> Storage System Location on Wheelhouse Deck (open) (Tanks, Tank Interface, Supports)								
Item	Deviation	Causes	Consequences	Matrix	Severity	Likelihood	Risk	Safeguards	Recommendations	Comment
								5. Crew routine visual inspection of onboard system and equipment during voyage (i.e., for ice formation) 6. Temperature transmitters at each H <sub>2</sub> Storage Tank to provide alarms (L, H) and shutdowns (HH) 7. H <sub>2</sub> Storage Tank Design such that the tank temperature & pressure operating conditions are within the design limits per tank manufacturer's specifications (i.e., 20 bar normal operating pressure) 8. H <sub>2</sub> Storage Tank Design meets ISO leak-before-failure and fatigue criteria		

No.: 4		H <sub>2</sub> Storage System Location on Wheelhouse Deck (open) (Tanks, Tank Interface, Supports)								
Item	Deviation	Causes	Consequences	Matrix	Severity	Likelihood	Risk	Safeguards	Recommendations	Comment
								9. H <sub>2</sub> Storage Tank Design meets marine loading criteria and class rules 10. H <sub>2</sub> Storage Tank Design will be tested for burst failure mode and proper fatigue life 12. Hydrogen, Fire & Gas (F&G) Detection System monitoring H <sub>2</sub> storage area & bunkering station 13. Emergency Shutdown System (ESD) of H <sub>2</sub> storage system & bunkering station blowdown		
			2. H <sub>2</sub> storage tank & piping damage	Asset	3	B	Moderate			
		3. Sun load during voyage	1. High temperature in H <sub>2</sub> storage tank & piping than allowed	Asset	2	C	Moderate	2. Proper manufacturing, system testing, and leak testing of H <sub>2</sub> piping, storage tank, system	7. Develop proper bunkering plan considering the H <sub>2</sub> storage tank charge pressure and settle pressure considering atmospheric condition and temperature.	

No.: 4		H <sub>2</sub> Storage System Location on Wheelhouse Deck (open) (Tanks, Tank Interface, Supports)								
Item	Deviation	Causes	Consequences	Matrix	Severity	Likelihood	Risk	Safeguards	Recommendations	Comment
								5. Crew routine visual inspection of onboard system and equipment during voyage (i.e. for ice formation) 6. Temperature transmitters at each H <sub>2</sub> Storage Tank to provide alarms (L, H) and shutdowns (HH) 7. H <sub>2</sub> Storage Tank Design such that the tank temperature & pressure operating conditions are within the design limits per tank manufacturer's specifications (i.e., 20 bar normal operating pressure) 8. H <sub>2</sub> Storage Tank Design meets ISO leak-before-failure and fatigue criteria		

No.: 4		H <sub>2</sub> Storage System Location on Wheelhouse Deck (open) (Tanks, Tank Interface, Supports)								
Item	Deviation	Causes	Consequences	Matrix	Severity	Likelihood	Risk	Safeguards	Recommendations	Comment
								9. H <sub>2</sub> Storage Tank Design meets marine loading criteria and class rules 10. H <sub>2</sub> Storage Tank Design will be tested for burst failure mode and proper fatigue life 11. H <sub>2</sub> Storage Tanks are wrapped with UV layer protection 12. Hydrogen, Fire & Gas (F&G) Detection System monitoring H <sub>2</sub> storage area & bunkering station 13. Emergency Shutdown System (ESD) of H <sub>2</sub> storage system & bunkering station blowdown		
			2. H <sub>2</sub> storage tank & piping damage	Asset	3	B	Moderate			

No.: 4		H <sub>2</sub> Storage System Location on Wheelhouse Deck (open) (Tanks, Tank Interface, Supports)								
Item	Deviation	Causes	Consequences	Matrix	Severity	Likelihood	Risk	Safeguards	Recommendations	Comment
		4. Fire from main deck (vehicle fire) (linked from 4.3) <b>Comment:</b> External fire event. See scenario 4.4 for more details.								
		5. H <sub>2</sub> leakage upstream of ESDVs to H <sub>2</sub> storage tanks (linked from 4.1) <b>Comment:</b> External fire event. See scenario 4.2 for more details.								
4.9	H <sub>2</sub> storage tank depressurisation (tank liner collapse)	1. Fire or emergency (escalating event) initiating H <sub>2</sub> storage tank blowdown	1. H <sub>2</sub> storage tank liner collapse after tank blowdown due to sudden pressure loss	Asset	2	C	Moderate	1. Blast wall separating the wheelhouse from H <sub>2</sub> storage area 2. Proper manufacturing, tank testing, system testing, and leak testing of H <sub>2</sub> piping, storage tank, system 4. H <sub>2</sub> Storage Tank Design meets ISO leak-before-failure and fatigue criteria 5. H <sub>2</sub> Storage Tank Design meets marine loading criteria and class rules	38. Consult with tank supplier regarding failure modes of the tank (FMECA study) including potential for H <sub>2</sub> storage tank liner collapse during tank blowdown, regular tank pressurisation/depressurisation cycles. 39. Develop operating plan/procedures to verify the H <sub>2</sub> storage tank liner integrity after completing pressurisation. consider keeping a record of tank blowdown events and tank pressurisation cycles. 111. CCPV tank detail FMECA are to be performed 112. After blowdown or extreme low-pressure event develop procedure to do leak test and verify integrity of liner before tank can be used or put in service	

No.: 4		H <sub>2</sub> Storage System Location on Wheelhouse Deck (open) (Tanks, Tank Interface, Supports)								
Item	Deviation	Causes	Consequences	Matrix	Severity	Likelihood	Risk	Safeguards	Recommendations	Comment
								6. H <sub>2</sub> Storage Tank Design will be tested for burst failure mode, sudden pressure loss, proper fatigue life, minor damage to the surface, leak-before-fail etc. 7. Crew routine visual inspection of onboard system and equipment during voyage (i.e. for ice formation) 8. Hydrogen, Fire & Gas (F&G) Detection System monitoring H <sub>2</sub> storage area & bunkering station 9. H <sub>2</sub> leak detection from H <sub>2</sub> storage tank and piping will initiate alarms for operator response and activate ESD system		



No.: 4		H <sub>2</sub> Storage System Location on Wheelhouse Deck (open) (Tanks, Tank Interface, Supports)								
Item	Deviation	Causes	Consequences	Matrix	Severity	Likelihood	Risk	Safeguards	Recommendations	Comment
								10. Pressure transmitters at each H <sub>2</sub> Storage Tank to provide alarms (L, H) and shutdowns (HH)		
			2. Localise delamination-composite and HDPE liners	Asset	2	C	Moderate			
			3. Tank integrity compromised, tank damage	Asset	3	B	Moderate			
			4. H <sub>2</sub> leakage from tank liner (small leak) and unable to hold pressure	Asset	2	C	Moderate			
			5. Fire	Asset	3	B	Moderate			
		2. Regular tank use, pressurisation/depressurisation cycle	1. H <sub>2</sub> storage tank liner collapse after tank blowdown due to sudden pressure loss	Asset	2	C	Moderate	1. Blast wall separating the wheelhouse from H <sub>2</sub> storage area 2. Proper manufacturing, tank testing, system testing, and leak testing of H <sub>2</sub> piping, storage tank, system	38. Consult with tank supplier regarding failure modes of the tank (FMECA study) including potential for H <sub>2</sub> storage tank liner collapse during tank blowdown, regular tank pressurisation/depressurisation cycles. 39. Develop operating plan/procedures to verify the H <sub>2</sub> storage tank liner integrity after completing pressurisation. consider keeping a record of tank blowdown events and tank pressurisation cycles.	

No.: 4		H <sub>2</sub> Storage System Location on Wheelhouse Deck (open) (Tanks, Tank Interface, Supports)								
Item	Deviation	Causes	Consequences	Matrix	Severity	Likelihood	Risk	Safeguards	Recommendations	Comment
								3. H <sub>2</sub> Storage Tank Design such that the tank temperature & pressure operating conditions are within the design limits per tank manufacturer's specifications (i.e., 20 bar normal operating pressure) 4. H <sub>2</sub> Storage Tank Design meets ISO leak-before-failure and fatigue criteria 5. H <sub>2</sub> Storage Tank Design meets marine loading criteria and class rules 6. H <sub>2</sub> Storage Tank Design will be tested for burst failure mode, sudden pressure loss, proper fatigue life, minor damage to the surface, leak-before-fail etc.	111. CCPV tank detail FMECA are to be performed 112. After blowdown or extreme low-pressure event develop procedure to do leak test and verify integrity of liner before tank can be used or put in service	

No.: 4		H <sub>2</sub> Storage System Location on Wheelhouse Deck (open) (Tanks, Tank Interface, Supports)								
Item	Deviation	Causes	Consequences	Matrix	Severity	Likelihood	Risk	Safeguards	Recommendations	Comment
								7. Crew routine visual inspection of onboard system and equipment during voyage (i.e., for ice formation) 8. Hydrogen, Fire & Gas (F&G) Detection System monitoring H <sub>2</sub> storage area & bunkering station 9. H <sub>2</sub> leak detection from H <sub>2</sub> storage tank and piping will initiate alarms for operator response and activate ESD system 10. Pressure transmitters at each H <sub>2</sub> Storage Tank to provide alarms (L, H) and shutdowns (HH) 13. Blowdown of H <sub>2</sub> inventory in H <sub>2</sub> storage tanks & piping		

No.: 4		H <sub>2</sub> Storage System Location on Wheelhouse Deck (open) (Tanks, Tank Interface, Supports)								
Item	Deviation	Causes	Consequences	Matrix	Severity	Likelihood	Risk	Safeguards	Recommendations	Comment
								15. Minimum heel pressure is maintained in all tanks to avoid collapse of liner		
			2. Localise delamination-composite and HDPE liners	Asset	2	C	Moderate			
			3. Tank integrity compromised, tank damage	Asset	3	B	Moderate			
			4. H <sub>2</sub> leakage from tank liner (small leak) and unable to hold pressure	Asset	2	C	Moderate			
4.10	Low temperature in H <sub>2</sub> storage system	1. Bunker system delivering at lower temperature than operating limits	1. Low temperature in H <sub>2</sub> storage system	Asset	1	B	Low	1. Proper manufacturing , system testing, and leak testing of H <sub>2</sub> piping, storage tank, system	47. Confirm temperature limits with tank supplier for H <sub>2</sub> Storage Tank, considering higher and lower temperatures than design limits.	

No.: 4		H <sub>2</sub> Storage System Location on Wheelhouse Deck (open) (Tanks, Tank Interface, Supports)								
Item	Deviation	Causes	Consequences	Matrix	Severity	Likelihood	Risk	Safeguards	Recommendations	Comment
								2. Bunker station, H <sub>2</sub> storage area, and tank connection space are classified and restricted (minimizing personnel exposure in case of emergency and restricted access during bunkering) 3. Bunkering procedures include thermal image scan for hot spots or overheating before starting, equalizing the bunker lines to bunkering pressure from bunker vessel (250 bar max), and leak testing, and opening the H <sub>2</sub> storage tank valve 5. H <sub>2</sub> Storage Tank Design meets marine loading criteria and class rules		

No.: 4		H <sub>2</sub> Storage System Location on Wheelhouse Deck (open) (Tanks, Tank Interface, Supports)								
Item	Deviation	Causes	Consequences	Matrix	Severity	Likelihood	Risk	Safeguards	Recommendations	Comment
								6. H <sub>2</sub> Storage Tank Design will be tested for various failure modes - burst, fatigue, temperature (high/low), damage, leak-before-fail etc. 7. H <sub>2</sub> leak detection from H <sub>2</sub> storage tank and piping will initiate alarms for operator response and activate ESD system 8. Temperature transmitters TT-001 to monitor temperature at the bunkering station and provide alarms (H,L) and shutdown (HH) 9. Temperature transmitters at each H <sub>2</sub> Storage Tank to provide alarms (L,H) and shutdowns (HH)		

No.: 4		H <sub>2</sub> Storage System Location on Wheelhouse Deck (open) (Tanks, Tank Interface, Supports)								
Item	Deviation	Causes	Consequences	Matrix	Severity	Likelihood	Risk	Safeguards	Recommendations	Comment
								10. Emergency Shutdown System (ESD) of H <sub>2</sub> storage system & bunkering station 11. Monitoring crew to manually initiate emergency system shutdown by activating ESD push buttons in case of emergency		
			2. H <sub>2</sub> equipment damage	Asset	3	A	Moderate			
		2. Atmospheric temperature change	1. Low temperature in H <sub>2</sub> storage system	Asset	1	B	Low	1. Proper manufacturing, system testing, and leak testing of H <sub>2</sub> piping, storage tank, system	47. Confirm temperature limits with tank supplier for H <sub>2</sub> Storage Tank, considering higher and lower temperatures than design limits.	

No.: 4		H <sub>2</sub> Storage System Location on Wheelhouse Deck (open) (Tanks, Tank Interface, Supports)								
Item	Deviation	Causes	Consequences	Matrix	Severity	Likelihood	Risk	Safeguards	Recommendations	Comment
								4. H <sub>2</sub> Storage Tank Design such that the tank temperature & pressure operating conditions are within the design limits per tank manufacturer's specifications (i.e., 20 bar normal operating pressure) 5. H <sub>2</sub> Storage Tank Design meets marine loading criteria and class rules 6. H <sub>2</sub> Storage Tank Design will be tested for various failure modes - burst, fatigue, temperature (high/low), damage, leak-before-fail etc.		



No.: 4		H <sub>2</sub> Storage System Location on Wheelhouse Deck (open) (Tanks, Tank Interface, Supports)								
Item	Deviation	Causes	Consequences	Matrix	Severity	Likelihood	Risk	Safeguards	Recommendations	Comment
								7. H <sub>2</sub> leak detection from H <sub>2</sub> storage tank and piping will initiate alarms for operator response and activate ESD system 8. Temperature transmitters TT-001 to monitor temperature at the bunkering station and provide alarms (H,L) and shutdown (HH) 9. Temperature transmitters at each H <sub>2</sub> Storage Tank to provide alarms (L, H) and shutdowns (HH) 10. Emergency Shutdown System (ESD) of H <sub>2</sub> storage system & bunkering station		

No.: 4		H <sub>2</sub> Storage System Location on Wheelhouse Deck (open) (Tanks, Tank Interface, Supports)								
Item	Deviation	Causes	Consequences	Matrix	Severity	Likelihood	Risk	Safeguards	Recommendations	Comment
4.11	H <sub>2</sub> Storage Tank gassing up, degassing, purging - general recommendations	1. General recommendations to improve design.							<p>75. Develop procedures to conduct H<sub>2</sub> storage tank inspection, tank purging with N<sub>2</sub>, gassing and degassing sequences. Operation will be done at port (i.e., local maintenance shipyard) with crew restrictions, and planned detailed procedures, ensure sufficient N<sub>2</sub> bottles are available. Develop the requirements and expected amount of N<sub>2</sub> supply at a detail design stage.</p> <p>76. Develop loading and unloading plan for N<sub>2</sub> bottles and ensure appropriate restrictions are in place. Since N<sub>2</sub> bottles will be periodically replaced for H<sub>2</sub> tank purging operations.</p> <p>77. During bunkering and idle period, H<sub>2</sub> will be maintained in all H<sub>2</sub> lines up to the isolation valve to each Fuel Cell unit, so develop procedures to maintain H<sub>2</sub> in the lines and detail HAZOP to be conducted to understand the risks.</p> <p>113. N<sub>2</sub> quality requirement to be established in particular O<sub>2</sub> content to be max 1%.</p>	<ul style="list-style-type: none"> <li>-N<sub>2</sub> connection at each H<sub>2</sub> bottles</li> <li>- tank gassing up: purge air with N<sub>2</sub>, measure the concentration of O<sub>2</sub> to confirm N<sub>2</sub> rich environment, fill the tank with H<sub>2</sub>, then disconnect the N<sub>2</sub> bottles</li> <li>- tank degassing: reverse operation</li> <li>- sampling of concentration at double block and bleed valve</li> <li>- gassing/degassing operations will happen in port with crew restrictions, separate operation</li> <li>-</li> </ul>

No.: 4		H <sub>2</sub> Storage System Location on Wheelhouse Deck (open) (Tanks, Tank Interface, Supports)								
Item	Deviation	Causes	Consequences	Matrix	Severity	Likelihood	Risk	Safeguards	Recommendations	Comment
4.12	H <sub>2</sub> Tank failure due to manufacturing defects	1. H <sub>2</sub> Tank rupture due to manufacturing defects, excessive heat	1. H <sub>2</sub> Tank rupture & stored energy release, impact on surrounding tanks	Asset	4	B	High	1. Proper manufacturing, system testing, and leak testing of H <sub>2</sub> piping, storage tank, system 2. A60 insulation below the H <sub>2</sub> storage area (bridge deck) & on the main deck (underneath) 3. Blast wall separating the wheelhouse from H <sub>2</sub> storage area * 4. Bunker station, H <sub>2</sub> storage area, and tank connection space are classified and restricted (minimizing personnel exposure in case of emergency and restricted access during bunkering)	88. Consider verifying the H <sub>2</sub> storage tank design standard, tank testing, and manufacturing plan from tank supplier to minimise manufacturing defects. Also evaluate the impact of tank rupture on ferry pilot house and structures and evaluate the effectiveness of tank protections. 91. Evaluate the blast wall design considering the potential H <sub>2</sub> tank rupture scenario. If appropriately designed, this can be a safeguard for H <sub>2</sub> Tank rupture scenario.	- CCPV tank rupture incident has occurred in industry, typically during tank charging - 250 bar Type 4 tank design and the # of tanks was selected due to smaller tank sizing and to have the ability to install H <sub>2</sub> tanks in interior space without spacing issues.

No.: 4		H <sub>2</sub> Storage System Location on Wheelhouse Deck (open) (Tanks, Tank Interface, Supports)								
Item	Deviation	Causes	Consequences	Matrix	Severity	Likelihood	Risk	Safeguards	Recommendations	Comment
								5. H <sub>2</sub> Storage Tank foundation & support design will meet IGF code requirements 6. H <sub>2</sub> Storage Tank Design such that the tank temperature & pressure operating conditions are within the design limits per tank manufacturer's specifications (i.e., 20 bar normal operating pressure) 7. H <sub>2</sub> Storage Tank Design meets ISO leak-before-failure and fatigue criteria 8. H <sub>2</sub> Storage Tank Design meets marine loading criteria and class rules 9. H <sub>2</sub> Storage Tank Design will be tested for burst failure mode and proper fatigue life		

No.: 4		H <sub>2</sub> Storage System Location on Wheelhouse Deck (open) (Tanks, Tank Interface, Supports)								
Item	Deviation	Causes	Consequences	Matrix	Severity	Likelihood	Risk	Safeguards	Recommendations	Comment
								11. Crew routine visual inspection of onboard system and equipment during voyage (i.e., for ice formation) 12. H <sub>2</sub> leak detection from H <sub>2</sub> storage tank and piping will initiate alarms for operator response and activate ESD system 13. Crew is equipped with Personnel Protective Equipment (PPE) 14. FAT on tank before installation and leak test after installation		
			2. Ferry pilot house damage and structural damage	Asset	4	B	High			
			3. Personnel injury	Injury	4	A	High			

No.: 4		H <sub>2</sub> Storage System Location on Wheelhouse Deck (open) (Tanks, Tank Interface, Supports)								
Item	Deviation	Causes	Consequences	Matrix	Severity	Likelihood	Risk	Safeguards	Recommendations	Comment
4.13	Tank fatigue failure from dome area liner or connections	1. Tank fatigue failure from dome area liner or connections	1. H <sub>2</sub> leakage from H <sub>2</sub> storage tank	Asset	2	C	Moderate	1. Proper manufacturing, system testing, and leak testing of H <sub>2</sub> piping, storage tank, system 2. A60 insulation below the H <sub>2</sub> storage area (bridge deck) & on the main deck (underneath) 3. Blast wall separating the wheelhouse from H <sub>2</sub> storage area * 4. Bunker station, H <sub>2</sub> storage area, and tank connection space are classified and restricted (minimizing personnel exposure in case of emergency and restricted access during bunkering)		

No.: 4		H <sub>2</sub> Storage System Location on Wheelhouse Deck (open) (Tanks, Tank Interface, Supports)								
Item	Deviation	Causes	Consequences	Matrix	Severity	Likelihood	Risk	Safeguards	Recommendations	Comment
								5. H <sub>2</sub> Storage Tank foundation & support design will meet IGF code requirements 6. H <sub>2</sub> Storage Tank Design such that the tank temperature & pressure operating conditions are within the design limits per tank manufacturer's specifications (i.e., 20 bar normal operating pressure) 7. H <sub>2</sub> Storage Tank Design meets ISO leak-before-failure and fatigue criteria 8. H <sub>2</sub> Storage Tank Design meets marine loading criteria and class rules		

No.: 4		H <sub>2</sub> Storage System Location on Wheelhouse Deck (open) (Tanks, Tank Interface, Supports)								
Item	Deviation	Causes	Consequences	Matrix	Severity	Likelihood	Risk	Safeguards	Recommendations	Comment
								9. Monitoring crew to manually initiate emergency system shutdown by activating ESD push buttons in case of emergency 10. Crew routine visual inspection of onboard system and equipment during voyage (i.e., for ice formation) 11. H <sub>2</sub> leak detection from H <sub>2</sub> storage tank and piping will initiate alarms for operator response and activate ESD system 12. Crew is equipped with Personnel Protective Equipment (PPE) 13. Blowdown		
			2. Fire	Overall	S4-Major	LB-Unlikely	High			
			3. Explosion	Overall	S4-Major	LB-Unlikely	High			



No.: 4		H <sub>2</sub> Storage System Location on Wheelhouse Deck (open) (Tanks, Tank Interface, Supports)								
Item	Deviation	Causes	Consequences	Matrix	Severity	Likelihood	Risk	Safeguards	Recommendations	Comment
4.14	Vibration issues	1. Ship vibration impacting H <sub>2</sub> piping and connections	1. Fatigue failure leading to H <sub>2</sub> leakage	Asset	2	C	Moderate	1. Proper manufacturing, system testing, and leak testing of H <sub>2</sub> piping, storage tank, system 2. A60 insulation below the H <sub>2</sub> storage area (bridge deck) & on the main deck (underneath) 3. Blast wall separating the wheelhouse from H <sub>2</sub> storage area * 4. Bunker station, H <sub>2</sub> storage area, and tank connection space are classified and restricted (minimizing personnel exposure in case of emergency and restricted access during bunkering)	89. Consider conducting a vibration study on the concept design to understand the impact of vibration issues on H <sub>2</sub> piping and connections which may lead to H <sub>2</sub> leakage hazards. 90. Discuss H <sub>2</sub> system threaded connections acceptance with class and regulators.	- new technology in marine environment may introduce vibration issues

No.: 4		H <sub>2</sub> Storage System Location on Wheelhouse Deck (open) (Tanks, Tank Interface, Supports)								
Item	Deviation	Causes	Consequences	Matrix	Severity	Likelihood	Risk	Safeguards	Recommendations	Comment
								5. H <sub>2</sub> Storage Tank foundation & support design will meet IGF code requirements 6. H <sub>2</sub> Storage Tank Design such that the tank temperature & pressure operating conditions are within the design limits per tank manufacturer's specifications (i.e. 20 bar normal operating pressure) 7. H <sub>2</sub> Storage Tank Design meets ISO leak-before-failure and fatigue criteria 8. H <sub>2</sub> Storage Tank Design meets marine loading criteria and class rules 9. H <sub>2</sub> Storage Tank Design will be tested for burst failure mode and proper fatigue life		

No.: 4		H <sub>2</sub> Storage System Location on Wheelhouse Deck (open) (Tanks, Tank Interface, Supports)								
Item	Deviation	Causes	Consequences	Matrix	Severity	Likelihood	Risk	Safeguards	Recommendations	Comment
								10. Monitoring crew to manually initiate emergency system shutdown by activating ESD push buttons in case of emergency 11. Crew routine visual inspection of onboard system and equipment during voyage (i.e., for ice formation) 12. H <sub>2</sub> leak detection from H <sub>2</sub> storage tank and piping will initiate alarms for operator response and activate ESD system 13. Crew is equipped with Personnel Protective Equipment (PPE)		
			2. Equipment damage	Asset	2	C	Moderate			
			3. Fire	Overall	S4-Major	LB-Unlikely	High			
			4. Explosion	Overall	S4-Major	LB-Unlikely	High			

5	<p>H<sub>2</sub> Storage System Location Below Deck (Tanks, Tank Interface, Supports)</p> <p>Section notes:</p> <ul style="list-style-type: none"> <li>- H<sub>2</sub> storage tank &amp; pressure reducing station in an enclosed space below the main deck</li> <li>- H<sub>2</sub> piping passing outboard of the main deck</li> <li>- design details (i.e. inerting) not available</li> <li>- access to this space is from the car deck</li> <li>- requirement for sloping deck head to prevent H<sub>2</sub> pockets from forming</li> </ul> <p>H<sub>2</sub> Storage System Location Below Deck (enclosed): (See 025141 Machinery Concept Sketches document and internal storage ppt)</p> <ul style="list-style-type: none"> <li>- regulate environment</li> <li>- protection from dropped objects</li> <li>- tanks and piping are more secure, less risk of malicious damage</li> <li>- can limit or control leakage to extent</li> </ul> <p>Internal H<sub>2</sub> tank main design challenges:</p> <p>Evacuation of any leak and potential to create explosive atmosphere.</p> <p>Proximity of H<sub>2</sub> to personnel</p> <p>Creation of a hazardous area within the hull, requiring dedicated ventilation and bilge systems</p> <p>Large storage of energy due to the compressed gas. Sudden release of which could exceed the design values of bulkheads and structure</p> <p>Ability to inspect, maintain and replace / service storage tanks in a confined space and with limited removal options.</p> <p>Location of tanks in an unmanned inerted space raises redundancy and maintenance issues.</p> <p>Deck head structural requirements to minimise possibility of gas accumulation</p> <p>B/5 breadth damage line restrictions. B/15 above keel, Longitudinal limits 0.08 L aft of FP and B/10 from AP</p> <p>Internal Hydrogen Storage (Gas Bottles)</p> <p>H<sub>2</sub> Storage Hold Requirements/Desirables:</p> <ul style="list-style-type: none"> <li>- Hold space itself becomes a zone 1 hazardous area and can be considered a coffer dam around the tanks.</li> <li>- Hold space is inerted with N<sub>2</sub> as this is considered the safest method of minimizing the risk of leakage and maintaining an inert atmosphere around the tanks.</li> <li>- Space is unmanned and is not accessible until space is gas freed. Classed as a confined space.</li> <li>- minimizing complexity of the system to avoid excessive number of valves and pipes within the space was required. Bottles arranged into tank banks with 6 bottles effectively making up one H<sub>2</sub> storage volume.</li> <li>- Pressure reducing station located within the space so that HP H<sub>2</sub> is limited to the H<sub>2</sub> storage hold.</li> <li>- Pressure relief required on the hold. Suggested to size this for overpressure caused by major gas release from storage tanks (1 bank of bottles). Sizing of this has not been carried out yet but concept is on the following slide.</li> <li>- Considering N<sub>2</sub> requirements, storage bottles deemed insufficient in this case and N<sub>2</sub> generator installed.</li> </ul> <p>Applicable IGF requirements:</p> <p>9.4 Regulations on safety functions of gas supply system</p> <p>9.4.1 Fuel storage tank inlets and outlets shall be provided with valves located as close to the tank as possible. Valves required to be operated during normal operation* which are not accessible shall be remotely operated. Tank valves whether accessible or not shall be automatically operated when the safety system required in 15.2.2 is activated.</p> <p>* Normal operation in this context is when gas is supplied to consumers and during bunkering operations.</p> <p>9.4.2 The main gas supply line to each gas consumer or set of consumers shall be equipped with a manually operated stop valve and an automatically operated "master gas fuel valve" coupled in series or a combined manually and automatically operated valve. The valves shall be situated in the part of the piping that is outside the machinery space containing gas consumers and placed as near as possible to the installation for heating the gas, if fitted. The master gas fuel valve shall automatically cut off the gas supply when activated by the safety system required in 15.2.2.</p> <p>9.4.8 There shall be one manually operated shutdown valve in the gas supply line to each engine upstream of the double block and bleed valves to assure safe isolation during maintenance on the engine.</p>
---	--

No.: 5		H <sub>2</sub> Storage System Location Below Deck (Tanks, Tank Interface, Supports)								
Item	Deviation	Causes	Consequences	Matrix	Severity	Likelihood	Risk	Safeguards	Recommendations	Comment
5.1	H <sub>2</sub> leakage upstream of ESDVs to H <sub>2</sub> storage tanks	1. Connection leaks, vibration, fatigue failure, corrosion <b>Comment:</b> - leaks from connections near the H <sub>2</sub> storage tank can lead to jet fire impinging on the H <sub>2</sub> storage tank or a surrounding H <sub>2</sub> tank.	1. H <sub>2</sub> release from individual H <sub>2</sub> storage tank	Asset	2	C	Moderate	1. Proper manufacturing, system testing, and leak testing of H <sub>2</sub> piping, storage tank, system 2. A60 insulation below the H <sub>2</sub> storage area (upper deck) & on the main deck (underneath) 3. System design such that all piping is welded with no joints or connections (minimizing H <sub>2</sub> leakages) 4. Hydrogen, Fire & Gas (F&G) Detection System monitoring H <sub>2</sub> storage area & bunkering station 5. Pressure transmitters to monitor H <sub>2</sub> piping and piping annulus space (N <sub>2</sub> )	1. Conduct Fire Hazards Analysis, Gas Dispersion Analysis, Explosion Analysis to establish hazardous area zones and hazardous impact. Provide appropriate mitigations for fire and explosion consequences. Evaluate if the vessel structural damage due to explosion can compromise the damage stability and integrity of the vessel. Evaluate the vent mast design and hazardous area zone established by the vent mast. 26. Proper selection of thermal protections to be provided considering the sensitivity of H <sub>2</sub> storage tank due to thermal impact or jet fire impingement or alternate arrangement to avoid jet impingement. 27. Consider the design and arrangements of H <sub>2</sub> storage tanks to avoid any jet fire impingement on the tank due to connection leakage. 28. Evaluate the effectiveness of F&G Detection in the H <sub>2</sub> storage area when the location is open on the wheelhouse deck. 29. Study the leak detection mechanisms to provide early leakage detection in case of leaks from H <sub>2</sub> storage tanks.	- ESDVs: ESDV-003 to ESDV-013 are automatic valves, rated for hazardous zone, and located close to the tanks - piping and connections located in front of the tanks - leakage upstream of ESDVs will be higher

No.: 5		H <sub>2</sub> Storage System Location Below Deck (Tanks, Tank Interface, Supports)								
Item	Deviation	Causes	Consequences	Matrix	Severity	Likelihood	Risk	Safeguards	Recommendations	Comment
								6. H <sub>2</sub> leak detection from H <sub>2</sub> storage tank and piping will initiate alarms for operator response and activate ESD system 7. Emergency Shutdown System (ESD) of H <sub>2</sub> storage system & bunkering station 8. Firefighting system: activation of water sprays in case of fire onboard 9. Crew is equipped with Personnel Protective Equipment (PPE) 10. Bunkering crew is equipped with portable gas detectors	30. Investigate mechanisms for H <sub>2</sub> storage tank monitoring system (i.e., volume %) and programmable control logic to provide early leak detection from a H <sub>2</sub> tank. 31. Develop firefighting philosophy including F&G detection, surface temperature detection, shutdown & blowdown initiation, and cooling of H <sub>2</sub> tanks in case of fire. 32. Evaluate the surface temperature detection philosophy and its interaction with other tank protection mechanisms in case of fire impacting the H <sub>2</sub> storage tank. 33. Investigate the effectiveness of the water spray system such as nozzle arrangement, coverage zone, etc. in case of H <sub>2</sub> storage tank fire. Consider the potential for the water spray system activation to compromise the effectiveness of the H <sub>2</sub> tank thermal protection (i.e., thermal pressure relief device (TPRD)). 40. In the case of H <sub>2</sub> Storage System location below deck (enclosed compartment), the atmosphere inside the small compartment, dry air or inerted, are to be determined and risk to be evaluated with selection.	

No.: 5		H <sub>2</sub> Storage System Location Below Deck (Tanks, Tank Interface, Supports)								
Item	Deviation	Causes	Consequences	Matrix	Severity	Likelihood	Risk	Safeguards	Recommendations	Comment
									<p>41. H<sub>2</sub> Storage Tank isolations are to be evaluated considering IGF code requirements. Currently, the tank isolation valves are manual valves (i.e., 21-DB-06 and 21-NE-01).</p> <p>42. Provide adequate relief protections for the H<sub>2</sub> Storage Tank space in case of leakage from H<sub>2</sub> piping.</p> <p>43. Consider providing pressure monitoring in the H<sub>2</sub> Storage compartment in case of H<sub>2</sub> leak from piping, connections which can lead to over pressurisation in the small compartment.</p> <p>44. Provide temperature monitoring in the H<sub>2</sub> storage compartment to detect heat load and protect the H<sub>2</sub> storage tank.</p> <p>56. Consider putting all connections and piping from H<sub>2</sub> storage compartment below deck into a Tank Connection Space (TCS). TCS ventilation and vent system are to be developed.</p>	

No.: 5		H <sub>2</sub> Storage System Location Below Deck (Tanks, Tank Interface, Supports)								
Item	Deviation	Causes	Consequences	Matrix	Severity	Likelihood	Risk	Safeguards	Recommendations	Comment
									106. Conduct Fire Hazards Analysis, Gas Dispersion Analysis, Explosion Analysis to establish hazardous area zones and hazardous impact. Provide appropriate mitigations for fire and explosion consequences. Evaluate if the vessel structural damage due to explosion can compromise the damage stability and integrity of the vessel. Evaluate the vent mast design and hazardous area zone established by the vent mast. 114. Evaluate effectiveness of F&G detection in the H <sub>2</sub> storage area (closed/congested/below deck) 115. Deflagration/detonation protection to be consider for space	
			2. Jet fire impinging on H <sub>2</sub> tank or surrounding tank	Overall	S4-Major	LB-Unlikely	High			
			3. Over pressurisation in small compartment	Asset	3	B	Moderate			
			4. Tank Explosion	Overall	S4-Major	LB-Unlikely	High			
			5. Explosion (deflagration/detonation) in the small compartment (close space)	Overall	S4-Major	LB-Unlikely	High			



No.: 5		H <sub>2</sub> Storage System Location Below Deck (Tanks, Tank Interface, Supports)								
Item	Deviation	Causes	Consequences	Matrix	Severity	Likelihood	Risk	Safeguards	Recommendations	Comment
			6. Vessel structural damage due to explosion compromising stability/water ingress	Overall	S5-Critical	LB-Unlikely	Extreme			
5.2	H <sub>2</sub> leakage downstream of ESDVs to H <sub>2</sub> storage tanks	1. Connection leaks, vibration, fatigue failure, corrosion	1. H <sub>2</sub> release	Asset	2	C	Moderate	1. Proper manufacturing, system testing, and leak testing of H <sub>2</sub> piping, storage tank, system 2. A60 insulation below the H <sub>2</sub> storage area (upper deck) & on the main deck (underneath) 3. System design such that all piping is welded with no joints or connections (minimizing H <sub>2</sub> leakages) 4. Hydrogen, Fire & Gas (F&G) Detection System monitoring H <sub>2</sub> storage area & bunkering station	40. In the case of H <sub>2</sub> Storage System location below deck (enclosed compartment), the atmosphere inside the small compartment, dry air or inerted, are to be determined and risk to be evaluated with selection. 45. Evaluate the appropriate H <sub>2</sub> detection technology since currently available H <sub>2</sub> detectors require an atmospheric environment with O <sub>2</sub> and will not work in an inerted environment. 46. Evaluate the isolation and blowdown philosophies for H <sub>2</sub> Storage Tank, considering the tank location in enclosed compartment. 116. Consider all piping in tank connection space (TCS). TCS ventilation and vent mast to be developed.	- ESDVs will be located close to the H <sub>2</sub> storage tanks - ESDVs are fail closed automatic valves - before ESDV-014 master H <sub>2</sub> supply valve to fuel cell system

No.: 5		H <sub>2</sub> Storage System Location Below Deck (Tanks, Tank Interface, Supports)								
Item	Deviation	Causes	Consequences	Matrix	Severity	Likelihood	Risk	Safeguards	Recommendations	Comment
								5. H <sub>2</sub> leak detection from H <sub>2</sub> storage tank and piping will initiate alarms for operator response and activate ESD system 6. Emergency Shutdown System (ESD) of H <sub>2</sub> storage system & bunkering station 7. Firefighting system: activation of water sprays in case of fire onboard 8. Crew is equipped with Personnel Protective Equipment (PPE) 9. Double wall piping		
			2. Jet fire	Overall	S4-Major	LB-Unlikely	High			

No.: 5		H <sub>2</sub> Storage System Location Below Deck (Tanks, Tank Interface, Supports)								
Item	Deviation	Causes	Consequences	Matrix	Severity	Likelihood	Risk	Safeguards	Recommendations	Comment
5.3	Fire from main deck (vehicle fire)	1. Vehicle fire on main deck	1. High temperature on H <sub>2</sub> storage compartment (enclosed) below deck	Asset	2	C	Moderate	1. Proper manufacturing, system testing, and leak testing of H <sub>2</sub> piping, storage tank, system 2. A60 rated main deck in storage area compartment 5. Pressure transmitters at each H <sub>2</sub> Storage Tank to provide alarms (L, H) and shutdowns (HH) 6. Temperature transmitters at each H <sub>2</sub> Storage Tank to provide alarms (L, H) and shutdowns (HH) 7. Emergency Shutdown System (ESD) of H <sub>2</sub> storage system & bunkering station	1. Conduct Fire Hazards Analysis, Gas Dispersion Analysis, Explosion Analysis to establish hazardous area zones and hazardous impact. Provide appropriate mitigations for fire and explosion consequences. Evaluate if the vessel structural damage due to explosion can compromise the damage stability and integrity of the vessel. Evaluate the vent mast design and hazardous area zone established by the vent mast.	

No.: 5		H <sub>2</sub> Storage System Location Below Deck (Tanks, Tank Interface, Supports)								
Item	Deviation	Causes	Consequences	Matrix	Severity	Likelihood	Risk	Safeguards	Recommendations	Comment
								8. Blowdown of H <sub>2</sub> inventory in H <sub>2</sub> storage tanks & piping 9. Pressure Relief Valves on H <sub>2</sub> Storage Tank 10. Firefighting system initiate to fight vehicle fire on the main deck 11. Crew is equipped with Personnel Protective Equipment (PPE) 12. Firefighting in CCPV compartment - water spray 13. Double wall piping		
			2. H <sub>2</sub> storage tank integrity compromised	Asset	2	C	Moderate			
			3. Increase internal pressure in H <sub>2</sub> tank due to heat gain	Asset	3	B	Moderate			

No.: 5		H <sub>2</sub> Storage System Location Below Deck (Tanks, Tank Interface, Supports)								
Item	Deviation	Causes	Consequences	Matrix	Severity	Likelihood	Risk	Safeguards	Recommendations	Comment
5.4	High pressure in H <sub>2</sub> storage system	1. Bunker system delivering at higher pressure than operating limits	1. Overpressure in H <sub>2</sub> storage tank & piping	Asset	2	C	Moderate	1. Proper manufacturing, system testing, and leak testing of H <sub>2</sub> piping, storage tank, system 2. Bunker station, H <sub>2</sub> storage area, and tank connection space are classified and restricted (minimizing personnel exposure in case of emergency and restricted access during bunkering)		

No.: 5		H <sub>2</sub> Storage System Location Below Deck (Tanks, Tank Interface, Supports)								
Item	Deviation	Causes	Consequences	Matrix	Severity	Likelihood	Risk	Safeguards	Recommendations	Comment
								3. Bunkering procedures include thermal image scan for hot spots or overheating before starting, equalizing the bunker lines to bunkering pressure from bunker vessel (250 bar max), and leak testing, and opening the H <sub>2</sub> storage tank valve 4. H <sub>2</sub> Storage Tank Design such that the tank temperature & pressure operating conditions are within the design limits per tank manufacturer's specifications (i.e., 20 bar normal operating pressure)		

No.: 5		H <sub>2</sub> Storage System Location Below Deck (Tanks, Tank Interface, Supports)								
Item	Deviation	Causes	Consequences	Matrix	Severity	Likelihood	Risk	Safeguards	Recommendations	Comment
								5. H <sub>2</sub> Storage Tank Design meets ISO leak-before-failure and fatigue criteria 6. H <sub>2</sub> Storage Tank Design meets marine loading criteria and class rules 7. H <sub>2</sub> Storage Tank Design will be tested for burst failure mode and proper fatigue life 8. H <sub>2</sub> Storage Tanks are wrapped with UV layer protection 9. Crew routine visual inspection of onboard system and equipment during voyage (i.e., for ice formation)		

No.: 5		H <sub>2</sub> Storage System Location Below Deck (Tanks, Tank Interface, Supports)								
Item	Deviation	Causes	Consequences	Matrix	Severity	Likelihood	Risk	Safeguards	Recommendations	Comment
								10. H <sub>2</sub> leak detection from H <sub>2</sub> storage tank and piping will initiate alarms for operator response and activate ESD system 11. Pressure transmitters at each H <sub>2</sub> Storage Tank to provide alarms (L, H) and shutdowns (HH) 12. Emergency Shutdown System (ESD) of H <sub>2</sub> storage system & bunkering station 13. Blowdown of H <sub>2</sub> inventory in H <sub>2</sub> storage tanks & piping 14. Pressure Relief Valves on H <sub>2</sub> Storage Tank 15. Double wall piping		
			2. H <sub>2</sub> storage tank & piping damage	Asset	3	B	Moderate			



No.: 5		H <sub>2</sub> Storage System Location Below Deck (Tanks, Tank Interface, Supports)								
Item	Deviation	Causes	Consequences	Matrix	Severity	Likelihood	Risk	Safeguards	Recommendations	Comment
5.5	High temperature in H <sub>2</sub> storage system	1. Bunker system delivering at higher temperature than operating limits	1. High temperature in H <sub>2</sub> storage tank & piping	Asset	2	C	Moderate	1. Bunkering procedures include thermal image scan for hot spots or overheating before starting, equalizing the bunker lines to bunkering pressure from bunker vessel (250 bar max), and leak testing, and opening the H <sub>2</sub> storage tank valve 2. Proper manufacturing, system testing, and leak testing of H <sub>2</sub> piping, storage tank, system	47. Confirm temperature limits with tank supplier for H <sub>2</sub> Storage Tank, considering higher and lower temperatures than design limits.	

No.: 5		H <sub>2</sub> Storage System Location Below Deck (Tanks, Tank Interface, Supports)								
Item	Deviation	Causes	Consequences	Matrix	Severity	Likelihood	Risk	Safeguards	Recommendations	Comment
								3. Bunker station, H <sub>2</sub> storage area, and tank connection space are classified and restricted (minimizing personnel exposure in case of emergency and restricted access during bunkering) 4. Bunkering procedures include thermal image scan for hot spots or overheating before starting, equalizing the bunker lines to bunkering pressure from bunker vessel (250 bar max), and leak testing, and opening the H <sub>2</sub> storage tank valve		

No.: 5		H <sub>2</sub> Storage System Location Below Deck (Tanks, Tank Interface, Supports)								
Item	Deviation	Causes	Consequences	Matrix	Severity	Likelihood	Risk	Safeguards	Recommendations	Comment
								5. Crew routine visual inspection of onboard system and equipment during voyage (i.e., for ice formation) 6. Temperature transmitters at each H <sub>2</sub> Storage Tank to provide alarms (L, H) and shutdowns (HH) 7. H <sub>2</sub> Storage Tank Design such that the tank temperature & pressure operating conditions are within the design limits per tank manufacturer's specifications (i.e., 20 bar normal operating pressure)		

No.: 5		H <sub>2</sub> Storage System Location Below Deck (Tanks, Tank Interface, Supports)								
Item	Deviation	Causes	Consequences	Matrix	Severity	Likelihood	Risk	Safeguards	Recommendations	Comment
								8. H <sub>2</sub> Storage Tank Design meets ISO leak-before-failure and fatigue criteria 9. H <sub>2</sub> Storage Tank Design meets marine loading criteria and class rules 10. H <sub>2</sub> Storage Tank Design will be tested for burst failure mode and proper fatigue life 12. Hydrogen, Fire & Gas (F&G) Detection System monitoring H <sub>2</sub> storage area & bunkering station 13. Emergency Shutdown System (ESD) of H <sub>2</sub> storage system & bunkering station		
			2. H <sub>2</sub> storage tank & piping damage	Asset	3	B	Moderate			

No.: 5		H <sub>2</sub> Storage System Location Below Deck (Tanks, Tank Interface, Supports)								
Item	Deviation	Causes	Consequences	Matrix	Severity	Likelihood	Risk	Safeguards	Recommendations	Comment
		2. Temperature change in atmosphere during voyage	1. High temperature in H <sub>2</sub> storage tank & piping	Asset	2	C	Moderate	2. Proper manufacturing, system testing, and leak testing of H <sub>2</sub> piping, storage tank, system  5. Crew routine visual inspection of onboard system and equipment during voyage (i.e., for ice formation)  6. Temperature transmitters at each H <sub>2</sub> Storage Tank to provide alarms (L, H) and shutdowns (HH)		

No.: 5		H <sub>2</sub> Storage System Location Below Deck (Tanks, Tank Interface, Supports)								
Item	Deviation	Causes	Consequences	Matrix	Severity	Likelihood	Risk	Safeguards	Recommendations	Comment
								7. H <sub>2</sub> Storage Tank Design such that the tank temperature & pressure operating conditions are within the design limits per tank manufacturer's specifications (i.e., 20 bar normal operating pressure) 8. H <sub>2</sub> Storage Tank Design meets ISO leak-before-failure and fatigue criteria 9. H <sub>2</sub> Storage Tank Design meets marine loading criteria and class rules 10. H <sub>2</sub> Storage Tank Design will be tested for burst failure mode and proper fatigue life		

No.: 5		H <sub>2</sub> Storage System Location Below Deck (Tanks, Tank Interface, Supports)								
Item	Deviation	Causes	Consequences	Matrix	Severity	Likelihood	Risk	Safeguards	Recommendations	Comment
								12. Hydrogen, Fire & Gas (F&G) Detection System monitoring H <sub>2</sub> storage area & bunkering station 13. Emergency Shutdown System (ESD) of H <sub>2</sub> storage system & bunkering station		
			2. H <sub>2</sub> storage tank & piping damage	Asset	3	B	Moderate			
		3. Fire from main deck (vehicle fire) * (linked from 4.4) <b>Comment:</b> External fire event. See scenario 4.4 for more details.								
		4. H <sub>2</sub> leakage upstream of ESDVs to H <sub>2</sub> storage tanks * (linked from 4.2) <b>Comment:</b> External fire event. See scenario 4.2 for more details.								
5.6	H <sub>2</sub> storage tank depressurisation (tank liner collapse)	1. Fire or emergency (escalating event) initiating H <sub>2</sub> storage tank blowdown	1. H <sub>2</sub> storage tank liner collapse to be tank blowdown	Asset	1	C	Low	1. Proper manufacturing, system testing, and leak testing of H <sub>2</sub> piping, storage tank, system	38. Consult with tank supplier regarding failure modes of the tank (FMECA study) including potential for H <sub>2</sub> storage tank liner collapse during tank blowdown, regular tank pressurisation/depressurisation cycles.	

No.: 5		H <sub>2</sub> Storage System Location Below Deck (Tanks, Tank Interface, Supports)								
Item	Deviation	Causes	Consequences	Matrix	Severity	Likelihood	Risk	Safeguards	Recommendations	Comment
								2. H <sub>2</sub> Storage Tank Design such that the tank temperature & pressure operating conditions are within the design limits per tank manufacturer's specifications (i.e., 20 bar normal operating pressure) 3. H <sub>2</sub> Storage Tank Design meets ISO leak-before-failure and fatigue criteria 4. H <sub>2</sub> Storage Tank Design meets marine loading criteria and class rules 5. H <sub>2</sub> Storage Tank Design will be tested for burst failure mode and proper fatigue life	39. Develop operating plan/procedures to verify the H <sub>2</sub> storage tank liner integrity after completing pressurisation. consider keeping a record of tank blowdown events and tank pressurisation cycles.	



No.: 5		H <sub>2</sub> Storage System Location Below Deck (Tanks, Tank Interface, Supports)								
Item	Deviation	Causes	Consequences	Matrix	Severity	Likelihood	Risk	Safeguards	Recommendations	Comment
								6. Crew routine visual inspection of onboard system and equipment during voyage (i.e., for ice formation) 7. Hydrogen, Fire & Gas (F&G) Detection System monitoring H <sub>2</sub> storage area & bunkering station 8. H <sub>2</sub> leak detection from H <sub>2</sub> storage tank and piping will initiate alarms for operator response and activate ESD system 9. Pressure transmitters at each H <sub>2</sub> Storage Tank to provide alarms (L, H) and shutdowns (HH)		

No.: 5		H <sub>2</sub> Storage System Location Below Deck (Tanks, Tank Interface, Supports)								
Item	Deviation	Causes	Consequences	Matrix	Severity	Likelihood	Risk	Safeguards	Recommendations	Comment
								10. Temperature transmitters at each H <sub>2</sub> Storage Tank to provide alarms (L, H) and shutdowns (HH) 11. Emergency Shutdown System (ESD) of H <sub>2</sub> storage system & bunkering station 12. Blowdown of H <sub>2</sub> inventory in H <sub>2</sub> storage tanks & piping 13. Pressure Relief Valves on H <sub>2</sub> Storage Tank		
			2. Localise delamination with carbon resin	Asset	2	B	Low			
			3. Tank integrity compromised, damage	Asset	3	B	Moderate			
			4. H <sub>2</sub> leakage from tank liner (small leak)	Asset	2	B	Low			

No.: 5		H <sub>2</sub> Storage System Location Below Deck (Tanks, Tank Interface, Supports)								
Item	Deviation	Causes	Consequences	Matrix	Severity	Likelihood	Risk	Safeguards	Recommendations	Comment
		2. Regular tank use, pressurisation/depressurisation cycle	1. H <sub>2</sub> storage tank liner collapse to be tank blowdown	Asset	1	C	Low	1. Proper manufacturing, system testing, and leak testing of H <sub>2</sub> piping, storage tank, system 2. H <sub>2</sub> Storage Tank Design such that the tank temperature & pressure operating conditions are within the design limits per tank manufacturer's specifications (i.e., 20 bar normal operating pressure) 3. H <sub>2</sub> Storage Tank Design meets ISO leak-before-failure and fatigue criteria 4. H <sub>2</sub> Storage Tank Design meets marine loading criteria and class rules	38. Consult with tank supplier regarding failure modes of the tank (FMECA study) including potential for H <sub>2</sub> storage tank liner collapse during tank blowdown, regular tank pressurisation/depressurisation cycles. 39. Develop operating plan/procedures to verify the H <sub>2</sub> storage tank liner integrity after completing pressurisation. consider keeping a record of tank blowdown events and tank pressurisation cycles.	

No.: 5		H <sub>2</sub> Storage System Location Below Deck (Tanks, Tank Interface, Supports)								
Item	Deviation	Causes	Consequences	Matrix	Severity	Likelihood	Risk	Safeguards	Recommendations	Comment
								5. H <sub>2</sub> Storage Tank Design will be tested for burst failure mode and proper fatigue life 6. Crew routine visual inspection of onboard system and equipment during voyage (i.e., for ice formation) 7. Hydrogen, Fire & Gas (F&G) Detection System monitoring H <sub>2</sub> storage area & bunkering station 8. H <sub>2</sub> leak detection from H <sub>2</sub> storage tank and piping will initiate alarms for operator response and activate ESD system		

No.: 5		H <sub>2</sub> Storage System Location Below Deck (Tanks, Tank Interface, Supports)								
Item	Deviation	Causes	Consequences	Matrix	Severity	Likelihood	Risk	Safeguards	Recommendations	Comment
								9. Pressure transmitters at each H <sub>2</sub> Storage Tank to provide alarms (L, H) and shutdowns (HH) 10. Temperature transmitters at each H <sub>2</sub> Storage Tank to provide alarms (L, H) and shutdowns (HH) 11. Emergency Shutdown System (ESD) of H <sub>2</sub> storage system & bunkering station 12. Blowdown of H <sub>2</sub> inventory in H <sub>2</sub> storage tanks & piping 13. Pressure Relief Valves on H <sub>2</sub> Storage Tank		
			2. Localise delamination with carbon resin	Asset	2	B	Low			
			3. Tank integrity compromised, damage	Asset	3	B	Moderate			

No.: 5		H <sub>2</sub> Storage System Location Below Deck (Tanks, Tank Interface, Supports)								
Item	Deviation	Causes	Consequences	Matrix	Severity	Likelihood	Risk	Safeguards	Recommendations	Comment
			4. H <sub>2</sub> leakage from tank liner (small leak)	Asset	2	B	Low			
5.7	Low temperature in H <sub>2</sub> storage system	1. Bunker system delivering at lower temperature than operating limits	1. Low temperature in H <sub>2</sub> storage system	Asset	2	C	Moderate	1. Proper manufacturing, system testing, and leak testing of H <sub>2</sub> piping, storage tank, system 2. Bunker station, H <sub>2</sub> storage area, and tank connection space are classified and restricted (minimizing personnel exposure in case of emergency and restricted access during bunkering)		

No.: 5		H <sub>2</sub> Storage System Location Below Deck (Tanks, Tank Interface, Supports)								
Item	Deviation	Causes	Consequences	Matrix	Severity	Likelihood	Risk	Safeguards	Recommendations	Comment
								3. Bunkering procedures include thermal image scan for hot spots or overheating before starting, equalizing the bunker lines to bunkering pressure from bunker vessel (250 bar max), and leak testing, and opening the H <sub>2</sub> storage tank valve 5. H <sub>2</sub> Storage Tank Design meets marine loading criteria and class rules 6. H <sub>2</sub> Storage Tank Design will be tested for burst failure mode and proper fatigue life		

No.: 5		H <sub>2</sub> Storage System Location Below Deck (Tanks, Tank Interface, Supports)								
Item	Deviation	Causes	Consequences	Matrix	Severity	Likelihood	Risk	Safeguards	Recommendations	Comment
								7. H <sub>2</sub> leak detection from H <sub>2</sub> storage tank and piping will initiate alarms for operator response and activate ESD system 8. Temperature transmitters TT-001 to monitor temperature at the bunkering station and provide alarms (H, L) and shutdown (HH) 9. Temperature transmitters at each H <sub>2</sub> Storage Tank to provide alarms (L, H) and shutdowns (HH) 10. Emergency Shutdown System (ESD) of H <sub>2</sub> storage system & bunkering station		



No.: 5		H <sub>2</sub> Storage System Location Below Deck (Tanks, Tank Interface, Supports)								
Item	Deviation	Causes	Consequences	Matrix	Severity	Likelihood	Risk	Safeguards	Recommendations	Comment
								11. Monitoring crew to manually initiate emergency system shutdown by activating ESD push buttons in case of emergency		
			2. Equipment damage	Asset	3	B	Moderate			
		2. Atmospheric temperature change	1. Low temperature in H <sub>2</sub> storage system	Asset	2	C	Moderate	1. Proper manufacturing, system testing, and leak testing of H <sub>2</sub> piping, storage tank, system  4. H <sub>2</sub> Storage Tank Design such that the tank temperature & pressure operating conditions are within the design limits per tank manufacturer's specifications (i.e., 20 bar normal operating pressure)	47. Confirm temperature limits with tank supplier for H <sub>2</sub> Storage Tank, considering higher and lower temperatures than design limits.	

No.: 5		H <sub>2</sub> Storage System Location Below Deck (Tanks, Tank Interface, Supports)								
Item	Deviation	Causes	Consequences	Matrix	Severity	Likelihood	Risk	Safeguards	Recommendations	Comment
								5. H <sub>2</sub> Storage Tank Design meets marine loading criteria and class rules 6. H <sub>2</sub> Storage Tank Design will be tested for burst failure mode and proper fatigue life 7. H <sub>2</sub> leak detection from H <sub>2</sub> storage tank and piping will initiate alarms for operator response and activate ESD system 8. Temperature transmitters TT-001 to monitor temperature at the bunkering station and provide alarms (H, L) and shutdown (HH)		

No.: 5		H <sub>2</sub> Storage System Location Below Deck (Tanks, Tank Interface, Supports)								
Item	Deviation	Causes	Consequences	Matrix	Severity	Likelihood	Risk	Safeguards	Recommendations	Comment
								9. Temperature transmitters at each H <sub>2</sub> Storage Tank to provide alarms (L, H) and shutdowns (HH) 10. Emergency Shutdown System (ESD) of H <sub>2</sub> storage system & bunkering station		
			2. Equipment damage	Asset	3	B	Moderate			

5.8	Flooding of H <sub>2</sub> Storage compartment	1. Grounding, tank Damage, Corrosion, Vessel Collision	1. Flooding of H <sub>2</sub> Storage compartment	Asset	3	C	High	<p>1. Bilge system for H<sub>2</sub> storage compartment for small leaks</p> <p>2. Tank support design meet IGF code requirement</p> <p>3. Good navigation practice and training</p> <p>4. Train crew and pilot</p> <p>5. Ferry operate on fix route minimizing accident</p> <p>48. Design tank support and foundation to consider buoyancy effects due to flooding of H<sub>2</sub> Storage compartment.</p> <p>49. For H<sub>2</sub> Storage System location Below Deck, evaluate the appropriate Ingress Protection (IP) rating for electrical equipment and whether it should be gas tight or watertight.</p> <p>50. Determine the minimum functionalities that should be available to make the cargo compartment safe considering the H<sub>2</sub> inventory in case of compartment flooding e.g., blowdown</p> <p>117. Damage and stability criteria to be determine considering tank damage protection</p> <p>118. Emergency procedure are to be developed</p>	<p>- the double bottoms do not extend to the full shell of the ferry, so some areas may have single skin.</p> <p>- from Naval Architecture perspective: the ferry does not have a double bottom since preliminary design shows that it would be 760mm high and this just was not feasible in the plant, fuel cell and switchboard rooms. Since we don't have it throughout the damage stability this is assessed assuming two compartment damage, whereas if it did have a DB then we would only have to consider</p>
-----	--	--	---	-------	---	---	------	--	---

No.: 5		H <sub>2</sub> Storage System Location Below Deck (Tanks, Tank Interface, Supports)								
Item	Deviation	Causes	Consequences	Matrix	Severity	Likelihood	Risk	Safeguards	Recommendations	Comment
										one
			2. Loss of control system	Asset	2	C	Moderate			
			3. Inability to blowdown H <sub>2</sub> storage tanks	Asset	2	C	Moderate			
			4. H <sub>2</sub> tank foundation damage, deformation of supports, misalignment of pipe work	Asset	3	C	High			
			5. Damage to electrical equipment, short-circuiting	Asset	3	C	High			
			6. Vessel grounding, allision (linked to 5.11)							
			7. Tank support breakage due to buoyancy force	Asset	4	B	High			
5.9	Over pressurisation of H <sub>2</sub> storage compartment	1. H <sub>2</sub> leakage upstream of ESDVs to H <sub>2</sub> storage tanks (linked from 5.1)								
5.10	Under pressurisation of H <sub>2</sub> storage compartment (vacuum)	1. Temperature change in weather	1. Under pressurisation of H <sub>2</sub> storage compartment	Asset	2	C	Moderate	1. Pressure vacuum relief protections on H <sub>2</sub> storage tank 2. H <sub>2</sub> tank pressure monitoring system: alarm (H, L) and shutdown (HH) 3.		

No.: 5		H <sub>2</sub> Storage System Location Below Deck (Tanks, Tank Interface, Supports)								
Item	Deviation	Causes	Consequences	Matrix	Severity	Likelihood	Risk	Safeguards	Recommendations	Comment
								4. Proper manufacturing, system testing, and leak testing of H <sub>2</sub> piping, storage tank, system 5. H <sub>2</sub> Storage Tank Design such that the tank temperature & pressure operating conditions are within the design limits per tank manufacturer's specifications (i.e., 20 bar normal operating pressure) 6. H <sub>2</sub> Storage Tank Design meets marine loading criteria and class rules 7. H <sub>2</sub> Storage Tank Design will be tested for burst failure mode and proper fatigue life		

No.: 5		H <sub>2</sub> Storage System Location Below Deck (Tanks, Tank Interface, Supports)								
Item	Deviation	Causes	Consequences	Matrix	Severity	Likelihood	Risk	Safeguards	Recommendations	Comment
								8. Crew routine visual inspection of onboard system and equipment during voyage (i.e., for ice formation) 9. Pressure transmitters at each H <sub>2</sub> Storage Tank to provide alarms (L, H) and shutdowns (HH) 10. Emergency Shutdown System (ESD) of H <sub>2</sub> storage system & bunkering station 11. Monitoring crew to manually initiate emergency system shutdown by activating ESD push buttons in case of emergency 12. Pressure vacuum relief valves on H <sub>2</sub> Storage Tank		

No.: 5		H <sub>2</sub> Storage System Location Below Deck (Tanks, Tank Interface, Supports)								
Item	Deviation	Causes	Consequences	Matrix	Severity	Likelihood	Risk	Safeguards	Recommendations	Comment
								13. Crew is equipped with Personnel Protective Equipment (PPE)		
			2. H <sub>2</sub> storage compartment collapse (vacuum)	Asset	3	B	Moderate			
5.11	Vessel grounding, allision	1. Ferry grounding incident	1. Damage to ferry frame and H <sub>2</sub> tank support	Asset	2	C	Moderate		51. Study the potential for vessel grounding, allision incidents and the resulting damage to the ferry frame, H <sub>2</sub> tank support, equipment, and structural damage. There is also potential for H <sub>2</sub> tank movement and damage, so also consider the impact to tank blowdown mechanisms.	
			2. H <sub>2</sub> tank movement, H <sub>2</sub> tank damage	Asset	3	C	High			
		2. Ferry allision incident <b>Comment:</b> - allision can happen in poor weather, high wind when the vessel strikes a pier structure or a bridge	3. Movement of structures after allision incident	Asset	2	C	Moderate	1. No overhead structures (bridges, cranes) on the designated ferry route	51. Study the potential for vessel grounding, allision incidents and the resulting damage to the ferry frame, H <sub>2</sub> tank support, equipment, and structural damage. There is also potential for H <sub>2</sub> tank movement and damage, so also consider the impact to tank blowdown mechanisms.	
			4. Penetration on the side of ferry	Asset	3	C	High			
			5. Passenger injury	Injury	4	C	Extreme			
			6. Damage to equipment, piping, structure	Asset	4	C	Extreme			



No.: 5		H <sub>2</sub> Storage System Location Below Deck (Tanks, Tank Interface, Supports)								
Item	Deviation	Causes	Consequences	Matrix	Severity	Likelihood	Risk	Safeguards	Recommendations	Comment
		3. Flooding of H <sub>2</sub> Storage compartment (linked from 5.8) <b>Comment:</b> See scenario 5.8 for flooding of H <sub>2</sub> Storage Compartment scenario due to vessel grounding & collision								
5.12	Maintenance/Inspection issues due to tight compartment	1. Tight space in H <sub>2</sub> storage compartment	1. Maintenance/Inspection issues of piping & valves	Asset	2	C	Moderate		52. Develop the maintenance and inspection plan for the equipment inside the H <sub>2</sub> storage compartment during the life of the vessel. Also consider the replacement of H <sub>2</sub> storage tanks.	
			2. Maintenance/Inspection issues of H <sub>2</sub> storage tank	Asset	2	C	Moderate			
5.13	Bunker lines - general recommendations	1. General recommendations to improve design.							53. In case of H <sub>2</sub> storage location below deck, study the bunker line routing and consider double wall designs.	- bunker lines from bunker station to this H <sub>2</sub> Storage location below deck - bunker lines will be double walled
5.14	Egress Routes from space - general recommendations	1. General recommendations to improve design.							54. Conduct further studies on the H <sub>2</sub> storage compartment below deck entry and provide entry from car deck (main deck) and provide appropriate protections for personnel entering the space for inspection or maintenance activities.	- during normal operations, this space is considered unmanned space.

No.: 5		H <sub>2</sub> Storage System Location Below Deck (Tanks, Tank Interface, Supports)								
Item	Deviation	Causes	Consequences	Matrix	Severity	Likelihood	Risk	Safeguards	Recommendations	Comment
									55. Consider in the design that this H <sub>2</sub> storage compartment below deck is to be gas tight.	
5.15	H <sub>2</sub> Tank failure	1. H <sub>2</sub> Tank rupture due to manufacturing defects, excessive heat	1. H <sub>2</sub> Tank damage	Asset	4	B	High	1. Proper manufacturing, system testing, and leak testing of H <sub>2</sub> piping, storage tank, system 2. A60 insulation below the H <sub>2</sub> storage area (bridge deck) & on the main deck (underneath) 3. Blast wall separating the wheelhouse from H <sub>2</sub> storage area * 4. Bunker station, H <sub>2</sub> storage area, and tank connection space are classified and restricted (minimizing personnel exposure in case of emergency and restricted access during bunkering)	38. Consult with tank supplier regarding failure modes of the tank (FMECA study) including potential for H <sub>2</sub> storage tank liner collapse during tank blowdown, regular tank pressurisation/depressurisation cycles. 88. Consider verifying the H <sub>2</sub> storage tank design standard, tank testing, and manufacturing plan from tank supplier to minimise manufacturing defects. Also evaluate the impact of tank rupture on ferry pilot house and structures and evaluate the effectiveness of tank protections. 91. Evaluate the blast wall design considering the potential H <sub>2</sub> tank rupture scenario. If appropriately designed, this can be a safeguard for H <sub>2</sub> Tank rupture scenario.	- CCPV tank rupture incident has occurred in industry, typically during tank charging - 250 bar Type 4 tank design and the # of tanks was selected due to smaller tank sizing and to have the ability to install H <sub>2</sub> tanks in interior space without spacing issues.

No.: 5		H <sub>2</sub> Storage System Location Below Deck (Tanks, Tank Interface, Supports)								
Item	Deviation	Causes	Consequences	Matrix	Severity	Likelihood	Risk	Safeguards	Recommendations	Comment
								5. H <sub>2</sub> Storage Tank foundation & support design will meet IGF code requirements 6. H <sub>2</sub> Storage Tank Design such that the tank temperature & pressure operating conditions are within the design limits per tank manufacturer's specifications (i.e. 20 bar normal operating pressure) 7. H <sub>2</sub> Storage Tank Design meets ISO leak-before-failure and fatigue criteria 8. H <sub>2</sub> Storage Tank Design meets marine loading criteria and class rules		

No.: 5		H <sub>2</sub> Storage System Location Below Deck (Tanks, Tank Interface, Supports)								
Item	Deviation	Causes	Consequences	Matrix	Severity	Likelihood	Risk	Safeguards	Recommendations	Comment
								9. H <sub>2</sub> Storage Tank Design will be tested for burst failure mode and proper fatigue life 10. Monitoring crew to manually initiate emergency system shutdown by activating ESD push buttons in case of emergency 11. Crew routine visual inspection of onboard system and equipment during voyage (i.e., for ice formation) 12. H <sub>2</sub> leak detection from H <sub>2</sub> storage tank and piping will initiate alarms for operator response and activate ESD system		

No.: 5		H <sub>2</sub> Storage System Location Below Deck (Tanks, Tank Interface, Supports)								
Item	Deviation	Causes	Consequences	Matrix	Severity	Likelihood	Risk	Safeguards	Recommendations	Comment
								13. Crew is equipped with Personnel Protective Equipment (PPE)		
			2. Ferry pilot house damage and structural damage	Asset	4	B	High			
			3. Personnel injury	Injury	4	A	High			
		2. leakage from inner liner	4. Gas in tank compartment	Overall	S3-Moderate	LC-Possible	High	1. Proper manufacturing, system testing, and leak testing of H <sub>2</sub> piping, storage tank, system 2. A60 insulation below the H <sub>2</sub> storage area (bridge deck) & on the main deck (underneath)	1. Conduct Fire Hazards Analysis, Gas Dispersion Analysis, Explosion Analysis to establish hazardous area zones and hazardous impact. Provide appropriate mitigations for fire and explosion consequences. Evaluate if the vessel structural damage due to explosion can compromise the damage stability and integrity of the vessel. Evaluate the vent mast design and hazardous area zone established by the vent mast.  38. Consult with tank supplier regarding failure modes of the tank (FMECA study) including potential for H <sub>2</sub> storage tank liner collapse during tank blowdown, regular tank pressurisation/depressurisation cycles.	

No.: 5		H <sub>2</sub> Storage System Location Below Deck (Tanks, Tank Interface, Supports)								
Item	Deviation	Causes	Consequences	Matrix	Severity	Likelihood	Risk	Safeguards	Recommendations	Comment
								4. Bunker station, H <sub>2</sub> storage area, and tank connection space are classified and restricted (minimizing personnel exposure in case of emergency and restricted access during bunkering) 5. H <sub>2</sub> Storage Tank foundation & support design will meet IGF code requirements 6. H <sub>2</sub> Storage Tank Design such that the tank temperature & pressure operating conditions are within the design limits per tank manufacturer's specifications (i.e., 20 bar normal operating pressure)	88. Consider verifying the H <sub>2</sub> storage tank design standard, tank testing, and manufacturing plan from tank supplier to minimise manufacturing defects. Also evaluate the impact of tank rupture on ferry pilot house and structures and evaluate the effectiveness of tank protections. 111. CCPV tank detail FMECA are to be performed	

No.: 5		H <sub>2</sub> Storage System Location Below Deck (Tanks, Tank Interface, Supports)								
Item	Deviation	Causes	Consequences	Matrix	Severity	Likelihood	Risk	Safeguards	Recommendations	Comment
								7. H <sub>2</sub> Storage Tank Design meets ISO leak-before-failure and fatigue criteria 8. H <sub>2</sub> Storage Tank Design meets marine loading criteria and class rules 9. H <sub>2</sub> Storage Tank Design will be tested for burst failure mode and proper fatigue life 10. Monitoring crew to manually initiate emergency system shutdown by activating ESD push buttons in case of emergency 11. Crew routine visual inspection of onboard system and equipment during voyage (i.e., for ice formation)		

No.: 5		H <sub>2</sub> Storage System Location Below Deck (Tanks, Tank Interface, Supports)								
Item	Deviation	Causes	Consequences	Matrix	Severity	Likelihood	Risk	Safeguards	Recommendations	Comment
								12. H <sub>2</sub> leak detection from H <sub>2</sub> storage tank and piping will initiate alarms for operator response and activate ESD system 13. Crew is equipped with Personnel Protective Equipment (PPE)		
			5. Fire/explosion							
5.16	Tank fatigue failure from dome area liner or connections	1. Tank fatigue failure from dome area liner or connections	1. H <sub>2</sub> leakage from H <sub>2</sub> storage tank	Asset	2	C	Moderate	1. Proper manufacturing, system testing, and leak testing of H <sub>2</sub> piping, storage tank, system 2. A60 insulation below the H <sub>2</sub> storage area (bridge deck) & on the main deck (underneath) 3. Blast wall separating the wheelhouse from H <sub>2</sub> storage area *		



No.: 5		H <sub>2</sub> Storage System Location Below Deck (Tanks, Tank Interface, Supports)								
Item	Deviation	Causes	Consequences	Matrix	Severity	Likelihood	Risk	Safeguards	Recommendations	Comment
								4. Bunker station, H <sub>2</sub> storage area, and tank connection space are classified and restricted (minimizing personnel exposure in case of emergency and restricted access during bunkering) 5. H <sub>2</sub> Storage Tank foundation & support design will meet IGF code requirements 6. H <sub>2</sub> Storage Tank Design such that the tank temperature & pressure operating conditions are within the design limits per tank manufacturer's specifications (i.e., 20 bar normal operating pressure)		

No.: 5		H <sub>2</sub> Storage System Location Below Deck (Tanks, Tank Interface, Supports)								
Item	Deviation	Causes	Consequences	Matrix	Severity	Likelihood	Risk	Safeguards	Recommendations	Comment
								7. H <sub>2</sub> Storage Tank Design meets ISO leak-before-failure and fatigue criteria 8. H <sub>2</sub> Storage Tank Design meets marine loading criteria and class rules 9. Monitoring crew to manually initiate emergency system shutdown by activating ESD push buttons in case of emergency 10. Crew routine visual inspection of onboard system and equipment during voyage (i.e., for ice formation)		

No.: 5		H <sub>2</sub> Storage System Location Below Deck (Tanks, Tank Interface, Supports)								
Item	Deviation	Causes	Consequences	Matrix	Severity	Likelihood	Risk	Safeguards	Recommendations	Comment
								11. H <sub>2</sub> leak detection from H <sub>2</sub> storage tank and piping will initiate alarms for operator response and activate ESD system 12. Crew is equipped with Personnel Protective Equipment (PPE)		
			2. Fire	Overall	S3-Moderate	LB-Unlikely	Moderate			
			3. Explosion	Overall	S3-Moderate	LB-Unlikely	Moderate			
5.17	Vibration issues	1. Ship vibration impacting H <sub>2</sub> piping and connections	1. H <sub>2</sub> leakage	Asset	2	C	Moderate	1. Proper manufacturing, system testing, and leak testing of H <sub>2</sub> piping, storage tank, system 2. A60 insulation below the H <sub>2</sub> storage area (bridge deck) & on the main deck (underneath)	89. Consider conducting a vibration study on the concept design to understand the impact of vibration issues on H <sub>2</sub> piping and connections which may lead to H <sub>2</sub> leakage hazards. 90. Discuss H <sub>2</sub> system threaded connections acceptance with class and regulators. 119. Consider all piping to meet leak-before-fail criteria	- new technology in marine environment may introduce vibration issues

No.: 5		H <sub>2</sub> Storage System Location Below Deck (Tanks, Tank Interface, Supports)								
Item	Deviation	Causes	Consequences	Matrix	Severity	Likelihood	Risk	Safeguards	Recommendations	Comment
								3. Blast wall separating the wheelhouse from H <sub>2</sub> storage area * 4. Bunker station, H <sub>2</sub> storage area, and tank connection space are classified and restricted (minimizing personnel exposure in case of emergency and restricted access during bunkering) 5. H <sub>2</sub> Storage Tank foundation & support design will meet IGF code requirements		

No.: 5		H <sub>2</sub> Storage System Location Below Deck (Tanks, Tank Interface, Supports)								
Item	Deviation	Causes	Consequences	Matrix	Severity	Likelihood	Risk	Safeguards	Recommendations	Comment
								6. H <sub>2</sub> Storage Tank Design such that the tank temperature & pressure operating conditions are within the design limits per tank manufacturer's specifications (i.e., 20 bar normal operating pressure) 7. H <sub>2</sub> Storage Tank Design meets ISO leak-before-failure and fatigue criteria 8. H <sub>2</sub> Storage Tank Design meets marine loading criteria and class rules 9. H <sub>2</sub> Storage Tank Design will be tested for burst failure mode and proper fatigue life		

No.: 5		H <sub>2</sub> Storage System Location Below Deck (Tanks, Tank Interface, Supports)								
Item	Deviation	Causes	Consequences	Matrix	Severity	Likelihood	Risk	Safeguards	Recommendations	Comment
								10. Monitoring crew to manually initiate emergency system shutdown by activating ESD push buttons in case of emergency 11. Crew routine visual inspection of onboard system and equipment during voyage (i.e., for ice formation) 12. H <sub>2</sub> leak detection from H <sub>2</sub> storage tank and piping will initiate alarms for operator response and activate ESD system 13. Crew is equipped with Personnel Protective Equipment (PPE)		
			2. Equipment damage	Asset	3	B	Moderate			

No.: 5		H <sub>2</sub> Storage System Location Below Deck (Tanks, Tank Interface, Supports)								
Item	Deviation	Causes	Consequences	Matrix	Severity	Likelihood	Risk	Safeguards	Recommendations	Comment
			3. Fire	Overall	S4-Major	LB-Unlikely	High			
			4. Explosion	Overall	S4-Major	LB-Unlikely	High			

6	H <sub>2</sub> Supply System & Piping
<p>Section notes:</p> <ul style="list-style-type: none"> <li>-location below deck double wall piping between the H<sub>2</sub> storage tanks and pressure reduction station.</li> <li>- for both proposed H<sub>2</sub> storage locations (1. location on wheelhouse deck, and 2. location below deck), assumes that the double wall piping from pressure reduction station to fuel cell system inlet,</li> </ul> <p>- H<sub>2</sub> Supply System: from ESDV-008 (isolating H<sub>2</sub> supply from H<sub>2</sub> manifold) to a pressure reduction station, then to ESDV-014 before routing to the fuel cell system</p> <ul style="list-style-type: none"> <li>- pressure reduction station is in parallel configuration to provide redundancy for pressure reduction</li> <li>- there is also a master fuel supply valve inside each Fuel Cell module</li> </ul> <p>Two stage pressure reduction PCV 002 to PCV 005 Each tank has its own supply valve at manifold</p>	

No.: 6		H <sub>2</sub> Supply System & Piping								
Item	Deviation	Causes	Consequences	Matrix	Severity	Likelihood	Risk	Safeguards	Recommendations	Comment
6.1	General recommendations	1. General recommendations to improve design.							58. Consider providing a fuel isolation valve at the H <sub>2</sub> fuel inlet to each Fuel Cell Module per type approval requirements.	
6.2	High pressure downstream of Pressure Reduction Station	1. On line Pressure Reduction Valve malfunctions	1. Higher pressure than design limits downstream of Pressure Reduction Station	Asset	1	C	Low	1. Control system switch over to standby Pressure Reduction Valve after the online valve malfunctions 2. Proper manufacturing, system testing, and leak testing of H <sub>2</sub> piping, storage tank, system 3. System design such that all piping is welded with no joints or connections (minimizing H <sub>2</sub> leakages)	11. Conduct detailed HAZOP at later engineering phase when system details (C&E Chart, P&IDs) are available H <sub>2</sub> storage system, Fuel Cell, etc. 59. Develop the overall Cause & Effects charts and integrate the Cause & Effect charts from Fuel Cell system.	- 2 pressure reduction valves, one on line and one on standby - H <sub>2</sub> supply design pressure: 2.5 to 6.5 bar (Fuel Cell supplier spec) - H <sub>2</sub> supply design temperature: 0 to 80 degC (Fuel Cell supplier spec)



No.: 6		H <sub>2</sub> Supply System & Piping								
Item	Deviation	Causes	Consequences	Matrix	Severity	Likelihood	Risk	Safeguards	Recommendations	Comment
								4. Hydrogen, Fire & Gas (F&G) Detection System monitoring H <sub>2</sub> storage area & bunkering station 5. H <sub>2</sub> leak detection from H <sub>2</sub> storage tank and piping will initiate alarms for operator response and activate ESD system 6. Pressure transmitter PIA-012 at the H <sub>2</sub> supply line to provide alarms (H, L) and shutdowns (HH) 7. Pressure transmitter PIA-013/014/015 at each H <sub>2</sub> inlet to Fuel Cell Modules to provide alarms (H, L) and shutdowns (HH) 8. Emergency Shutdown System (ESD) of H <sub>2</sub> storage system & bunkering station 9. Pressure Relief System on H <sub>2</sub> supply piping (21-PR-01) to Fuel Cell system to relieve pressure 10. Two stage pressure reduction 11. Double wall piping	60. Verify the ferry operating conditions including H <sub>2</sub> storage temperatures in various weather conditions considering the atmospheric conditions. Consider conducting fluid study to verify that H <sub>2</sub> supply system can meet the design temperature range for Fuel Cell system.	

No.: 6		H <sub>2</sub> Supply System & Piping								
Item	Deviation	Causes	Consequences	Matrix	Severity	Likelihood	Risk	Safeguards	Recommendations	Comment
								12. F&G inside Fuel Cell room		
			2. Fuel Cell damage	Asset	3	B	Moderate			
			3. H <sub>2</sub> piping damage	Asset	3	B	Moderate			
6.3	H <sub>2</sub> piping inner wall damage	1. Piping Fatigue, piping overload	1. N <sub>2</sub> leakage into H <sub>2</sub> inner piping (annulus maintain at higher pressure compared to H <sub>2</sub> )	Asset	1	C	Low	1. Proper manufacturing, system testing, and leak testing of H <sub>2</sub> piping, storage tank, system 2. System design such that the annulus piping (N <sub>2</sub> ) is maintained at higher pressure than inner piping space (H <sub>2</sub> ) 3. Pressure transmitters to monitor H <sub>2</sub> piping and piping annulus space (N <sub>2</sub> ) 4. H <sub>2</sub> leak detection from H <sub>2</sub> storage tank and piping will initiate alarms for operator response and activate ESD system 5. Pressure transmitter PIA-013/014/015 at each H <sub>2</sub> inlet to Fuel Cell Modules to provide alarms (H, L) and shutdowns (HH) 6. Emergency Shutdown System (ESD) of H <sub>2</sub> storage system & bunkering station	61. Consider providing detection mechanisms to detect H <sub>2</sub> piping damage since the current N <sub>2</sub> supply system is not monitoring for small N <sub>2</sub> leaks which can migrate into H <sub>2</sub> inner piping space. 62. Consider hot testing as part of Fuel Cell System startup operating procedures since there is no means to detect leaks in the H <sub>2</sub> piping annulus and the annulus is inerted with N <sub>2</sub> . Hot testing is to detect inner piping leaks in the H <sub>2</sub> supply piping.	- double wall piping with N <sub>2</sub> inerting - piping is all welded, no joints or connections - since the principle is to maintain annulus pressure (N <sub>2</sub> ) higher than the H <sub>2</sub> pressure in the inner piping space. N <sub>2</sub> leakage into H <sub>2</sub> piping is more credible. - N <sub>2</sub> mixture with H <sub>2</sub> supply to Fuel Cell is not expected to damage Fuel Cell system.

No.: 6		H <sub>2</sub> Supply System & Piping								
Item	Deviation	Causes	Consequences	Matrix	Severity	Likelihood	Risk	Safeguards	Recommendations	Comment
			2. Damage to H <sub>2</sub> Piping outer wall	Asset	3	B	Moderate			
		2. Pitting corrosion in Stainless Steel piping due to marine environment	1. N <sub>2</sub> leakage into H <sub>2</sub> inner piping (annulus maintain at higher pressure compared to H <sub>2</sub> )	Asset	1	C	Low	1. Proper manufacturing, system testing, and leak testing of H <sub>2</sub> piping, storage tank, system 2. System design such that the annulus piping (N <sub>2</sub> ) is maintained at higher pressure than inner piping space (H <sub>2</sub> ) 3. Pressure transmitters to monitor H <sub>2</sub> piping and piping annulus space (N <sub>2</sub> ) 4. H <sub>2</sub> leak detection from H <sub>2</sub> storage tank and piping will initiate alarms for operator response and activate ESD system 5. Pressure transmitter PIA-013/014/015 at each H <sub>2</sub> inlet to Fuel Cell Modules to provide alarms (H, L) and shutdowns (HH) 6. Emergency Shutdown System (ESD) of H <sub>2</sub> storage system & bunkering station	63. Develop protocol and quality control requirements to properly weld Stainless Steel (SS316) H <sub>2</sub> piping to prevent pitting corrosions due to marine environment. This is a known issue in SS piping.	
			2. Damage to H <sub>2</sub> Piping outer wall	Asset	3	B	Moderate			

No.: 6		H <sub>2</sub> Supply System & Piping								
Item	Deviation	Causes	Consequences	Matrix	Severity	Likelihood	Risk	Safeguards	Recommendations	Comment
6.4	H <sub>2</sub> piping outer wall damage	1. Piping Fatigue, piping overload	2. Damage to H <sub>2</sub> Piping outer wall (N <sub>2</sub> )	Asset	2	C	Moderate	1. Proper manufacturing, system testing, and leak testing of H <sub>2</sub> piping, storage tank, system 2. Pressure transmitters to monitor H <sub>2</sub> piping and piping annulus space (N <sub>2</sub> ) 3. Fuel Cell space is classified as Category A machinery space and continuously ventilated with 30 air changes/hour 4. Oxygen detector AQA-005 to provide alarm (L) and shutdown (LL) 6. H <sub>2</sub> leak detection from H <sub>2</sub> storage tank and piping will initiate alarms for operator response and activate ESD system 7. Emergency Shutdown System (ESD) of H <sub>2</sub> storage system & bunkering station	61. Consider providing detection mechanisms to detect H <sub>2</sub> piping damage since the current N <sub>2</sub> supply system is not monitoring for small N <sub>2</sub> leaks which can migrate into H <sub>2</sub> inner piping space. 64. Conduct further study to determine N <sub>2</sub> leakage from H <sub>2</sub> piping annulus to surrounding space due to outer wall piping damage or consider monitoring the N <sub>2</sub> supply flow rate to provide early detection of N <sub>2</sub> leakages. 65. Develop periodic inspections and test plans for the H <sub>2</sub> piping to detect inner wall and outer wall damage. Piping connections are to be checked periodically to identify potential leak points.	- H <sub>2</sub> piping: N <sub>2</sub> in annulus, H <sub>2</sub> in inner wall - H <sub>2</sub> piping is not passing through occupied spaces
			3. N <sub>2</sub> leak into Fuel Cell space or passing space	Asset	2	C	Moderate			
			4. Loss of N <sub>2</sub> pressure in H <sub>2</sub> piping annulus	Asset	2	C	Moderate			
			5. Personnel asphyxiation due to N <sub>2</sub> rich environment	Injury	4	B	High			

No.: 6		H <sub>2</sub> Supply System & Piping								
Item	Deviation	Causes	Consequences	Matrix	Severity	Likelihood	Risk	Safeguards	Recommendations	Comment
		2. Pitting corrosion in Stainless Steel piping due to marine environment	2. Damage to H <sub>2</sub> Piping outer wall (N <sub>2</sub> )	Asset	2	C	Moderate	1. Proper manufacturing, system testing, and leak testing of H <sub>2</sub> piping, storage tank, system 2. Pressure transmitters to monitor H <sub>2</sub> piping and piping annulus space (N <sub>2</sub> ) 3. Fuel Cell space is classified as Category A machinery space and continuously ventilated with 30 air changes/hour 4. Oxygen detector AQA-005 to provide alarm (L) and shutdown (LL) 6. H <sub>2</sub> leak detection from H <sub>2</sub> storage tank and piping will initiate alarms for operator response and activate ESD system 7. Emergency Shutdown System (ESD) of H <sub>2</sub> storage system & bunkering station	63. Develop protocol and quality control requirements to properly weld Stainless Steel (SS316) H <sub>2</sub> piping to prevent pitting corrosions due to marine environment. This is a known issue in SS piping.	
			3. N <sub>2</sub> leak into Fuel Cell space or passing space	Asset	2	C	Moderate			
			4. Loss of N <sub>2</sub> pressure in H <sub>2</sub> piping annulus	Asset	2	C	Moderate			
			5. Personnel asphyxiation due to N <sub>2</sub> rich environment	Injury	4	B	High			

No.: 6		H <sub>2</sub> Supply System & Piping								
Item	Deviation	Causes	Consequences	Matrix	Severity	Likelihood	Risk	Safeguards	Recommendations	Comment
		3. Dropped Object incident (overhead lifting above double wall piping) <b>Comment:</b> - potential damage to piping during lifting operations, with handling arrangements TBD.	1. Damage to H <sub>2</sub> Piping inner wall (H <sub>2</sub> )	Asset	1	C	Low	1. Proper manufacturing, system testing, and leak testing of H <sub>2</sub> piping, storage tank, system 2. Pressure transmitters to monitor H <sub>2</sub> piping and piping annulus space (N <sub>2</sub> ) 3. Fuel Cell space is classified as Category A machinery space and continuously ventilated with 30 air changes/hour 4. Oxygen detector AQA-005 to provide alarm (L) and shutdown (LL) 5. H <sub>2</sub> piping will be routed at the base of the Fuel Cell Module and underneath a grated plate 6. H <sub>2</sub> leak detection from H <sub>2</sub> storage tank and piping will initiate alarms for operator response and activate ESD system 7. Emergency Shutdown System (ESD) of H <sub>2</sub> storage system & bunkering station	17. Develop operational procedures to ensure no overhead lifting when Fuel Cell system is running with H <sub>2</sub> supply and have restrictions in place to prevent dropped object impact on H <sub>2</sub> storage system, H <sub>2</sub> piping and H <sub>2</sub> bunkering lines.	
			2. Damage to H <sub>2</sub> Piping outer wall (N <sub>2</sub> )	Asset	2	C	Moderate			

No.: 6		H <sub>2</sub> Supply System & Piping								
Item	Deviation	Causes	Consequences	Matrix	Severity	Likelihood	Risk	Safeguards	Recommendations	Comment
			3. N <sub>2</sub> leak into Fuel Cell space or passing space	Asset	2	C	Moderate			
			4. Loss of N <sub>2</sub> pressure in H <sub>2</sub> piping annulus	Asset	2	C	Moderate			
			5. Personnel asphyxiation due to N <sub>2</sub> rich environment	Injury	4	B	High			
			6. Fire	Overall	S4-Major	LB-Unlikely	High			
			7. Explosion	Overall	S3-Moderate	LB-Unlikely	Moderate			
6.5	Emergency Shutdown of H <sub>2</sub> supply to Fuel Cell system - general recommendations	1. General recommendation to improve design.							66. Evaluate the Fuel Cell system separately in a risk assessment and consider the risks when integrating the system in the ferry design. For example, consider potential risks in cathode and anode outlets of Fuel Cell system. 67. Develop mechanisms to collect and dispose of produced deionised water from Fuel Cell system onboard the ferry.	- low pressure H <sub>2</sub> inventory - no automatic purging proposed currently. Vessel master will make decision on when to purge the H <sub>2</sub> piping. - Fuel Cell space is Category A machinery space with ventilation rate of 30 air changes/hour

7	Fuel Cell System
<p>Section notes:</p> <ul style="list-style-type: none"> <li>- relatively high (issue clashing with deck height?)</li> <li>- Proton Exchange Membrane (PEM) type</li> <li>- consumes 14 kg of H<sub>2</sub>/hour @ 200 kW (10 bottles at 32 kg/bottle, so sufficient for 1 day)</li> <li>- 2 Fuel Cell systems</li> <li>- 300 kW fuel cell units with separate fuel cell rooms and redundancies</li> <li>- liquid cooled</li> <li>- gas tight bulkhead between 2 fuel cell rooms, exhaust funnel will be routed to starboard side</li> </ul>	



No.: 7		Fuel Cell System									
Item	Deviation	Causes	Consequences	Matrix	Severity	Likelihood	Risk	Safeguards	Recommendations	Comment	
7.1	General recommendations	1. General recommendations to improve design.							<p>68. Fuel Cell system selection design is still under development. When more details are available, consider conducting an integration risk assessment (i.e. HAZID) to integrate the Fuel Cell system with the ferry design.</p> <p>69. When there are two Fuel Cell rooms in the center of the ferry, exhaust and vent design is to be evaluated when more details are available.</p> <p>70. Once a Fuel Cell supplier is selected and design is confirmed, select the appropriate firefighting philosophy for the Fuel Cell room and provide appropriate firefighting mechanisms.</p> <p>71. Once a Fuel Cell supplier is selected and design is confirmed, confirm system type approval and hazardous area classification of the Fuel Cell Room with class, and relevant class rules, i.e., air locks for hazardous area entry or Fuel Cell Room exhaust design, to be provided.</p>	<p>Fuel Cell System:</p> <ul style="list-style-type: none"> <li>- relatively high (issue clashing with deck height?)</li> <li>- Proton Exchange Membrane (PEM) type, 2 Fuel Cell units</li> <li>- consumes 14 kg of H<sub>2</sub>/hour @ 200 kW (10 bottles at 32 kg/bottle, so sufficient for 1 day)</li> <li>- 300 kW fuel cell units in one space with system redundancies</li> <li>- liquid cooled</li> <li>- Fuel Cell room is gas tight boundary with A60 fire rating</li> <li>- Fuel Cell Room exhaust funnel will be routed to starboard side</li> <li>- Fuel Cell Room will be Class A machinery space with A-60 fire rating</li> <li>- for each Fuel Cell unit, the unit is gas tight, with connections in the bottom</li> <li>- if the Fuel Cell room is classified as a hazardous space, air locks for Fuel Cell Room entry will be provided.</li> <li>- air supply from a safe area from deck, with salt filter installed</li> </ul>	

8	Li-ion Battery System
Li-ion Battery System	

No.: 8		Li-ion Battery System									
Item	Deviation	Causes	Consequences	Matrix	Severity	Likelihood	Risk	Safeguards	Recommendations	Comment	
8.1	General recommendations	1. General recommendations to improve design.							72. Once a Li-ion battery system design and supplier are selected, conduct an integration risk assessment (HAZID) to verify design details with ferry design. 73. Once a Li-ion battery system design and supplier are selected, develop battery room ventilation design, battery cooling system (air or liquid cool), firefighting philosophy, Li-ion battery hazards (thermal runaway issues), charging and monitoring of the batteries, location of battery room vents. 74. Once a Li-ion battery system design and supplier are selected, confirm the hazardous area classification with class and system redundancies. 92. Conduct simulation and testing on the Battery system to ensure there is enough battery power available for various ferry operating modes.	- Lithium Ion Battery system is TBD, supplier to be selected - 124 kWh, 3 battery racks in each space, 372 kW total -2 battery rooms: FWD battery room & AFT battery room - both rooms are zone 2 with zone 1 surrounding - air conditioned with minimal air changes/hour, closed circulation - H <sub>2</sub> detector in the room - upon H <sub>2</sub> detection, shutdown ventilation system, activate firefighting system - room will have: emergency vent, exhaust vent - Battery Management System will monitor battery system for thermal runaway hazards	

No.: 8		Li-ion Battery System								
Item	Deviation	Causes	Consequences	Matrix	Severity	Likelihood	Risk	Safeguards	Recommendations	Comment
									93. Consider emergency power arrangement for the ferry operations and comply with class rules.	

9	Electrical Systems
Electrical Systems	

No.: 9		Electrical Systems								
Item	Deviation	Causes	Consequences	Matrix	Severity	Likelihood	Risk	Safeguards	Recommendations	Comment
9.1	General Recommendations	1. General Recommendations							4. Electrical groundings are to be provided for both shore and ship bunkering. 11. Conduct detailed HAZOP at later engineering phase when system details (C&E Chart, P&IDs) are available H <sub>2</sub> storage system, Fuel Cell, etc. 66. Evaluate the Fuel Cell system separately in a risk assessment and consider the risks when integrating the system in the ferry design. For example, consider potential risks in cathode and anode outlets of Fuel Cell system. 68. Fuel Cell system selection design is still under development. When more details are available, consider conducting a integration risk assessment (i.e. HAZID) to integrate Fuel Cell system with the ferry design.	- Fuel Cell system supply primary power for ferry propulsion - Lithium-Ion Battery system will be used for load sharing - Switchboard room between the Fuel Cell Room and FWD Battery Room

No.: 9		Electrical Systems								
Item	Deviation	Causes	Consequences	Matrix	Severity	Likelihood	Risk	Safeguards	Recommendations	Comment
									72. Once a Li-ion battery system design and supplier are selected, conduct an integration risk assessment (HAZID) to verify design details with ferry design.	

10	Ventilation System (H <sub>2</sub> Storage, Fuel Cell Room, Battery Room)
Ventilation System (H <sub>2</sub> Storage, Fuel Cell Room, Battery Room)	

<b>No.:</b> 10		Ventilation System (H <sub>2</sub> Storage, Fuel Cell Room, Battery Room)								
Item	Deviation	Causes	Consequences	Matrix	Severity	Likelihood	Risk	Safeguards	Recommendations	Comment
10.1	General recommendations	1. General recommendations to improve design							80. Consult with Fuel Cell and Battery system suppliers to develop the ventilation system details and ensure that the system meets IGF code. Ventilation system air inlet and outlet are to comply with IGF code requirements.	- ventilation system details TBD

11	Venting System & Vents

No.: 11		Venting System & Vents								
Item	Deviation	Causes	Consequences	Matrix	Severity	Likelihood	Risk	Safeguards	Recommendations	Comment
11.1	General Recommendations	1. General Recommendations to improve design.							1. Conduct Fire Hazards Analysis, Gas Dispersion Analysis, Explosion Analysis to establish hazardous area zones and hazardous impact. Provide appropriate mitigations for fire and explosion consequences. Evaluate if the vessel structural damage due to explosion can compromise the damage stability and integrity of the vessel. Evaluate the vent mast design and hazardous area zone established by the vent mast.  78. Develop details of the vent and venting system design at a later stage. Evaluate if the vent mast needs to be purged with N <sub>2</sub> and provide sufficient N <sub>2</sub> supply. Further risk assessment to be conducted on detailed vent mast design.  79. Per IGF code, provide separation of the inlet and outlet of hazardous areas.	- Venting system design TBD - Venting of H <sub>2</sub> lines and H <sub>2</sub> bottle relief valves will be routed to the H <sub>2</sub> vent mast - TBD: independent release of each H <sub>2</sub> bottle or ability to do simultaneous release of H <sub>2</sub> bottles - Gas Dispersion study was conducted, but quantitative risk assessment to be conducted to understand the probability of the events - vent mast design TBD - vent mast height, and hazardous area sizing TBD

No.: 11		Venting System & Vents								
Item	Deviation	Causes	Consequences	Matrix	Severity	Likelihood	Risk	Safeguards	Recommendations	Comment
									97. Venting philosophy for trapped inventory to be developed after ESD or small leakage in piping, manifold etc. 98. Pressure relief system High pressure / Low pressure are to be separated to avoid any back pressure/reverse flow issue. 99. Relief vent lined are to design to avoid any air ingress to avoid any explosion in relief lines	
11.2	Air in vent mast	1. Air in vent mast with H <sub>2</sub> mixture <b>Comment:</b> - air and H <sub>2</sub> mixture in vent mast may need an ignition source (i.e., lightning, thunderstorm) to result in fire or flashback explosion in the vent mast. This may be a low likelihood event, but the scenario is credible in the oil and gas process industry.	1. Fire in vent mast	Overall	S4-Major	LB-Unlikely	High	1. Crew routine visual inspection of onboard system and equipment during voyage (i.e., for ice formation) 2. Monitoring crew to manually initiate emergency system shutdown by activating ESD push buttons in case of emergency	1. Conduct Fire Hazards Analysis, Gas Dispersion Analysis, Explosion Analysis to establish hazardous area zones and hazardous impact. Provide appropriate mitigations for fire and explosion consequences. Evaluate if the vessel structural damage due to explosion can compromise the damage stability and integrity of the vessel. Evaluate the vent mast design and hazardous area zone established by the vent mast.	



No.: 11		Venting System & Vents								
Item	Deviation	Causes	Consequences	Matrix	Severity	Likelihood	Risk	Safeguards	Recommendations	Comment
									78. Develop details of the vent and venting system design at a later stage. Evaluate if the vent mast needs to be purged with N <sub>2</sub> and provide sufficient N <sub>2</sub> supply. Further risk assessment to be conducted on detailed vent mast design. 84. Provide proper detection for leakage (i.e., from pressure relief valve, blowdown valve) in the vent and vent mast system. 120. Consider vent mast design to withstand internal deflagration/detonation, and to be welded construction	
			2. Flashback explosion in vent mast	Overall	S4-Major	LB-Unlikely	High			
11.3	Venting system leakages	1. Pressure relief valve leakage from H <sub>2</sub> system	1. Loss of H <sub>2</sub> fuel	Asset	2	B	Low	1. Crew routine visual inspection of onboard system and equipment during voyage (i.e., for ice formation) 2. Monitoring crew to manually initiate emergency system shutdown by activating ESD push buttons in case of emergency	84. Provide proper detection for leakage (i.e., from pressure relief valve, blowdown valve) in the vent and vent mast system. 85. Due to a potential leakage from relief and blowdown valves, develop proper valve inspection and maintenance plan.	
			2. Hazardous atmosphere inside vent mast	Asset	3	B	Moderate			

No.: 11		Venting System & Vents								
Item	Deviation	Causes	Consequences	Matrix	Severity	Likelihood	Risk	Safeguards	Recommendations	Comment
		2. Blowdown valve leakage from H <sub>2</sub> system	1. Loss of H <sub>2</sub> fuel	Asset	2	B	Low	1. Crew routine visual inspection of onboard system and equipment during voyage (i.e., for ice formation) 2. Monitoring crew to manually initiate emergency system shutdown by activating ESD push buttons in case of emergency	84. Provide proper detection for leakage (i.e., from pressure relief valve, blowdown valve) in the vent and vent mast system. 85. Due to a potential leakage from relief and blowdown valves, develop proper valve inspection and maintenance plan.	
			2. Hazardous atmosphere inside vent mast	Asset	3	B	Moderate			

12	Cooling System
Cooling System	

<b>No.:</b> 12		Cooling System								
Item	Deviation	Causes	Consequences	Matrix	Severity	Likelihood	Risk	Safeguards	Recommendations	Comment
12.1	General Recommendation	1. General Recommendations to improve design.							81. When more details are available for the Cooling System, discuss any related hazards in a HAZOP at a later detail design stage.	

13	Safety System (ESD & Isolation, Pressure Relief, F&G Detection)
Safety System (ESD & Isolation, Pressure Relief, F&G Detection)	

<b>No.:</b> 13		Safety System (ESD & Isolation, Pressure Relief, F&G Detection)								
Item	Deviation	Causes	Consequences	Matrix	Severity	Likelihood	Risk	Safeguards	Recommendations	Comment
13.1	General Recommendations	1. General Recommendations to improve design							11. Conduct detailed HAZOP at later engineering phase when system details (C&E Chart, P&IDs) are available H <sub>2</sub> storage system, Fuel Cell, etc.  83. Provide appropriate fire & gas detection system, Emergency Shutdown and Isolation philosophy, pressure relief are to be developed at a later design stage. Consult with Fuel Cell and Battery suppliers.	- H <sub>2</sub> , Fire & Gas Detection system, details, and detector layout TBD

14	Firefighting Systems
Firefighting Systems	

No.: 14		Firefighting Systems								
Item	Deviation	Causes	Consequences	Matrix	Severity	Likelihood	Risk	Safeguards	Recommendations	Comment
14.1	No significant issue identified at this stage.	1. No significant issue identified at this stage. Firefighting system philosophy and design will meet IGF code and class rules. other firefighting systems to be determined based on Fuel Cell and Battery supplier's recommendations.								<ul style="list-style-type: none"> <li>- firefighting system to meet IGF code and class rules</li> <li>- water spray system with sufficient water capacity</li> <li>- other firefighting systems to be determined based on Fuel Cell and Battery supplier's recommendations</li> </ul>

15	Other Vessel Operations (SIMOPS, Hazards in Port)
Other Vessel Operations (SIMOPS, Hazards in Port, Bunkering)	

No.: 15		Other Vessel Operations (SIMOPS, Hazards in Port)								
Item	Deviation	Causes	Consequences	Matrix	Severity	Likelihood	Risk	Safeguards	Recommendations	Comment
15.1	H <sub>2</sub> leakage during embarkation & de-embarkation	1. H <sub>2</sub> leakage	1. Fire from H <sub>2</sub> system	Overall	S4-Major	LB-Unlikely	High	1. Proper manufacturing, system testing, and leak testing of H <sub>2</sub> piping, storage tank, system 2. A60 insulation below the H <sub>2</sub> storage area (bridge deck) & on the main deck (underneath) 3. Bunker station, H <sub>2</sub> storage area, and tank connection space are classified and restricted (minimizing personnel exposure in case of emergency and restricted access during bunkering) 4. System design such that H <sub>2</sub> volume is very low in the line, minimizing the severity of release 5. System design such that all piping are welded with no joints or connections (minimizing H <sub>2</sub> leakages) 6. Hydrogen, Fire & Gas (F&G) Detection System monitoring H <sub>2</sub> storage area & bunkering station	87. Develop emergency procedures in case of H <sub>2</sub> leakage during passenger and vehicle embarkation and de-embarkation.	- during vehicle loading and passenger embarkation, there is no expected shore power hookup and Fuel Cell system will be online.

No.: 15		Other Vessel Operations (SIMOPS, Hazards in Port)								
Item	Deviation	Causes	Consequences	Matrix	Severity	Likelihood	Risk	Safeguards	Recommendations	Comment
								7. H <sub>2</sub> leak detection from H <sub>2</sub> storage tank and piping will initiate alarms for operator response and activate ESD system 8. Pressure transmitters at each H <sub>2</sub> Storage Tank to provide alarms (L, H) and shutdowns (HH) 9. Emergency Shutdown System (ESD) of H <sub>2</sub> storage system & bunkering station 10. Monitoring crew to manually initiate emergency system shutdown by activating ESD push buttons in case of emergency 11. Blowdown of H <sub>2</sub> inventory in H <sub>2</sub> storage tanks & piping 12. Pressure Relief Valves on H <sub>2</sub> Storage Tank 13. Firefighting system: activation of water sprays in case of fire onboard		
			2. Personnel exposure to H <sub>2</sub> (low likelihood, due to area restriction)	Injury	4	B	High			

16	Testing, Maintenance, & Inspection
Testing, Maintenance, & Inspection	

<b>No.:</b> 16		Testing, Maintenance, & Inspection								
Item	Deviation	Causes	Consequences	Matrix	Severity	Likelihood	Risk	Safeguards	Recommendations	Comment
16.1	General Recommendations	1. General Recommendations to improve design.							86. Develop detailed test, inspection, and maintenance plan for the H <sub>2</sub> storage tank, H <sub>2</sub> piping according to local regulations, marine regulations, and class rules. Based on selected arrangements for H <sub>2</sub> storage and H <sub>2</sub> piping. Consult with Fuel Cell and Battery system supplier to develop maintenance & inspection plan for these systems.	



17	Emergency Escape, Evacuation, and Rescue
Emergency Escape	

No.: 17		Emergency Escape, Evacuation, and Rescue								
Item	Deviation	Causes	Consequences	Matrix	Severity	Likelihood	Risk	Safeguards	Recommendations	Comment
17.1	General Recommendations	1. General Recommendations to improve design							82. Conduct assessment on Emergency Escape, Evacuation, and Rescue (EER) provisions when more details are available considering potential hazards such as from H <sub>2</sub> storage tank, vehicle fire, smoke impacting escape routes. Verify that EER provisions satisfies SOLAS and applicable local regulations.	<ul style="list-style-type: none"> <li>- H<sub>2</sub> systems are located on ferry port side</li> <li>- Passengers areas are located on starboard side</li> <li>- life rafts will be available and release from the storage area from upper deck, but routes from passenger area to life rafts locations are to be discussed</li> <li>- passenger will access the lift rafts on the main deck</li> <li>- POB: 120 passengers + 4 crew</li> <li>-life rafts: three 100-person rafts, one 50-person raft on port side</li> <li>- one rescue boat.</li> </ul>

No.: 17		Emergency Escape, Evacuation, and Rescue								
Item	Deviation	Causes	Consequences	Matrix	Severity	Likelihood	Risk	Safeguards	Recommendations	Comment
17.2	Passenger escape from starboard to port side during emergency	1. Passenger escape from starboard to port side during emergency	1. Passenger unable to cross over due to hazard location (H <sub>2</sub> storage on bridge deck)	Injury	3	C	High		82. Conduct assessment on Emergency Escape, Evacuation, and Rescue (EER) provisions when more details are available considering potential hazards such as from H <sub>2</sub> storage tank, vehicle fire, smoke impacting escape routes. Verify that EER provisions satisfies SOLAS and applicable local regulations.	

18	Terminal Bunker Delivery
<p>The ferry will be bunkered at a dedicated terminal, which will have compressed storage of H<sub>2</sub>. There will be a dedicated multistage compressor to deliver compressed H<sub>2</sub> via a bunker hose to the ferry pressurised storage container. The terminal will provide the bunker hose and will have a dedicated area for storage and compressor. Before the bunker operation, the system and hose will be purged by terminal. Once ready for the bunker operation, the hose will be connected to the ship bunker manifold. There is one HP line for compressed H<sub>2</sub> bunkering. The system will be purged on both sides and upon measurement of O<sub>2</sub>, if acceptable, H<sub>2</sub> will be introduced and N<sub>2</sub> will be purged. N<sub>2</sub> will be measured, and once it is at an acceptable limit, the bunker operation will start. The ship will balance the pressure in all tanks and the terminal will start delivering bunker H<sub>2</sub> from stored HP tanks. Once reached a certain threshold, the compressor will start to boost pressure and fill the compressed H<sub>2</sub> tanks on ship. It is expected that the bunker operation will be completed in less than 6 hr.</p>	

No.: 18		Terminal Bunker delivery								
Item	Deviation	Causes	Consequences	Matrix	Severity	Likelihood	Risk	Safeguards	Recommendations	Comment
18.1	Hose	1. Hose Failure <b>Comment:</b> It is expected that large size hose is needed and they are not available. Improper bolt up market and need require NTQ	1. H <sub>2</sub> leakage at terminal	Asset	3	C	High	1. Proper inspection and maintenance 2. Before operation pressure/leak test 3. H <sub>2</sub> sensor 4. Fire detector 5. ESD 6. Ship to shore link 7. QC/DC coupling 8. Safety zone and exclusion zone established	106. Conduct Fire Hazards Analysis, Gas Dispersion Analysis, Explosion Analysis to establish hazardous area zones and hazardous impact. Provide appropriate mitigations for fire and explosion consequences. Evaluate if the vessel structural damage due to explosion can compromise the damage stability and integrity of the vessel. Evaluate the vent mast design and hazardous area zone established by the vent mast.  121. Bunker hose needs to go through New Technology qualification program as size and length need may not be available.	

No.: 18		Terminal Bunker delivery								
Item	Deviation	Causes	Consequences	Matrix	Severity	Likelihood	Risk	Safeguards	Recommendations	Comment
									122. Exclusion zone and safety zone are to be established by fire dispersion analysis with terminal and ship.	
			2. Fire	Asset	3	B	Moderate			
			3. Explosion	Overall	S4-Major	LB-Unlikely	High			
			4. Human injury	Injury	3	B	Moderate			
18.2	Compressor	1. Compressor delivering higher pressure	1. Damage to piping, hose equipment in system	Asset	3	B	Moderate	1. Pressure monitoring alarm and shutdown	123. Detail HAZOP to be performed for entire operation and appropriate safety to be in place.	
			2. H <sub>2</sub> leak, fire	Overall	S3-Moderate	LB-Unlikely	Moderate			
		2. Compressor seal leak	2. H <sub>2</sub> leak, fire	Overall	S3-Moderate	LB-Unlikely	Moderate		106. Conduct Fire Hazards Analysis, Gas Dispersion Analysis, Explosion Analysis to establish hazardous area zones and hazardous impact. Provide appropriate mitigations for fire and explosion consequences. Evaluate if the vessel structural damage due to explosion can compromise the damage stability and integrity of the vessel. Evaluate the vent mast design and hazardous area zone established by the vent mast.	

No.: 18		Terminal Bunker delivery								
Item	Deviation	Causes	Consequences	Matrix	Severity	Likelihood	Risk	Safeguards	Recommendations	Comment
									122. Exclusion zone and safety zone are to be established by fire dispersion analysis with terminal and ship. 123. Detail HAZOP to be performed for entire operation and appropriate safety to be in place. 124. Design need to consider proper pressure management and control considering delivering bunker to multiple module and cylinder.	
18.3	HP Storage PV	1. H <sub>2</sub> leak	1. Fire / explosion	Overall	S3-Moderate	LC-Possible	High	1. Design 2. Maintenance 3. Fire and Gas detector 4. Installation in open or properly ventilated area 5. ESD	122. Exclusion zone and safety zone are to be established by fire dispersion analysis with terminal and ship. 125. Proper selection of storage cylinder and piping to be further studied at detail design stage.	
18.4	Cooler Heat Exchanger	1. H <sub>2</sub> leak		Asset	2	c	Moderate	1. design 2. Inspection/maintenance 3. Fire and gas detector		

## Appendix X – List of Recommendations Product Carrier

No.	Action	References
1	Leak detection in semi enclosed design should further studied for the effectiveness of fixed hydrogen detectors	2.1 Hydrogen leakage – Bunker Station
2	Locating the bunker station more inwards	2.13 Ship movement/Marine environment – Bunker Station
3	Conduct Fire Hazards Analysis, Gas Dispersion Analysis, Explosion Analysis to establish hazardous area zones and hazardous impact. Provide appropriate mitigations for fire and explosion consequences. Evaluate if the vessel structural damage due to explosion can compromise the Cargo tank integrity. Evaluate the vent mast design and hazardous area zone established by the vent mast.	2.1 Hydrogen leakage – Bunker Station 10.1 Low pressure Vent system – Venting System & vents
4	Roof of the bunker station to slop outwards to avoid any possibility of gas accumulation	2.1 Hydrogen leakage – Bunker Station
5	Dropped objects studies to be performed considering H <sub>2</sub> equipment/piping in zone of lift and appropriate drop protection are to be provided	2.1 Hydrogen leakage – Bunker Station 2.2 Bunker hose failure – Bunker Station 4.1 TCS connection and manifolding of tanks on each module and between module to make as one tank – Hydrogen Tank Connections & System 5.1 General – Fuel Preparation System
6	Develop detail procedure for leak/ tightness test of bunker lines between tank stop valves/ ESD valved on ship and shore with appropriate fluid medium suitable for H <sub>2</sub> service and capable of replicating H <sub>2</sub> leak (hydrogen, helium, nitrogen- H <sub>2</sub> )	2.1 Hydrogen leakage – Bunker Station 2.2 Bunker hose failure – Bunker Station 2.9 Bunkering by Truck (TTS) - too many connections/disconnections – Bunker Station
7	Consider Proper selection of the valves to minimise the fugitive emissions and develop a plan to monitor the fugitive emissions	2.1 Hydrogen leakage – Bunker Station
8	For any semi enclosed or enclosed space where H <sub>2</sub> is present in equipment/piping consider providing gas detections and continuous ventilation even not in use	2.1 Hydrogen leakage – Bunker Station
9	Consider conducting proper vibration analysis and support to mitigate vibration be provided	2.1 Hydrogen leakage – Bunker Station 2.2 Bunker hose failure – Bunker Station 5.1 General – Fuel Preparation System
10	Procedures to be developed to monitor vibrations periodically	2.1 Hydrogen leakage – Bunker Station 2.2 Bunker hose failure – Bunker Station
11	At detailed design stage perform HAZOP and FMEA for piping systems and controls	2.1 Hydrogen leakage – Bunker Station 2.6 Backpressure from H <sub>2</sub> Storage tank – Bunker Station 2.7 Overpressurisation of bunker line – Bunker Station 5.1 General – Fuel Preparation System
12	Hoses need to follow technology verifications/New qualification program for proper certification	2.1 Hydrogen leakage – Bunker Station 2.2 Bunker hose failure – Bunker Station
13	Hose support procedures to be developed based on manufacturer recommendation and analysis	2.1 Hydrogen leakage – Bunker Station 2.2 Bunker hose failure – Bunker Station
14	Secondary retentions are to be provided for hose in case of failure to limit consequence of failure.	2.1 Hydrogen leakage – Bunker Station 2.2 Bunker hose failure – Bunker Station
15	Hose maintenance and leak testing are to be developed in consolidation with hose manufacturer	2.1 Hydrogen leakage – Bunker Station 2.2 Bunker hose failure – Bunker Station
16	Safety zone and restriction zone are to be developed for bunkering operation	2.1 Hydrogen leakage – Bunker Station 2.2 Bunker hose failure – Bunker Station 2.13 Ship movement/Marine environment – Bunker Station

No.	Action	References
17	Hose motion analysis to be performed during mooring analysis to understand hose movement for operational envelop and proper support and protection to be provided for hose	2.2 Bunker hose failure – Bunker Station
18	Proper hose handling procedure are to be developed for bunkering operation	2.2 Bunker hose failure – Bunker Station
19	Detail HAZOP to be conducted considering bunker provider system also.	2.7 Overpressurisation of bunker line – Bunker Station
20	Tank in service inspection and maintenance plan to be developed - as tank are consider inspectable and there is only one connection to tank for loading/unloading H <sub>2</sub>	3.1 Tanks – Hydrogen Storage System
21	Consider providing Blowdown system for CCPV modules in case of fire/leak/damage to module	3.1 Tanks – Hydrogen Storage System
22	Consider during design such that any connection failure leakage resulting in leakage will not impinging on tank surface	3.1 Tanks – Hydrogen Storage System
23	Tanks support are to be design per IGF coed marine load requirements	3.2 Tank Structural Interface – Hydrogen Storage System
24	Tank FMECA are to be performed considering all marine and operational loads	3.1 Tanks – Hydrogen Storage System 3.2 Tank Structural Interface – Hydrogen Storage System
25	Leak/Jet and fire detection are to be further studied	2.2 Bunker hose failure – Bunker Station
26	Any potential leak points are to be monitored or provided with deflector cover etc. to minimise leak consequence	2.2 Bunker hose failure – Bunker Station
27	Detail system design and risk analysis to be conducted with H <sub>2</sub> bunker supplier and bunker procedure HAZOP to be conducted	2.7 Overpressurisation of bunker line – Bunker Station
28	Vent mast are to consider during design full flow discharge from supply	2.7 Overpressurisation of bunker line – Bunker Station 10.2 High pressure – Venting System & vents
29	Hazardous areas around vent mast are to be specified per gas dispersion analysis (typically it is 15ft.) and applicable codes and standards	10.1 Low pressure Vent system – Venting System & vents 10.2 High pressure – Venting System & vents
30	Vent masts can ingress air and lead to back splash or detonation inside vent mast. Vent mast are to be designed to withstand such load to avoid damage Typically design for 200 psi	10.2 High pressure – Venting System & vents
31	Vent mast to design to avoid water ingress	10.2 High pressure – Venting System & vents
32	Vent mast piping are to be designed to avoid any high spot where H <sub>2</sub> can accumulate	10.2 High pressure – Venting System & vents
33	Vent mast are to be fully welded construction to avoid any leakage	10.2 High pressure – Venting System & vents
34	Vent mast to be checked for Bridge visibility and compliance to regulation	10.2 High pressure – Venting System & vents
35	Vent mast capacity are to be design based on maximum amount of H <sub>2</sub> that can be discharge in TPRD event due to fire near tank or jet fire impinging on tank	10.2 High pressure – Venting System & vents
36	Compatibility check is to be done between H <sub>2</sub> and cargo carried to avoid any issue	10.2 High pressure – Venting System & vents
37	Consider protecting vent lines in case of fire by providing water spray or other means in TPRD event	10.2 High pressure – Venting System & vents 12.1 New – Firefighting Systems
38	All LP vents are to be further studies for combining all in one vent or keep certain vent separate (e.g., crank case vent, GUV vents, fuel supply line from FPR))	10.1 Low pressure Vent system – Venting System & vents
39	Detail HAZOP of bunker procedure and system are to be conducted	2.8 Pressure mismatch – Bunker Station
40	Consider providing NRV on bunker line to prevent flow from tank to bunker manifold	2.8 Pressure mismatch – Bunker Station
41	Fuel management philosophies are to be developed per IGF code requirement and based on Fuel management philosophy system and bunker procedure are to be developed. e.g., parallel loading or series loading of fuel tanks Simultaneous/individual.	2.8 Pressure mismatch – Bunker Station

No.	Action	References
42	Bunkering operation risk assessment are to be done separately with port authority and bunker provider	2.9 Bunkering by Truck (TTS) - too many connections/disconnections – Bunker Station
43	Maintenance FMECA are to be done for H <sub>2</sub> system	2.10 Human error – Bunker Station 9.1 General – Ventilation System
44	Detailed maintenance and handling procedures are to be developed considering maintenance FMECA failure modes	2.10 Human error – Bunker Station
45	Proper operational procedure is to be developed and training plan to be developed	2.10 Human error – Bunker Station
46	SY/repair yard personnel are to be trained in safety requirement of H <sub>2</sub> and fabrication requirement per codes and standards.	2.10 Human error – Bunker Station
47	Consider for Ice class vessel all valves and manifolds in enclosed space provide TCS and FPS etc.	2.11 Low atmospheric temperature – Bunker Station
48	Vent mast ice preventions are to be further studied and appropriate mitigation are to be developed	2.11 Low atmospheric temperature – Bunker Station
49	All systems are to be designed to withstand ice load and cold temperature	2.11 Low atmospheric temperature – Bunker Station
50	Mooring analysis are to be done for each type of bunkering	2.13 Ship movement/Marine environment – Bunker Station
51	When bunker in side-by-side configuration vessel separation measurement to be consider as safety measure	2.13 Ship movement/Marine environment – Bunker Station
52	Detail bunker operation HAZID and risk assessment are to be conducted once detail design is available	2.14 Berthing and mooring – Bunker Station
53	Operational envelop are to consider tide as one element impacting safety	2.14 Berthing and mooring – Bunker Station
54	Further study is to be conducted for effectiveness of H <sub>2</sub> fire detector in ice condition/low temperature atmospheric condition	3.1 Tanks – Hydrogen Storage System
55	Consider manual blow down as backup to TPRD system	3.1 Tanks – Hydrogen Storage System
56	Effectiveness of TPRD system for tank protection are to be further studied considering ice formation on TPRD element, rain and low atmospheric condition	3.1 Tanks – Hydrogen Storage System
57	Cargo tank module (ISO frame) to be design and connection are to withstand all marine load specified in IGF code	3.1 Tanks – Hydrogen Storage System
58	Develop proper inspection plan for module connections	3.1 Tanks – Hydrogen Storage System
59	Tank support to ISO frame is to be designed for all marine load applicable	3.1 Tanks – Hydrogen Storage System
60	Tank modules need to meet IGF interim guideline tank location criteria and should be away from potential damage penetration zone	3.1 Tanks – Hydrogen Storage System
61	Dropped object study to be conducted and appropriate drop protection to be consider protecting tank, manifold and piping	3.1 Tanks – Hydrogen Storage System
62	Tank manifold to be design or protected against ice formation and loads	3.1 Tanks – Hydrogen Storage System
63	Tank material are to be selected for exposure to sea/salt water	3.1 Tanks – Hydrogen Storage System
64	Consider all piping manifold installed to avoid green water exposure	3.1 Tanks – Hydrogen Storage System
65	Cargo Tank opening are to be studied and if needed need to be moved for accessibility etc.	3.1 Tanks – Hydrogen Storage System
66	Electrical equipment located in H <sub>2</sub> Hazard are to be suitable for H <sub>2</sub>	3.1 Tanks – Hydrogen Storage System
67	Emergency procedure are to be developed to deinventory of H <sub>2</sub> in case of emergency e.g., engine room fire, cargo tank fire, accommodation fire etc.	3.1 Tanks – Hydrogen Storage System
68	Consider piping to meet leak before fail criteria	9.1 General – Ventilation System



No.	Action	References
69	Ventilation analysis and gas dispersion analysis are to be performed for air inlet/outlet location, gas detector mapping and optimal layout to avoid any possibility of H <sub>2</sub> accumulation inside space	4.1 TCS connection and manifolding of tanks on each module and between module to make as one tank – Hydrogen Tank Connections & System 9.1 General – Ventilation System
70	Material is to be selected for H <sub>2</sub> service and marine environment considering green water effect	6.1 double wall piping – Hydrogen Supply Piping
71	Valve and other equipment, seals etc. to be selected based on fugitive emission minimization	9.1 General – Ventilation System
72	System is to be designed to have blowdown capability to remove H <sub>2</sub> from system in case of total loss of ventilation	3.1 Tanks – Hydrogen Storage System 9.1 General – Ventilation System
73	Further study to be done considering pressure reduction at TCS space or at final pressure reduction station. Issue is to run HP H <sub>2</sub> piping on deck or only LP H <sub>2</sub> piping on deck except bunker line.	5.1 General – Fuel Preparation System
74	Piping stress analysis to be performed for all operational condition	5.1 General – Fuel Preparation System
75	Consider Testing of annulus space (outer pipe tightness) - with He or H <sub>2</sub> id annulus is continuously vented	6.1 double wall piping – Hydrogen Supply Piping
76	Further study to be conducted for Annulus pressurised vs continuously vented option	6.1 double wall piping – Hydrogen Supply Piping
77	Ventilation rate study to be conducted considering maximum leak rate	6.1 double wall piping – Hydrogen Supply Piping
78	Develop proper maintenance procedure for outer and inner pipe and testing	6.1 double wall piping – Hydrogen Supply Piping
79	Design criteria for enclosure are to be further studied considering H <sub>2</sub> leak inside enclosure	7.1 GVU – Engine
80	Enclosure ventilation rate are to be further study - consider IEC guideline/ NFPA	7.1 GVU – Engine
81	Consider providing H <sub>2</sub> detector for each GVU	7.1 GVU – Engine
82	Consider providing separate ventilation system for DG and Main Engine	7.1 GVU – Engine
83	Consider designing Engine room GVU to withstand internal deflagration /detonation and consider deflagration protection criteria	7.1 GVU – Engine
84	Engine manufacturer to further study H <sub>2</sub> detection in crank case(carter)	7.2 H <sub>2</sub> in crank case – Engine
85	Explosion relief discharge are to be further study in case unburnt H <sub>2</sub> comes out of explosion relief	7.2 H <sub>2</sub> in crank case – Engine
86	Engine component and its control system FMECA are to be performed	7.2 H <sub>2</sub> in crank case – Engine 7.4 H <sub>2</sub> flow to air intake – Engine 7.5 Unburned H <sub>2</sub> in Exhaust receiver and exhaust system – Engine
87	Expansion tank vent line to be routed to proper location	7.3 H <sub>2</sub> in cooling water – Engine
88	Consider providing H <sub>2</sub> detector on expansion tank or alternate means	7.3 H <sub>2</sub> in cooling water – Engine
89	Exhaust from Genset is to be separated from main engine exhaust	8.1 2 Hydrogen Powered – Genset
90	Issue needs to be further study for impact of any H <sub>2</sub> leak inside ER.	7.7 Cylinder cover lifting – Engine
91	Gassing up, degassing procedure are to be developed and appropriate instrument/ sampling point to be provided to verify operation	13.4 Dry docking – Other Operating Modes
92	Engine manufacturer to collect data on H <sub>2</sub> slip and other combustion product during type testing and provide data to owner and class society	13.1 Startup – Other Operating Modes 13.5 Heavy weather condition – Other Operating Modes
93	Capacity and N <sub>2</sub> requirement for all operational needs are to be studied and appropriate N <sub>2</sub> capacity are to be provided	13.4 Dry docking – Other Operating Modes
94	Detail gas dispersion, fire/explosion analysis, radian heat load are to be conducted considering various discharge rates and fire situation to vent mast (HP and LP) or local discharge	10.2 High pressure – Venting System & vents 14.1 Cargo Operations at port – Other vessel Operations
95	Detail emergency procedure are to be developed for fire and other emergency	14.1 Cargo Operations at port – Other vessel Operations

No.	Action	References
96	Emergency plan are to be developed with port authority	14.1 Cargo Operations at port – Other vessel Operations
97	Considering H <sub>2</sub> proximity for other ship and they are not design for H <sub>2</sub> exposure further study are to be conducted to identify risk and appropriate mitigation	14.2 Cargo lightening at sea – Other vessel Operations
98	Detail maintenance procedure and training re to be developed for ship H <sub>2</sub> system	15.1 New – Testing, Maintenance & Inspection
99	Further study is to be conducted for drop point and helicopter operation considering H <sub>2</sub> storage, TCS space and other H <sub>2</sub> equipment/piping	3.1 Tanks – Hydrogen Storage System
100	For all normal operation any emission/venting of H <sub>2</sub> are to be consider as GHG and to be accounted purging, degassing, gassing up, shutdown, normal blowdown etc.	13.1 Startup – Other Operating Modes
101	Qualified people availability for H <sub>2</sub> fabrication/welding etc. can be challenging and need to be consider in overall project risk	15.1 New – Testing, Maintenance & Inspection
102	Hydrogen material issue?	15.1 New – Testing, Maintenance & Inspection
103	H <sub>2</sub> has reverse JT and crew need to be aware of it	15.1 New – Testing, Maintenance & Inspection
104	Suitable H <sub>2</sub> detection method for marine use is to be developed	15.1 New – Testing, Maintenance & Inspection
105	Consider blowdown system upon detection of H <sub>2</sub>	2.1 Hydrogen leakage – Bunker Station
106	Safety and exclusion are to be developed	2.2 Bunker hose failure – Bunker Station 2.9 Bunkering by Truck (TTS) - too many connections/disconnections – Bunker Station
107	Proper training, detail procedure and testing to be developed considering H <sub>2</sub> application	2.1 Hydrogen leakage – Bunker Station 2.6 Backpressure from H <sub>2</sub> Storage tank – Bunker Station 2.7 Overpressurisation of bunker line – Bunker Station 2.8 Pressure mismatch – Bunker Station 2.9 Bunkering by Truck (TTS) - too many connections/disconnections – Bunker Station
108	Hose handling procedure are to be developed - deployment, support, retrieval, storage.	2.1 Hydrogen leakage – Bunker Station
109	Detail study for each equipment and system to be conducted for possibility of trapped hydrogen at design stage	2.5 Trapped hydrogen – Bunker Station
110	System design to consider max. pressure differential and design system to operate safely considering human capability	2.8 Pressure mismatch – Bunker Station
111	Fire and Gas detection to be further studied and appropriate detector /system to be selected to function in ice formation condition	2.11 Low atmospheric temperature – Bunker Station
112	Hose motion analysis to be performed considering transfer configuration to avoid any contact with hull or entanglement.	2.13 Ship movement/Marine environment – Bunker Station
113	Move bunker station inward to avoid wave impact and green water impact	1.1 Weather impact during voyage – Vessel General Arrangement
114	Study green water and wave impact on H <sub>2</sub> tank, manifold and piping.	1.1 Weather impact during voyage – Vessel General Arrangement
115	bunk	2.14 Berthing and mooring – Bunker Station
116	If bunkering done at night lighting requirement study to be conducted	2.13 Ship movement/Marine environment – Bunker Station
117	Tank material to be tested for saltwater exposure	3.1 Tanks – Hydrogen Storage System
118	Consider enclosed Tank connection space with ventilation etc. to protect against ice, green water, wave etc.	4.1 TCS connection and manifolding of tanks on each module and between module to make as one tank – Hydrogen Tank Connections & System
119	Material selection to resist marine environment, sea water	4.1 TCS connection and manifolding of tanks on each module and between module to make as one tank – Hydrogen Tank Connections & System

No.	Action	References
120	Due to wide flammability and low ignition energy requirements, risk of deflagration /detonation exists if air ingress occur inside vent lines. Further studies are to be conducted to avoid such potential. (e.g., N <sub>2</sub> continuous purge, design pipe to withstand deflagration /detonation pressure	5.2 Double wall piping – Fuel Preparation System 10.1 Low pressure Vent system – Venting System & vents
121	Consider designing piping to leak before failure criteria	5.2 Double wall piping – Fuel Preparation System
122	Due to wide flammability range and low ignition energy possibility of deflagration /detonation exist, further study is required if air venting is proposed for annulus to minimise such potential design outer/inner pipe to withstand deflagration /detonation	6.1 Double wall piping – Hydrogen Supply Piping 10.1 Low pressure Vent system – Venting System & vents
123	Vents from GUV consider Hazardous and need further study for location where to vent	7.1 GUV – Engine
124	Engine exhaust to be further evaluated for explosion potential	7.5 Unburned H <sub>2</sub> in Exhaust receiver and exhaust system – Engine
125	Further study to be conducted for any possibility of H <sub>2</sub> in ER due to engine issue and consideration to be providing H <sub>2</sub> detector and appropriate measure to reduce risk	7.7 Cylinder cover lifting – Engine
126	Gen set compartment H <sub>2</sub> safety to be designed similar to ER	8.1 2 Hydrogen Powered – Genset
127	Ventilation system to be reevaluated once more information is available	9.1 General – Ventilation System
128	High pressure high flow vents are to be separated from low pressure low flow vent system to avoid any back pressure issue. Vent and relief capacity study to be conducted	10.1 Low pressure Vent system – Venting System & vents
129	Consider providing H <sub>2</sub> detector on all vent lines	10.1 Low pressure Vent system – Venting System & vents
130	Further study to be performed in cargo vent content enter in H <sub>2</sub> vent lines	10.2 High pressure – Venting System & vents
131	Local small jet fire can exist from very small leak. Proper study to be performed to detect such fire. Proper PPE and training to be developed	9.1 General – Ventilation System

## Appendix XI – HAZID Register Product Carrier

1	Vessel General Arrangement
<p>GENERAL ARRANGEMENT</p> <p>Product tanker. The general arrangement was presented. Discussion about hydrogen need. For 14 days 45 tons of hydrogen required.                  Steel vs composite pressure vessel discussion:                  Large H<sub>2</sub> tank at 350 bar do not exist and very heavy. So, it is not feasible to use large multiple steel tanks. Smaller H<sub>2</sub> steel tanks are available but again will be heavy and too many tanks with lots of connection. Option was not considered                  . Replacement of the engines. Each engine is supplied by the GVU. The storage is 200 bar. New construction.</p> <p>H<sub>2</sub> storage in CCPV containerise module by Hexagon Lincoln. Already approved for road transportation. 250 bar storage. Design temperature -40 oF to 60 oF                  Proposal is to install CCPV container module on weather deck fwd. and aft of cargo manifold. Total 24 module.</p> <p>CCPV is protect by TPRD to protect against fire and/radiant heat/high temperature due to sensitivity of CCPV to heat                  Bunker manifold will be protected by pressure relief valve to protect against over pressure during bunkering</p> <p>Vent mast for hydrogen is located with vent mast for cargo near cargo manifold at top of cargo vent house</p> <p>Bunker manifold is located between cargo manifold and fwd. CCPV module on port and starboard side</p> <p>Bunker manifold is semi enclosed during bunkering operation and will be closed during voyage to protect against weather, wind, green water etc. There is only one bunker line</p> <p>Each ISO module tank (four) is connected to form one tank. Each tank supply will be run along pipe tunnel side in open and connect in one manifold at fuel processing module. Fuel Processing module will reduce H<sub>2</sub> pressure from 250 bar max to 10 bar supply pressure to GVU in multi stage reduction. At fuel processing supply will be for each GVU separately. Piping from FPS to GVU is double wall.                  Multiple ISO module will be connected to form one tank. Total four fuel tanks. (8 + 8 + 4 + 4)</p> <p>GVU is design to take 10 bar H<sub>2</sub> supply and reduce pressure for consumer between 4 to 6 bar depending on demand. Each consumer has its own GVU. GVU is purged explosion proof unit, in compliance with gas safe machinery space requirement                  Piping form GVU to engine and all piping on engine is double wall minimizing possibility of H<sub>2</sub> leakage inside engine room.                  FPS is proposed at fwd. of accommodation on starboard side</p> <p>Main engine require diesel pilot fuel around 20%.</p> <p>Purging will be done by N<sub>2</sub>. Existing N<sub>2</sub> will be reevaluated for proper capacity requirement</p>	

No.: 1		Vessel General Arrangement								
Item	Deviation	Causes	Consequences	Matrix	Severity	Likelihood	Risk	Safeguards	Recommendations	Comment
1.1	Weather impact during voyage	1. High Wave	1. Damage to bunker station	Asset	3	C	High		113. Move bunker station inward to avoid wave impact and green water impact	
		2. Wave impact on H <sub>2</sub> Tank and manifold (linked from 3.1)								
		3. Green water impact on H <sub>2</sub> Tank and manifold	3. Damage to piping	Overall	S4-Major	LC-Possible	Extreme		114. Study green water and wave impact on H <sub>2</sub> tank, manifold, and piping.	

2	Bunker Station
<p>Bunker Station on port and starboard. Enclosed bunker station appropriate ventilation and gas detection will be provided.</p> <p>Bunker station is semi enclosed while bunkering as outboard door will open. During voyage will be enclosed to protect against weather, green water etc..</p> <p>Only one bunker line to load compressed H<sub>2</sub></p> <p>Located between cargo manifold and fwd. CCPV H<sub>2</sub> module on port and starboard side</p> <p>Bunker manifold will provided with pressure relief valve to protect against over pressure</p> <p>Bunker hose will be supplied by terminal or bunker barge</p> <p>After bunkering bunker lines will be depressurised and purged</p> <p>Bunker line will be isolated at tank connection by double-block and bleed</p> <p>Product carrier will provide support for handling, installation and removal of bunker hose</p>	

No.: 2		Bunker Station								
Item	Deviation	Causes	Consequences	Matrix	Severity	Likelihood	Risk	Safeguards	Recommendations	Comment
2.1	Hydrogen leakage	1. Material failure/degradation/corrosion from marine environment/H <sub>2</sub> embrittlement	1. Hydrogen in bunker area	Asset	2	D	High	1. Hydrogen detector 2. Fire detector 3. Pressure and temperature monitoring from crew 4. Proper Procedures and Trainings (as per IGF code) 5. Ship to shore connection for ESD function 6. ESD 7. QC/DC coupling 8. Purging system	1. Leak detection in semi enclosed design should further studied for the effectiveness of fixed hydrogen detectors	

No.: 2		Bunker Station								
Item	Deviation	Causes	Consequences	Matrix	Severity	Likelihood	Risk	Safeguards	Recommendations	Comment
								9. Certified electrical equipment for hydrogen 10. Distance from bunker station to cargo manifold (currently 3 m) - move it more towards center line 11. Bunker station is enclosed from 3 side 12. Ventilation in bunker area 16. Leak test (tightness test before intro of hydrogen) (5% hydrogen and 95% nitrogen or Helium) 19. Electrical groundings/grounding reel provided between ship and terminal/bunker vessel 20. Crew continuously monitoring the bunkering operation and deck piping from a safe area 21. Bunkering in continuously manned operation	3. Conduct Fire Hazards Analysis, Gas Dispersion Analysis, Explosion Analysis to establish hazardous area zones and hazardous impact. Provide appropriate mitigations for fire and explosion consequences. Evaluate if the vessel structural damage due to explosion can compromise the Cargo tank integrity. Evaluate the vent mast design and hazardous area zone established by the vent mast. 4. Roof of the bunker station to slop outwards to avoid any possibility of gas accumulation 6. Develop detail procedure for leak/tightness test of bunker lines between tank stop valves/ESD valved on ship and shore with appropriate fluid medium suitable for H <sub>2</sub> service and capable of replicating H <sub>2</sub> leak (hydrogen, helium, nitrogen-H <sub>2</sub> ) 16. Safety zone and restriction zone are to be developed for bunkering operation	

No.: 2		Bunker Station								
Item	Deviation	Causes	Consequences	Matrix	Severity	Likelihood	Risk	Safeguards	Recommendations	Comment
							High		105. Consider blowdown system upon detection of H <sub>2</sub>	
			2. Fire & Explosion	Asset	3	C	High			
			3. Human injury to ship personnel or port personnel	Injury	3	B	Moderate			
			7. Impact of surrounding area and cargo vent room	Asset	3	C	High			
			8. Hydrogen accumulation in the top of enclosed space	Overall	S3-Moderate	LC-Possible	High			
			9. Fire & Explosion which can lead to structural damage of bunker station/piping/hose	Overall	S4-Major	LB-Unlikely	High			
			10. Loss of fuel	Asset	2	B	Low			
		2. Dropped object	5. Damage to hose or piping	Asset	3	C	High	1. Hydrogen detector 15. No lifting allowed during bunkering	5. Dropped objects studies to be performed considering H <sub>2</sub> equipment/piping in zone of lift and appropriate drop protection are to be provided 16. Safety zone and restriction zone are to be developed for bunkering operation	
			6. Pipe/hose rupture	Overall	S4-Major	LC-Possible	Extreme			



No.: 2		Bunker Station								
Item	Deviation	Causes	Consequences	Matrix	Severity	Likelihood	Risk	Safeguards	Recommendations	Comment
			9. Fire & Explosion which can lead to structural damage of bunker station/piping/hose	Overall	S4-Major	LB-Unlikely	High			
		3. Improper connection (QC/DC coupling or spool)	1. Hydrogen in bunker area	Asset	2	D	High	16. Leak test (tightness test before intro of hydrogen) (5% hydrogen and 95% nitrogen or Helium) 17. Proper training for connections (makeup /breakup/ testing)	6. Develop detail procedure for leak/ tightness test of bunker lines between tank stop valves/ ESD valved on ship and shore with appropriate fluid medium suitable for H <sub>2</sub> service and capable of replicating H <sub>2</sub> leak (hydrogen, helium, nitrogen-H <sub>2</sub> ) 107. Proper training, detail procedure and testing to be developed considering H <sub>2</sub> application	
			2. Fire & Explosion	Asset	3	C	High			
			3. Human injury to ship personnel or port personnel	Injury	3	B	Moderate			
			4. Hydrogen leak or disengagement/ Connection failure	Overall	S3-Moderate	LC-Possible	High			
			8. Hydrogen accumulation in the top of enclosed space	Overall	S3-Moderate	LC-Possible	High			
			9. Fire & Explosion which can lead to structural damage of bunker station/piping/hose	Overall	S4-Major	LB-Unlikely	High			

No.: 2		Bunker Station								
Item	Deviation	Causes	Consequences	Matrix	Severity	Likelihood	Risk	Safeguards	Recommendations	Comment
			10. Loss of fuel	Asset	2	B	Low			
			12. GHG emission	Environmental	2	C	Moderate			
		4. Fugitive emission <b>Comment:</b> Semi enclosed open design of bunker station	10. Loss of fuel	Asset	2	B	Low		7. Consider Proper selection of the valves to minimise the fugitive emissions and develop a plan to monitor the fugitive emissions  8. For any semi enclosed or enclosed space where H <sub>2</sub> is present in equipment/piping consider providing gas detections and continuous ventilation even not in use	
			11. Hydrogen leak external from any connection, equipment, valve stem etc.	Asset	2	C	Moderate			
			12. GHG emission	Environmental	2	C	Moderate			
		5. Fatigue & Vibration leading to cracks	1. Hydrogen in bunker area	Asset	2	D	High	1. Hydrogen detector 2. Fire detector 3. Pressure and temperature monitoring from crew 5. Ship to shore connection for ESD function 6. ESD 7. QC/DC coupling	9. Consider conducting proper vibration analysis and support to mitigate vibration be provided 10. Procedures to be developed to monitor vibrations periodically	

No.: 2		Bunker Station								
Item	Deviation	Causes	Consequences	Matrix	Severity	Likelihood	Risk	Safeguards	Recommendations	Comment
								12. Ventilation in bunker area 19. Electrical groundings/grounding reel provided between ship and terminal/bunker vessel 20. Crew continuously monitoring the bunkering operation and deck piping from a safe area 21. Bunkering in continuously manned operation		
			2. Fire & Explosion	Asset	3	C	High			
			3. Human injury to ship personnel or port personnel	Injury	3	B	Moderate			
			6. Pipe/hose rupture	Overall	S4-Major	LC-Possible	Extreme			
			8. Hydrogen accumulation in the top of enclosed space	Overall	S3-Moderate	LC-Possible	High			
			11. Hydrogen leak external from any connection, equipment, valve stem etc.	Asset	2	C	Moderate			
			12. GHG emission	Environmental	2	C	Moderate			
		6. Human Error <b>Comment:</b> Wrong valve opening	1. Hydrogen in bunker area	Asset	2	D	High	17. Proper training for connections (makeup /breakup/ testing)	107. Proper training, detail procedure and testing to be developed considering H <sub>2</sub> application	

No.: 2		Bunker Station								
Item	Deviation	Causes	Consequences	Matrix	Severity	Likelihood	Risk	Safeguards	Recommendations	Comment
			2. Fire & Explosion	Asset	3	C	High			
			4. Hydrogen leak or disengagement/ Connection failure	Overall	S3-Moderate	LC-Possible	High			
			14. Opening of a valve leading to leakage of hydrogen	Overall	S3-Moderate	LC-Possible	High			
		7. Vessel movement (linked from 2.13) <b>Comment:</b> see 2.13								
		8. Hose (linked from 2.2) <b>Comment:</b> No vapour return line only the supply line/ hose will be supplied by bunkering barge	2. Fire & Explosion	Asset	3	C	High		12. Hoses need to follow technology verifications/New qualification program for proper certification 13. Hose support procedures to be developed based on manufacturer recommendation and analysis 14. Secondary retentions are to be provided for those in case of failure to limit the consequence of failure. 15. Hose maintenance and leak testing are to be developed in consolidation with hose manufacturer 108. Hose handling procedure are to be developed - deployment, support, retrieval, storage.	

No.: 2		Bunker Station								
Item	Deviation	Causes	Consequences	Matrix	Severity	Likelihood	Risk	Safeguards	Recommendations	Comment
			15. Crack inside the hose leading to the gas release and trapped gas	Overall	S3-Moderate	LC-Possible	High			
			16. Damage to the hose during the handling and deployment of connections/disconnections	Asset	3	C	High			
		9. Pulsation from compression during bunkering	13. Vibration and pipping failure	Asset	3	C	High	18. Properly sized pulsation dampened	9. Consider conducting proper vibration analysis and support to mitigate vibration be provided	
		10. Signal failure or failure on the remote control, lack of notification, malfunction of the valve's instruments							11. At detailed design stage perform HAZOP and FMEA for piping systems and controls	
2.2	Bunker hose failure	1. Fatigue	1. Gas entrapment inside hose wall due to leakage from inner wall	Asset	2	D	High	1. ESD 2. Ship to shore link for ESD 3. P-T monitoring 4. Fire detector 5. Hose inspection/SOP before deployment of hose 6. Dual fuel engine	6. Develop detail procedure for leak/tightness test of bunker lines between tank stop valves/ ESD valved on ship and shore with appropriate fluid medium suitable for H <sub>2</sub> service and capable of replicating H <sub>2</sub> leak (hydrogen, helium, nitrogen-H <sub>2</sub> ) 12. Hoses need to follow technology verifications/New qualification program for proper certification	

No.: 2		Bunker Station								
Item	Deviation	Causes	Consequences	Matrix	Severity	Likelihood	Risk	Safeguards	Recommendations	Comment
									13. Hose support procedures to be developed based on manufacturer recommendation and analysis 14. Secondary retentions are to be provided for hose in case of failure to limit the consequence of failure. 15. Hose maintenance and leak testing are to be developed in consolidation with hose manufacturer 17. Hose motion analysis to be performed during mooring analysis to understand hose movement for operational envelop and proper support and protection to be provided for hose 25. Leak/Jet and fire detection are to be further studied 26. Any potential leak points are to be monitored or provided with deflector cover etc. to minimise leak consequence 106. Safety and exclusion are to be developed	

No.: 2		Bunker Station								
Item	Deviation	Causes	Consequences	Matrix	Severity	Likelihood	Risk	Safeguards	Recommendations	Comment
			2. H <sub>2</sub> leakage	Overall	S3-Moderate	LC-Possible	High			
			3. Fire and Explosion	Overall	S4-Major	LB-Unlikely	High			
			4. Risk to port personnel	Injury	2	C	Moderate			
			5. Unable to bunker	Asset	2	C	Moderate			
		2. Damage due to handling	1. Gas entrapment inside hose wall due to leakage from inner wall	Asset	2	D	High	2. Ship to shore link for ESD 3. P-T monitoring 4. Fire detector 5. Hose inspection/SOP before deployment of hose	5. Dropped objects studies to be performed considering H <sub>2</sub> equipment/piping in zone of lift and appropriate drop protection are to be provided  13. Hose support procedures to be developed based on manufacturer recommendation and analysis  14. Secondary retentions are to be provided for hose in case of failure to limit the consequence of failure.  15. Hose maintenance and leak testing are to be developed in consolidation with hose manufacturer  16. Safety zone and restriction zone are to be developed for bunkering operation	

No.: 2		Bunker Station								
Item	Deviation	Causes	Consequences	Matrix	Severity	Likelihood	Risk	Safeguards	Recommendations	Comment
							High		18. Proper hose handling procedure are to be developed for bunkering operation 25. Leak/Jet and fire detection are to be further studied	
			2. H <sub>2</sub> leakage	Overall	S3-Moderate	LC-Possible	High			
			3. Fire and Explosion	Overall	S4-Major	LB-Unlikely	High			
			4. Risk to port personnel	Injury	2	C	Moderate			
			5. Unable to bunker	Asset	2	C	Moderate			
		3. Hose movement, chaffing etc.	1. Gas entrapment inside hose wall due to leakage from inner wall	Asset	2	D	High		6. Develop detail procedure for leak/tightness test of bunker lines between tank stop valves/ESD valved on ship and shore with appropriate fluid medium suitable for H <sub>2</sub> service and capable of replicating H <sub>2</sub> leak (hydrogen, helium, nitrogen-H <sub>2</sub> ) 17. Hose motion analysis to be performed during mooring analysis to understand hose movement for operational envelop and proper support and protection to be provided for hose	



No.: 2		Bunker Station								
Item	Deviation	Causes	Consequences	Matrix	Severity	Likelihood	Risk	Safeguards	Recommendations	Comment
			2. H <sub>2</sub> leakage	Overall	S3-Moderate	LC-Possible	High			
			3. Fire and Explosion	Overall	S4-Major	LB-Unlikely	High			
			4. Risk to port personnel	Injury	2	C	Moderate			
			5. Unable to bunker	Asset	2	C	Moderate			
		4. Manufacturing defect	1. Gas entrapment inside hose wall due to leakage from inner wall	Asset	2	D	High		6. Develop detail procedure for leak/tightness test of bunker lines between tank stop valves/ESD valved on ship and shore with appropriate fluid medium suitable for H <sub>2</sub> service and capable of replicating H <sub>2</sub> leak (hydrogen, helium, nitrogen-H <sub>2</sub> ) 12. Hoses need to follow technology verifications/New qualification program for proper certification 17. Hose motion analysis to be performed during mooring analysis to understand hose movement for operational envelop and proper support and protection to be provided for hose	
			2. H <sub>2</sub> leakage	Overall	S3-Moderate	LC-Possible	High			

No.: 2		Bunker Station								
Item	Deviation	Causes	Consequences	Matrix	Severity	Likelihood	Risk	Safeguards	Recommendations	Comment
			3. Fire and Explosion	Overall	S4-Major	LB-Unlikely	High			
			4. Risk to port personnel	Injury	2	C	Moderate			
			5. Unable to bunker	Asset	2	C	Moderate			
		5. Over pressurisation of bunker line (linked from 2.7)								
		6. Vibration	1. Gas entrapment inside hose wall due to leakage from inner wall	Asset	2	D	High	1. ESD 4. Fire detector 5. Hose inspection/SOP before deployment of hose	9. Consider conducting proper vibration analysis and support to mitigate vibration be provided 10. Procedures to be developed to monitor vibrations periodically	
			2. H <sub>2</sub> leakage	Overall	S3-Moderate	LC-Possible	High			
			3. Fire and Explosion	Overall	S4-Major	LB-Unlikely	High			
			4. Risk to port personnel	Injury	2	C	Moderate			
			5. Unable to bunker	Asset	2	C	Moderate			
			6. Hydrogen leakage (linked to 2.1)							
2.3	Connection failure	1. See 2.1 for connection failure (linked from 2.1)								
2.4	Connection leakage	1. Hydrogen leakage (linked from 2.1)								

No.: 2		Bunker Station								
Item	Deviation	Causes	Consequences	Matrix	Severity	Likelihood	Risk	Safeguards	Recommendations	Comment
2.5	Trapped hydrogen	1. Trapped hydrogen due to design fault <b>Comment:</b> H <sub>2</sub> can be trapped due to design fault, such as space within equipment exposed to H <sub>2</sub> or next to H <sub>2</sub> exposure area etc.	1. Human exposure to HP H <sub>2</sub> during maintenance/operation	Injury	4	C	Extreme	1. Proper design 2. Proper procedure for purging before breaking connection or doing maintenance 3. Depressurisation	109. Detail study for each equipment and system to be conducted for possibility of trapped hydrogen at design stage	
			2. H <sub>2</sub> leakage	Asset	2	C	Moderate			
2.6	Backpressure from H <sub>2</sub> Storage tank	1. Leakage at tank valve(internal) - bunker line	1. H <sub>2</sub> in bunker line and hose after purging	Asset	3	C	High	1. Proper purging procedure 2. ESD valve closed after purging 3. Tank isolation is double block and bleed 4. Pressure monitoring 5. Portable gas detector with personnel working in area 6. PPE	11. At detailed design stage perform HAZOP and FMEA for piping systems and controls 107. Proper training, detail procedure and testing to be developed considering H <sub>2</sub> application	
			2. Human injury due to disconnecting under pressure	Injury	3	B	Moderate			
			3. H <sub>2</sub> discharge to atmosphere	Overall	S2-Minor	LC-Possible	Moderate			
			4. Human exposure to H <sub>2</sub>	Injury	3	C	High			
		2. ESD valve at bunker manifold open	3. H <sub>2</sub> discharge to atmosphere	Overall	S2-Minor	LC-Possible	Moderate	3. Tank isolation is double block and bleed	11. At detailed design stage perform HAZOP and FMEA for piping systems and controls	

No.: 2		Bunker Station								
Item	Deviation	Causes	Consequences	Matrix	Severity	Likelihood	Risk	Safeguards	Recommendations	Comment
								5. Portable gas detector with personnel working in area 6. PPE	107. Proper training, detail procedure and testing to be developed considering H <sub>2</sub> application	
			4. Human exposure to H <sub>2</sub>	Injury	3	C	High			
		3. Pressure surge due to pressure differential (linked from 2.8)								
2.7	Over pressurisation of bunker line	1. Supply pressure (high)	1. Piping Damage	Asset	3	C	High	1. Relief valve on bunker line vented to vent mast 2. Pressure monitoring, alarm and shutdown 3. Control station is manned and monitor Pressure-Temperature 4. ESD 5. Ship to shore link 6. Deck watch and monitoring	11. At detailed design stage perform HAZOP and FMEA for piping systems and controls 19. Detail HAZOP to be conducted considering bunker provider system also. 27. Detail system design and risk analysis to be conducted with H <sub>2</sub> bunker supplier and also bunker procedure HAZOP to be conducted 28. Vent mast are to consider during design full flow discharge from supply	
			2. Release of H <sub>2</sub>	Overall	S3-Moderate	LB-Unlikely	Moderate			
			3. Tank damage	Asset	3	B	Moderate			

No.: 2		Bunker Station								
Item	Deviation	Causes	Consequences	Matrix	Severity	Likelihood	Risk	Safeguards	Recommendations	Comment
			4. Damage of control valve on engine supply side	Overall	S2-Minor	LC-Possible	Moderate			
			5. Equipment damage (control valve, filter etc.)	Overall	S2-Minor	LB-Unlikely	Low			
			6. Fire and explosion	Overall	S3-Moderate	LC-Possible	High			
			7. Hose failure (linked to 2.2)	Overall	S3-Moderate	LC-Possible	High			
		2. Blocked flow	1. Piping Damage	Asset	3	C	High	1. Relief valve on bunker line vented to vent mast 2. Pressure monitoring, alarm and shutdown 3. Control station is manned and monitor Pressure-Temperature 4. ESD 5. Ship to shore link 6. Deck watch and monitoring	107. Proper training, detail procedure and testing to be developed considering H <sub>2</sub> application	
			2. Release of H <sub>2</sub>	Overall	S3-Moderate	LB-Unlikely	Moderate			
			5. Equipment damage (control valve, filter etc.)	Overall	S2-Minor	LB-Unlikely	Low			
			6. Fire and explosion	Overall	S3-Moderate	LC-Possible	High			

No.: 2		Bunker Station								
Item	Deviation	Causes	Consequences	Matrix	Severity	Likelihood	Risk	Safeguards	Recommendations	Comment
			7. Hose failure (linked to 2.2)	Overall	S3-Moderate	LC-Possible	High			
2.8	Pressure mismatch	1. Backflow of H <sub>2</sub> to Bunker provider	1. Pressure surge on LP side	Asset	3	C	High	1. System is to be designed to handle Pressure mismatch	39. Detail HAZOP of bunker procedure and system are to be conducted 40. Consider providing NRV on bunker line to prevent flow from tank to bunker manifold 41. Fuel management philosophy is to be developed per IGF code requirement and based on Fuel management philosophy system and bunker procedure are to be developed. e.g. parallel loading or series loading of fuel tanks Simultaneous/individual.	
			2. Sudden pressure rise in tank with LP	Asset	2	C	Moderate			
			3. Backpressure from H <sub>2</sub> Storage tank (linked to 2.6)							
		2. Mismatch in H <sub>2</sub> tank pressure	1. Pressure surge on LP side	Asset	3	C	High	1. System is to be designed to handle Pressure mismatch	39. Detail HAZOP of bunker procedure and system are to be conducted	

No.: 2		Bunker Station								
Item	Deviation	Causes	Consequences	Matrix	Severity	Likelihood	Risk	Safeguards	Recommendations	Comment
									40. Consider providing NRV on bunker line to prevent flow from tank to bunker manifold  41. Fuel management philosophy is to be developed per IGF code requirement and based on Fuel management philosophy system and bunker procedure are to be developed. e.g. parallel loading or series loading of fuel tanks Simultaneous/individual.  107. Proper training, detail procedure and testing to be developed considering H <sub>2</sub> application	
			2. Sudden pressure rise in tank with LP	Asset	2	C	Moderate			
		3. Human Error	1. Pressure surge on LP side	Asset	3	C	High		110. System design to consider max. pressure differential and design system to operate safely considering human capability	
			2. Sudden pressure rise in tank with LP	Asset	2	C	Moderate			

No.: 2		Bunker Station								
Item	Deviation	Causes	Consequences	Matrix	Severity	Likelihood	Risk	Safeguards	Recommendations	Comment
2.9	Bunkering by Truck (TTS) - too many connections/disconnections	1. connection leakage	1. H <sub>2</sub> leakage, fire and explosion	Overall	S3-Moderate	LC-Possible	High		6. Develop detail procedure for leak/tightness test of bunker lines between tank stop valves/ESD valved on ship and shore with appropriate fluid medium suitable for H <sub>2</sub> service and capable of replicating H <sub>2</sub> leak (hydrogen, helium, nitrogen-H <sub>2</sub> ) 42. Bunkering operation risk assessment are to be done separately with port authority and bunker provider 106. Safety and exclusion are to be developed 107. Proper training, detail procedure and testing to be developed considering H <sub>2</sub> application	1 out of 10 ports bunkering will be by truck. Approvals issues from port. Special sites for bunkering. Not all sites are safe for hydrogen
			2. Human injury	Injury	3	C	High			
		2. Human error - improper connection, no detail procedure etc.	1. H <sub>2</sub> leakage, fire and explosion	Overall	S3-Moderate	LC-Possible	High		42. Bunkering operation risk assessment are to be done separately with port authority and bunker provider 106. Safety and exclusion are to be developed	



No.: 2		Bunker Station								
Item	Deviation	Causes	Consequences	Matrix	Severity	Likelihood	Risk	Safeguards	Recommendations	Comment
									107. Proper training, detail procedure and testing to be developed considering H <sub>2</sub> application	
			2. Human injury	Injury	3	C	High			
2.10	Human error	1. Maintenance error	1. Hydrogen leakage	Injury	3	C	High	1. Training 2. Procedure	43. Maintenance FMECA are to be done for H <sub>2</sub> system 44. Detailed maintenance and handling procedures are to be developed considering maintenance FMECA failure modes 45. Proper operational procedure are to be developed and training plan to be developed 46. SY/repair yard personnel are to be trained in safety requirement of H <sub>2</sub> and fabrication requirement per codes and standards.	
			2. Fire / explosion	Overall	S3-Moderate	LB-Unlikely	Moderate			
		2. Improper operation	1. Hydrogen leakage	Injury	3	C	High	1. Training 2. Procedure	45. Proper operational procedure are to be developed and training plan to be developed	

No.: 2		Bunker Station								
Item	Deviation	Causes	Consequences	Matrix	Severity	Likelihood	Risk	Safeguards	Recommendations	Comment
			3. Block flow/over pressurisation	Asset	2	B	Low			
2.11	Low atmospheric temperature	1. Ice formation <b>Comment:</b> Route is in area where in winter ice forming will occurs due to low temperature	1. Make valve inoperable	Overall	S3-Moderate	LC-Possible	High	2. Ice class vessel	47. Consider for Ice class vessel all valves and manifolds in enclosed space provide TCS and FPS etc. 49. All system are to be designed to withstand ice load and cold temperature 111. Fire and Gas detection to be further studied and appropriate detector /system to be selected to function in ice formation condition	
			2. Connection can be breaking	Overall	S3-Moderate	LC-Possible	High			
			3. Ice load can lead to higher stress on piping instrument connection	Overall	S2-Minor	LC-Possible	Moderate			
			4. Limited accessibility	Overall	S2-Minor	LC-Possible	Moderate			
			5. Gas/fire detector may be inoperable	Asset	3	D	High			
		2. Vent mast can be blocked with Ice	6. When needed unable to discharge H <sub>2</sub>	Asset	3	C	High		48. Vent mast ice preventions are to be further studied and appropriate mitigation are to be developed	

No.: 2		Bunker Station								
Item	Deviation	Causes	Consequences	Matrix	Severity	Likelihood	Risk	Safeguards	Recommendations	Comment
			7. Over pressurisation of system leads to system/component failure	Overall	S4-Major	LB-Unlikely	High			
		3. Equipment failure due to material failure	8. H <sub>2</sub> release	Overall	S3-Moderate	LC-Possible	High	1. Proper selection of material and impact tested material for low temperature application	49. All system are to be designed to withstand ice load and cold temperature	
2.12	Ice formations	1. Low atmospheric temperature (linked from 2.11)								
2.13	Ship movement/Marine environment	1. High wind <b>Comment:</b> Fender will be provided by bunker facility	1. Hydrogen leakage (linked to 2.1)					1. QC/DC coupling 2. ERS system 3. ESD 4. ship to shore/ship link 5. Mooring line load monitoring 6. Restriction on weather envelop 7. Weather monitoring 10. Operational enveloped are define and monitored	50. Mooring analysis are to be done for each type of bunkering 51. When bunker in side-by-side configuration vessel separation measurement to be consider as safety measure	
			2. Higher load on hose connection	Asset	3	B	Moderate			
			4. Bunker manifold failure due to higher loads	Asset	3	B	Moderate			
			5. Higher load on fender	Asset	2	B	Low			
			6. Higher load on mooring lines and mooring line failure	Asset	2	B	Low			

No.: 2		Bunker Station								
Item	Deviation	Causes	Consequences	Matrix	Severity	Likelihood	Risk	Safeguards	Recommendations	Comment
			7. Higher ship motion/movement	Asset	3	C	High			
		2. Hi waves due to passing vessel	1. Hydrogen leakage (linked to 2.1)					1. QC/DC coupling 2. ERS system 3. ESD 4. ship to shore/ship link 5. Mooring line load monitoring 6. Restriction on weather envelop 7. Weather monitoring 8. No bunkering during lightening or thunderstorm 9. Inspection of mooring line 10. Operational enveloped are define and monitored	16. Safety zone and restriction zone are to be developed for bunkering operation 50. Mooring analysis are to be done for each type of bunkering 51. When bunker in side by side configuration vessel separation measurement to be consider as safety measure	
			2. Higher load on hose connection	Asset	3	B	Moderate			
			3. Damage to hose	Overall	S3-Moderate	LC-Possible	High			
			4. Bunker manifold failure due to higher loads	Asset	3	B	Moderate			
			5. Higher load on fender	Asset	2	B	Low			
			6. Higher load on mooring lines and mooring line failure	Asset	2	B	Low			
			7. Higher ship motion/movement	Asset	3	C	High			

No.: 2		Bunker Station								
Item	Deviation	Causes	Consequences	Matrix	Severity	Likelihood	Risk	Safeguards	Recommendations	Comment
		3. Lightning/ Rain/ Thunderstorm	8. Poor visibility	Asset	2	B	Low	6. Restriction on weather envelop 7. Weather monitoring 8. No bunkering during lightening or thunderstorm	116. If bunkering done at night lighting requirement study to be conducted	
			9. Human injury	Injury	3	C	High			
			10. Fire/Explosion	Overall	S3-Moderate	LB-Unlikely	Moderate			
		4. Hose entanglement/ chaffing/contact with hull	2. Higher load on hose connection	Asset	3	B	Moderate	6. Restriction on weather envelop	112. Hose motion analysis to be performed considering transfer configuration to avoid any contact with hull or entanglement.	
			3. Damage to hose	Overall	S3-Moderate	LC-Possible	High			
		5. High waves hitting the bunker station (during voyage) and damaging bunker station (linked from 1.1)								
2.14	Berthing and mooring	1. Collision	2. Damage to Ship	Asset	3	B	Moderate	1. Training 2. H <sub>2</sub> tank meet IGF side penetration requirement	52. Detail bunker operation HAZID and risk assessment are to be conducted once detail design is available	
			3. Damage to H <sub>2</sub> tank/manifold	Overall	S4-Major	LA-Rare	High			

No.: 2		Bunker Station								
Item	Deviation	Causes	Consequences	Matrix	Severity	Likelihood	Risk	Safeguards	Recommendations	Comment
		2. Tide (change in elevation)	1. Damage to hose at key site (tide)	Asset	2	B	Low	3. Restriction for bunkering operation	52. Detail bunker operation HAZID and risk assessment are to be conducted once detail design is available 53. Operational envelop are to consider tide as one element impacting safety 115. bunk	

3	Hydrogen Storage System
Hydrogen Storage System	
CCPV tank design pressure 250 bar, design temperature -40 oC to 60 oC	

No.: 3		Hydrogen Storage System								
Item	Deviation	Causes	Consequences	Matrix	Severity	Likelihood	Risk	Safeguards	Recommendations	Comment
3.1	Tanks	1. Fatigue failure	1. H <sub>2</sub> leakage	Asset	3	C	High	1. Tank design to ISO standard with 10-time service life 2. Tank design for proper fatigue life and tested 3. Thermal protection provided - TPRD 4. Gas and fire detector 5. Fire detector 6. Design for leak before failure 7. Water spray system	20. Tank in service inspection and maintenance plan to be developed - as tank are consider uninspectable and there is only one connection to tank for loading/unloading H <sub>2</sub>  21. Consider providing Blowdown system for CCPV modules in case of fire/leak/damage to module 22. Consider during design such that any connection failure leakage resulting in leakage will not impinging on tank surface 24. Tank FMECA are to be performed considering all marine and operational loads 66. Electrical equipment located in H <sub>2</sub> Hazard are to be suitable for H <sub>2</sub>	
			2. Tank damage leading to explosion	Overall	S4-Major	LB-Unlikely	High			
			3. Jet fire	Asset	4	C	Extreme			
			7. Damage to tank	Overall	S4-Major	LB-Unlikely	High			

No.: 3		Hydrogen Storage System								
Item	Deviation	Causes	Consequences	Matrix	Severity	Likelihood	Risk	Safeguards	Recommendations	Comment
			17. Tank pressure rise (surrounding) due to heat gain	Asset	3	B	Moderate			
		2. High Temperature exposure due to nearby fire	2. Tank damage leading to explosion	Overall	S4-Major	LB-Unlikely	High	3. Thermal protection provided - TPRD 5. Fire detector 7. Water spray system 8. Vent system design to handle TPRD venting rate 9. Fire testing to check tank TPRD effectiveness and tank survivability	20. Tank in service inspection and maintenance plan to be developed - as tank are consider uninspectable and there is only one connection to tank for loading/unloading H <sub>2</sub>  21. Consider providing Blowdown system for CCPV modules in case of fire/leak/damage to module  54. Further study are to be conducted for effectiveness of H <sub>2</sub> fire detector in ice condition/low temperature atmospheric condition  56. Effectiveness of TPRD system for tank protection are to be further studied considering ice formation on TPRD element, rain and low atmospheric condition	
			4. Tank integrity compromise due to heat exposure (itself and surrounding tank)	Asset	4	B	High			
		3. Jet fire due to tank connection or piping connection leakage	2. Tank damage leading to explosion	Overall	S4-Major	LB-Unlikely	High	1. Tank design to ISO standard with 10-time service life	21. Consider providing Blowdown system for CCPV modules in case of fire/leak/damage to module	



No.: 3		Hydrogen Storage System								
Item	Deviation	Causes	Consequences	Matrix	Severity	Likelihood	Risk	Safeguards	Recommendations	Comment
							High	3. Thermal protection provided - TPRD 4. Gas and fire detector 5. Fire detector 6. Design for leak before failure 7. Water spray system 8. Vent system design to handle TPRD venting rate 9. Fire testing to check tank TPRD effectiveness and tank survivability	22. Consider during design such that any connection failure leakage resulting in leakage will not impinging on tank surface  56. Effectiveness of TPRD system for tank protection are to be further studied considering ice formation on TPRD element, rain and low atmospheric condition  66. Electrical equipment located in H <sub>2</sub> Hazard are to be suitable for H <sub>2</sub>	
			4. Tank integrity compromise due to heat exposure (itself and surrounding tank)	Asset	4	B	High			
			17. Tank pressure rise (surrounding) due to heat gain	Asset	3	B	Moderate			
		4. Marine load d (ship motion, wind, wave)	5. Higher load on tank module connection and deck connection - Two stack high is locked with twist lock. At deck also twist lock	Asset	3	C	High		57. Cargo tank module (ISO frame) to be design and connection are to withstand all marine load specified in IGF code  59. Tank support to ISO frame are to be designed for all marine load applicable	
			6. Module can be loose or fall off	Asset	3	C	High			
			7. Damage to tank	Overall	S4-Major	LB-Unlikely	High			
			8. Damage to tank support	Overall	S3-Moderate	LC-Possible	High			

No.: 3		Hydrogen Storage System								
Item	Deviation	Causes	Consequences	Matrix	Severity	Likelihood	Risk	Safeguards	Recommendations	Comment
			9. Damage to manifold	Overall	S3-Moderate	LC-Possible	High			
		5. High ship roll motion	5. Higher load on tank module connection and deck connection - Two stack high is locked with twist lock. At deck also twist lock	Asset	3	C	High		57. Cargo tank module (ISO frame) to be design and connection are to withstand all marine load specified in IGF code 58. Develop proper inspection plan for module connections 59. Tank support to ISO frame are to be designed for all marine load applicable	
			6. Module can be loose or fall off	Asset	3	C	High			
		6. Collision	1. H <sub>2</sub> leakage	Asset	3	C	High	10. ESD vale at tank to isolate inventory 11. Tank meet IGF code requirement for location	59. Tank support to ISO frame are to be designed for all marine load applicable 60. Tank module need to meet IGF interim guideline tank location criteria and should be away from potential damage penetration zone	
			2. Tank damage leading to explosion	Overall	S4-Major	LB-Unlikely	High			
			7. Damage to tank	Overall	S4-Major	LB-Unlikely	High			
			8. Damage to tank support	Overall	S3-Moderate	LC-Possible	High			
		7. Grounding <b>Comment:</b> No issue identified with pressurised fuel tank and storage								

No.: 3		Hydrogen Storage System								
Item	Deviation	Causes	Consequences	Matrix	Severity	Likelihood	Risk	Safeguards	Recommendations	Comment
		8. Dropped object	7. Damage to tank	Overall	S4-Major	LB-Unlikely	High	1. Tank design to ISO standard with 10-time service life	61. Dropped object study to be conducted and appropriate drop protection to be consider protecting tank, manifold and piping 72. System are to be designed to have blowdown capability to remove H <sub>2</sub> from system in case of total loss of ventilation	
			9. Damage to manifold	Overall	S3-Moderate	LC-Possible	High			
			14. Cargo Operations at port - Other vessel Operations (linked to 14.1)							
		9. Ice load	1. H <sub>2</sub> leakage	Asset	3	C	High	3. Thermal protection provided - TPRD 5. Fire detector	54. Further study are to be conducted for effectiveness of H <sub>2</sub> fire detector in ice condition/low temperature atmospheric condition 55. Consider manual blow down as backup to TPRD system 56. Effectiveness of TPRD system for tank protection are to be further studied considering ice formation on TPRD element, rain and low atmospheric condition 62. Tank manifold to be design or protected against ice formation and loads	

No.: 3		Hydrogen Storage System								
Item	Deviation	Causes	Consequences	Matrix	Severity	Likelihood	Risk	Safeguards	Recommendations	Comment
			9. Damage to manifold	Overall	S3-Moderate	LC-Possible	High			
		10. Green water on deck <b>Comment:</b> Vessel free board when fully loaded 3.5 meter	7. Damage to tank	Overall	S4-Major	LB-Unlikely	High	11. Tank meet IGF code requirement for location	63. Tank material are to be selected for exposure to sea/salt water 64. Consider all piping manifold installed to avoid green water exposure 117. Tank material to be tested for saltwater exposure	
			9. Damage to manifold	Overall	S3-Moderate	LC-Possible	High			
			10. Salty water can damage tank material	Asset	3	C	High			
		11. Deck opening under H <sub>2</sub> tank	11. Obstruction	Asset	3	C	High		65. Cargo Tank opening are to be studied and if needed need to be moved for accessibility etc.	
		12. Hazardous zone due to H <sub>2</sub> tank and manifolds	12. all cargo and deck electrical equipment not suitable for H <sub>2</sub>	Asset	3	C	High		66. Electrical equipment located in H <sub>2</sub> Hazard are to be suitable for H <sub>2</sub>	
		13. Helicopter drop area between two tank module fwd. - Dropped area is 2.5 m lower than H <sub>2</sub> tank top <b>Comment:</b> Operation happen during rough weather, high wind. which can lead to high swing of dropped object	15. Swing motion can hit H <sub>2</sub> tank, leads to tank damage and H <sub>2</sub> release.	Overall	S4-Major	LB-Unlikely	High		99. Further study are to be conducted for drop point and helicopter operation considering H <sub>2</sub> storage, TCS space and other H <sub>2</sub> equipment/piping	

No.: 3		Hydrogen Storage System								
Item	Deviation	Causes	Consequences	Matrix	Severity	Likelihood	Risk	Safeguards	Recommendations	Comment
			16. Dropped area is 2.5 m lower than H <sub>2</sub> tank top	Asset	3	C	High			
		14. TCS connection and manifolding of tanks on each module and between module to make as one tank - Hydrogen Tank Connections & System (linked from 4.1)								
3.2	Tank Structural Interface	1. End support failure <b>Comment:</b> Tank are installed in ISO 40' frame. It is designed for road transportation with 3g/2g loads which exceed marine dynamic loads. Tanks one end if fixed and other end is floating	1. Leakage and explosion	Asset	3	B	Moderate	1. Tank is design for 3g/2g road transportation load 2. Design for IGF code define marine loads	23. Tanks support are to be design per IGF coed marine load requirements 24. Tank FMECA are to be performed considering all marine and operational loads	
		2. ISO frame to hull interface failure marine load, excessive roll etc.	2. Loss of CCPV module	Asset	3	C	High	2. Design for IGF code define marine loads	23. Tanks support are to be design per IGF coed marine load requirements 24. Tank FMECA are to be performed considering all marine and operational loads	
3.3	Supports									No additional issue identified. Tank support frame design to 33/2g/2g load

4	Hydrogen Tank Connections & System
Hydrogen Tank Connections & System	

No.: 4		Hydrogen Tank Connections & System								
Item	Deviation	Causes	Consequences	Matrix	Severity	Likelihood	Risk	Safeguards	Recommendations	Comment
4.1	TCS connection and manifolding of tanks on each module and between module to make as one tank	1. Wave/Green Water	2. Tanks - Hydrogen Storage System (linked to 3.1)						69. Ventilation analysis and gas dispersion analysis are to be performed for air inlet/outlet location, gas detector mapping and optimal layout to avoid any possibility of H <sub>2</sub> accumulation inside space 118. Consider enclosed Tank connection space with ventilation etc. to protect against ice, green water, wave etc.	
		2. Dropped object	2. Tanks - Hydrogen Storage System (linked to 3.1)						5. Dropped objects studies to be performed considering H <sub>2</sub> equipment/piping in zone of lift and appropriate drop protection are to be provided	
		3. Fatigue, corrosion etc.	2. Tanks - Hydrogen Storage System (linked to 3.1)						118. Consider enclosed Tank connection space with ventilation etc. to protect against ice, green water, waves etc. 119. Material selection to resist marine environment, sea water	
		4. Ice load	2. Tanks - Hydrogen Storage System (linked to 3.1)							
		5. Hull deflection, ship motion	1. Damage to tank, fire, explosion	Overall	S3-Moderate	LC-Possible	High	1. See 3.1		

<b>No.:</b> 4		Hydrogen Tank Connections & System								
<b>Item</b>	<b>Deviation</b>	<b>Causes</b>	<b>Consequences</b>	<b>Matrix</b>	<b>Severity</b>	<b>Likelihood</b>	<b>Risk</b>	<b>Safeguards</b>	<b>Recommendations</b>	<b>Comment</b>
			2. Tanks - Hydrogen Storage System (linked to 3.1)							

5	Fuel Preparation System
Fuel Preparation System	

No.: 5		Fuel Preparation System								
Item	Deviation	Causes	Consequences	Matrix	Severity	Likelihood	Risk	Safeguards	Recommendations	Comment
5.1	General	1. Piping leakage/failure <b>Comment:</b> HP and LP vents are to be separated - Total four TCS space and one pressure reduction / distribution station. All piping welded as far as possible	1. Potential for fire/explosion	Asset	4	B	High	1. Continuous ventilation (30 air change) 2. H <sub>2</sub> and fire detection 3. ESD 4. Blowdown system to vent hydrogen	5. Dropped objects studies to be performed considering H <sub>2</sub> equipment/piping in zone of lift and appropriate drop protection are to be provided 9. Consider conducting proper vibration analysis and support to mitigate vibration be provided 11. At detailed design stage perform HAZOP and FMEA for piping systems and controls 73. Further study to be done considering pressure reduction at TCS space or at final pressure reduction station. The issue is to run HP H <sub>2</sub> piping on deck or only LP H <sub>2</sub> piping on deck except bunker line. 74. Piping stress analysis to be performed for all operational condition	
			2. Hydrogen in ER/FPS etc.	Asset	3	C	High			



No.: 5		Fuel Preparation System								
Item	Deviation	Causes	Consequences	Matrix	Severity	Likelihood	Risk	Safeguards	Recommendations	Comment
		2. Shut down of system/engine <b>Comment:</b> Upon shutdown system will be vented to minimise risk	1. Potential for fire/explosion	Asset	4	B	High	3. ESD 4. Blowdown system to vent hydrogen	11. At detailed design stage perform HAZOP and FMEA for piping systems and controls 73. Further study to be done considering pressure reduction at TCS space or at final pressure reduction station. The issue is to run HP H <sub>2</sub> piping on deck or only LP H <sub>2</sub> piping on deck except bunker line. 74. Piping stress analysis to be performed for all operational condition	
			3. Hydrogen locked in system	Asset	3	B	Moderate			
		3. Normal start up and shut down	3. Hydrogen locked in system	Asset	3	B	Moderate	4. Blowdown system to vent hydrogen	11. At detailed design stage perform HAZOP and FMEA for piping systems and controls 73. Further study to be done considering pressure reduction at TCS space or at final pressure reduction station. Issue is to run HP H <sub>2</sub> piping on deck or only LP H <sub>2</sub> piping on deck except bunker line.	
5.2	double wall piping	1. double wall piping - Hydrogen Supply Piping (linked from 6.1)								Comply with IGF requirement

6	Hydrogen Supply Piping
<p>Hydrogen Supply Piping                  Rene's Presentation: 200 bar but 250 bar can be done. There is only one isolation and release valve for all tanks. There is also a ruptured disk. There is no compression on the ship. The GVU is the same diagram for all 3 engine systems. TPRD valve once is activated the cargo of the tank is discharged. The required temperature in the GVU hydrogen is arriving no more than 30 °C and 10 bar. there min temperature is zero degrees. Operation is foreseen in northern Europe where temperatures are very low so the min temp should be reconsidered.</p> <p>Supply pressure 10 bar in inner wall. Annulus space is continuously vented</p> <p>Dry air to be used for annulus venting</p> <p>For pressurised annulus space, ship has no N<sub>2</sub> supply available at pressure require</p> <p>Individual supply line to each GVU. Each consumer has its own GVU. Supply pipe double wall</p> <p>Master shutoff valve in FPR room</p>	

No.: 6		Hydrogen Supply Piping								
Item	Deviation	Causes	Consequences	Matrix	Severity	Likelihood	Risk	Safeguards	Recommendations	Comment
6.1	double wall piping	1. Inner pipe fail <b>Comment:</b> Continuously vented annulus space	1. H <sub>2</sub> in annulus	Asset	2	C	Moderate	1. Annulus is continuously vented 2. H <sub>2</sub> Detector for annulus space 3. ESD 4. Purging of H <sub>2</sub> lines 9. Design to meet IGF code requirement 10. Dual fuel engine to switch over	70. Material are to be selected for H <sub>2</sub> service and marine environment considering green water effect 75. Consider Testing of annulus space(outer pipe tightness) - with He or H <sub>2</sub> id annulus is continuously vented 76. Further study to be conducted for Annulus pressurised vs continuously vented option 77. Ventilation rate study to be conducted considering maximum leak rate	Supply pressure 10 bar in inner wall. Annulus space is continuously vented

No.: 6		Hydrogen Supply Piping								
Item	Deviation	Causes	Consequences	Matrix	Severity	Likelihood	Risk	Safeguards	Recommendations	Comment
									122. Due to wide flammability range and low ignition energy possibility of deflagration /detonation exist, further study require if air venting is proposed for annulus to minimise such potential design outer/inner pipe to withstand deflagration /detonation	
			3. If inner pipe fail possibility of H <sub>2</sub> in engine room	Asset	3	A	Moderate			
			7. Deflagration /detonation (if air circulation in annulus)	Overall	S4-Major	LC-Possible	Extreme			
			8. Loss of H <sub>2</sub> supply to engine	Overall	S3-Moderate	LB-Unlikely	Moderate			
		2. Outer pipe fail	2. Loss of air ventilation	Overall	S3-Moderate	LB-Unlikely	Moderate	5. Pressure differential measurement 6. Flow measurement and switch 7. H <sub>2</sub> detector in engine room 9. Design to meet IGF code requirement	78. Develop proper maintenance procedure for outer and inner pipe and testing	
			3. If inner pipe fail possibility of H <sub>2</sub> in engine room	Asset	3	A	Moderate			
		3. Moisture in air	4. Condensation in annulus	Asset	2	C	Moderate	8. Ventilation air is Dry and dew point control		
			5. Corrosion of piping	Asset	3	B	Moderate			

7	Engine
<p>Presentation by E.P regarding the cascading during the operation of the engine. Dual fuel technology. Otto cycle; hydrogen is injected before the admission valve, during the admission stroke. Effect of knocking. The engine control unit is used for the monitoring and protection of the engine. There is control of hydrogen/diesel injection in function of the load required rpm. There is automatic switch to diesel in case of compromise on hydrogen related safety.</p> <p>GVU H<sub>2</sub> inlet 10 bar and reduce pressure between 4 to 6 bar</p> <p>Emergency Genset is not dual fuelled/no H<sub>2</sub> GVU is located close to consumer inside machinery space</p> <p>Crank case is maintained under pressure</p>	

No.: 7		Engine								
Item	Deviation	Causes	Consequences	Matrix	Severity	Likelihood	Risk	Safeguards	Recommendations	Comment
7.1	GVU	1. Circulation air (moisture)	3. Condensation inside enclosure	Asset	3	B	Moderate	3. Material is selected to avoid corrosion 4. Purge air will be dry air and dew point control		
			4. Corrosion	Asset	3	B	Moderate			
		2. H <sub>2</sub> leak inside enclosure <b>Comment:</b> GVU is continuously vented with Air. GVU enclosure is design to withstand worst case blast load	1. H <sub>2</sub> in enclosure	Asset	2	D	High	1. Continuous ventilation (15 air change/hr.) 2. Air inlet and outlet is outside machinery space	79. Design criteria for enclosure are to be further studied considering H <sub>2</sub> leak inside enclosure 80. Enclosure ventilation rate are to be further study - consider IEC guideline/ NFPA 81. Consider providing H <sub>2</sub> detector for each GVU 82. Consider providing separate ventilation system for DG and Main Engine	

No.: 7		Engine								
Item	Deviation	Causes	Consequences	Matrix	Severity	Likelihood	Risk	Safeguards	Recommendations	Comment
							High		83. Consider designing Engine room GUV to withstand internal deflagration /detonation and consider deflagration protection criteria 123. Vents from GUV consider Hazardous and need further study for location where to vent	
			2. Fire and explosion	Overall	S3-Moderate	LC-Possible	High			
7.2	H <sub>2</sub> in crank case	1. Crown failure	1. H <sub>2</sub> in crank case(cartridge)	Asset	4	B	High	1. Oil mist detector inside crank case 2. Pressure measurement to detect H <sub>2</sub> migration 3. Crank case (cartridge) maintain under pressure and upon loss of under pressure will shut down engine 4. Explosion relief valve	84. Engine manufacturer to further study H <sub>2</sub> detection in crank case(carter) 85. Explosion relief discharge are to be further study in case unburnt H <sub>2</sub> comes out of explosion relief 86. Engine component and its control system FMECA are to be performed	
			2. Crank case explosion	Asset	3	C	High			
		2. Broken piston ring	1. H <sub>2</sub> in crank case(cartridge)	Asset	4	B	High	1. Oil mist detector inside crank case 2. Pressure measurement to detect H <sub>2</sub> migration		

No.: 7		Engine								
Item	Deviation	Causes	Consequences	Matrix	Severity	Likelihood	Risk	Safeguards	Recommendations	Comment
								3. Crank case (cartridge) maintain under pressure and upon loss of under pressure will shut down engine 4. Explosion relief valve		
			2. Crank case explosion	Asset	3	C	High			
		3. Miss timing on injection <b>Comment:</b> Need further evaluation								
7.3	H <sub>2</sub> in cooling water	1. Liner failure	1. H <sub>2</sub> /combustion product in water circuit	Asset	2	C	Moderate	1. Cooling water has expansion tank	87. Expansion tank vent line to be routed to proper location	
		2. Valve seat failure	1. H <sub>2</sub> /combustion product in water circuit	Asset	2	C	Moderate	1. Cooling water has expansion tank	87. Expansion tank vent line to be routed to proper location 88. Consider providing H <sub>2</sub> detector on expansion tank or alternate means	
7.4	H <sub>2</sub> flow to air intake	1. Valve seat failure	1. H <sub>2</sub> in air side	Asset	3	C	High	2. Engine control system monitor combustion, timing, rpm, output etc. 3. EG control monitor temperature 4. Air intake is design to withstand explosion 5. Dual fuel switch over - diesel 6. H <sub>2</sub> system vented		

No.: 7		Engine								
Item	Deviation	Causes	Consequences	Matrix	Severity	Likelihood	Risk	Safeguards	Recommendations	Comment
		2. Miss timing in H <sub>2</sub> injection	1. H <sub>2</sub> in air side	Asset	3	C	High	1. H <sub>2</sub> detector in EG 2. Engine control system monitor combustion, timing, rpm, output etc. 3. EG control monitor temperature 4. Air intake is design to withstand explosion 5. Dual fuel switch over - diesel 6. H <sub>2</sub> system vented	86. Engine component and its control system FMECA are to be performed	
7.5	Unburned H <sub>2</sub> in Exhaust receiver and exhaust system	1. Incomplete combustion	1. H <sub>2</sub> is exhaust/chamber	Asset	2	C	Moderate	1. H <sub>2</sub> detector in EG 2. Engine control system monitor combustion, timing, rpm, output etc. 3. EG control monitor temperature 4. Exhaust is designed to withstand explosion in exhaust? or explosion relief valve 5. Dual fuel switch over - diesel 6. H <sub>2</sub> system vented		
			2. Explosion in exhaust	Asset	3	C	High			
			3. GHG emission	Environmental	2	C	Moderate			
			4. H <sub>2</sub> can leak in ER from exhaust	Overall	S3-Moderate	LC-Possible	High			

No.: 7		Engine								
Item	Deviation	Causes	Consequences	Matrix	Severity	Likelihood	Risk	Safeguards	Recommendations	Comment
		2. Miss firing	1. H <sub>2</sub> is exhaust/chamber	Asset	2	C	Moderate	1. H <sub>2</sub> detector in EG 2. Engine control system monitor combustion, timing, rpm, output etc. 3. EG control monitor temperature 4. Exhaust is designed to withstand explosion in exhaust? or explosion relief valve 5. Dual fuel switch over - diesel 6. H <sub>2</sub> system vented	86. Engine component and its control system FMECA are to be performed	
			2. Explosion in exhaust	Asset	3	C	High			
			3. GHG emission	Environmental	2	C	Moderate			
			4. H <sub>2</sub> can leak in ER from exhaust	Overall	S3-Moderate	LC-Possible	High			
		3. Exhaust valve leakage	1. H <sub>2</sub> is exhaust/chamber	Asset	2	C	Moderate	1. H <sub>2</sub> detector in EG 2. Engine control system monitor combustion, timing, rpm, output etc. 3. EG control monitor temperature 4. Exhaust is designed to withstand explosion in exhaust? or explosion relief valve 5. Dual fuel switch over - diesel	86. Engine component and its control system FMECA are to be performed 124. Engine exhaust to be further evaluated for explosion potential	



No.: 7		Engine								
Item	Deviation	Causes	Consequences	Matrix	Severity	Likelihood	Risk	Safeguards	Recommendations	Comment
								6. H <sub>2</sub> system vented		
			2. Explosion in exhaust	Asset	3	C	High			
			3. GHG emission	Environmental	2	C	Moderate			
			4. H <sub>2</sub> can leak in ER from exhaust	Overall	S3-Moderate	LC-Possible	High			
		4. Miss timing of injection of H <sub>2</sub>							86. Engine component and its control system FMECA are to be performed 124. Engine exhaust to be further evaluated for explosion potential	
		5. H <sub>2</sub> injector malfunction	1. H <sub>2</sub> is exhaust/chamber	Asset	2	C	Moderate	1. H <sub>2</sub> detector in EG 2. Engine control system monitor combustion, timing, rpm, output etc. 3. EG control monitor temperature 4. Exhaust is designed to withstand explosion in exhaust? or explosion relief valve 5. Dual fuel switch over - diesel 6. H <sub>2</sub> system vented	86. Engine component and its control system FMECA are to be performed 124. Engine exhaust to be further evaluated for explosion potential	
			2. Explosion in exhaust	Asset	3	C	High			
			3. GHG emission	Environmental	2	C	Moderate			
			4. H <sub>2</sub> can leak in ER from exhaust	Overall	S3-Moderate	LC-Possible	High			

No.: 7		Engine								
Item	Deviation	Causes	Consequences	Matrix	Severity	Likelihood	Risk	Safeguards	Recommendations	Comment
7.6	Lube Oil	1. No issue identify <b>Comment:</b> It is self-contain system inside engine	1. 2 Hydrogen Powered - Genset (linked to 8.1)							
7.7	Cylinder cover lifting	1. Early ignition in combustion chamber	1. Exhaust gas in Engine room	Asset	3	C	High	1. Engine control system 2. Pressure relief valve on head	90. Issue need to be further study for impact of any H <sub>2</sub> leak inside ER. 125. Further study to be conducted for any possibility of H <sub>2</sub> in ER due to engine issue and consideration to be providing H <sub>2</sub> detector and appropriate measure to reduce risk	
			2. Unburnt H <sub>2</sub> in engine room	Asset	4	B	High			
		2. Early Ignition in combustion chamber (linked from 7.8)								
7.8	Early Ignition in combustion chamber	1. Pre ignition due to high temperature	1. Damage to component	Asset	3	B	Moderate	1. Other engine available ship can operate at reduced power 2. Monitoring combustion temp. and if it is outside normal range initiate shutdown 3. Knock detection		
			3. Temperature increase	Asset	2	C	Moderate			
			4. Cylinder damage	Asset	2	C	Moderate			
			5. High flam speed	Asset	2	B	Low			
			6. Loss of engine	Asset	3	B	Moderate			

8	Genset
Genset	

No.: 8		Genset								
Item	Deviation	Causes	Consequences	Matrix	Severity	Likelihood	Risk	Safeguards	Recommendations	Comment
8.1	2 Hydrogen Powered	1. GVU - Engine (linked from 7.1) <b>Comment:</b> Similar to Engine failure see node 7 2. H <sub>2</sub> in crank case - Engine (linked from 7.2) 3. H <sub>2</sub> in cooling water - Engine (linked from 7.3) 4. H <sub>2</sub> flow to air intake - Engine (linked from 7.4) 5. Unburned H <sub>2</sub> in Exhaust receiver and exhaust system - Engine (linked from 7.5) 6. Lube Oil - Engine (linked from 7.6) 7. Cylinder cover lifting - Engine (linked from 7.7) 8. Early Ignition in combustion chamber - Engine (linked from 7.8)							89. Exhaust from Genset are to be separated from main engine exhaust 126. Gen set compartment H <sub>2</sub> safety to be design similar to ER	

9	Ventilation System
Ventilation System	

No.: 9		Ventilation System								
Item	Deviation	Causes	Consequences	Matrix	Severity	Likelihood	Risk	Safeguards	Recommendations	Comment
9.1	General	1. H <sub>2</sub> leakage (connection leakage, gasket failure, vibration, improper connection) <b>Comment:</b> Space to be maintained at -ve pressure	1. Hazardous atmosphere inside space	Asset	2	D	High	1. Continuous ventilation 2. Electrical equipment are certified for use in H <sub>2</sub> 3. H <sub>2</sub> detector 4. Fire detector 5. Power supply normal and emergency for ventilation system	43. Maintenance FMECA are to be done for H <sub>2</sub> system 68. Consider piping to meet leak before fail criteria 69. Ventilation analysis and gas dispersion analysis are to be performed for air inlet/outlet location, gas detector mapping and optimal layout to avoid any possibility of H <sub>2</sub> accumulation inside space 71. Valve and other equipment, seals etc. to be selected based on fugitive emission minimization 127. Ventilation system to be reevaluated once more information is available 131. Local small jet fire can exist from very small leak. Proper study to be performed to detect such fire. Proper PPE and training to be developed	No info available at this stage
			2. Jet fire	Overall	S3-Moderate	LC-Possible	High			

No.: 9		Ventilation System								
Item	Deviation	Causes	Consequences	Matrix	Severity	Likelihood	Risk	Safeguards	Recommendations	Comment
			3. Explosion	Asset	3	B	Moderate			
		2. Fugitive emission	1. Hazardous atmosphere inside space	Asset	2	D	High	1. Continuous ventilation 2. Electrical equipment are certified for use in H <sub>2</sub> 3. H <sub>2</sub> detector 6. ESD 7. Blowdown automatic or manual	69. Ventilation analysis and gas dispersion analysis are to be performed for air inlet/outlet location, gas detector mapping and optimal layout to avoid any possibility of H <sub>2</sub> accumulation inside space  71. Valve and other equipment, seals etc. to be selected based on fugitive emission minimization	
			4. Environmental emission	Environmental	2	D	High			
		3. Loss of ventilation	1. Hazardous atmosphere inside space	Asset	2	D	High	3. H <sub>2</sub> detector 4. Fire detector 5. Power supply normal and emergency for ventilation system 6. ESD 7. Blowdown automatic or manual	72. System are to be designed to have blowdown capability to remove H <sub>2</sub> from system in case of total loss of ventilation  127. Ventilation system to be reevaluated once more information is available	

10	Venting System & vents
<p>Venting System &amp; vents</p> <p>Low pressure                  Double wall pipe                  Engine -                  GVU                  Fuel supply piping to engine between master shutoff valve and engine                  Expansion tank vents                  Crank case vent</p> <p>All low pressure H<sub>2</sub> vents are routed through funnel and extended above engine/Genset exhaust team do not see this as problem</p>	

No.: 10		Venting System & vents								
Item	Deviation	Causes	Consequences	Matrix	Severity	Likelihood	Risk	Safeguards	Recommendations	Comment
10.1	Low pressure Vent system	1. Shut down of system/engine <b>Comment:</b> Upon shutdown system will be vented to minimise risk	1. H <sub>2</sub> gas in vent	Asset	1	D	Moderate	1. Vent line routed to safe place above casing and exhaust 2. LP/HP vent line need to have H <sub>2</sub> detector 3. Manual/automatic blowdown system 4. Gas vented to safe place	3. Conduct Fire Hazards Analysis, Gas Dispersion Analysis, Explosion Analysis to establish hazardous area zones and hazardous impact. Provide appropriate mitigations for fire and explosion consequences. Evaluate if the vessel structural damage due to explosion can compromise the Cargo tank integrity. Evaluate the vent mast design and hazardous area zone established by the vent mast.  29. Hazardous areas around vent mast are to be specified per gas dispersion analysis (typically it is 15ft.) and applicable codes and standards	

No.: 10		Venting System & vents								
Item	Deviation	Causes	Consequences	Matrix	Severity	Likelihood	Risk	Safeguards	Recommendations	Comment
									38. All LP vent are to be further studies for combining all in one vent or keep certain vent separate (e.g. crank case vent, GUV vents, fuel supply line from FPR)) 120. Due to wide flammability and low ignition energy require, the risk of deflagration /detonation exists if air ingress occurs inside vent lines. Further studies are to be conducted to avoid such potential. (e.g. N <sub>2</sub> continuous purge, design pipe to withstand deflagration /detonation pressure 128. High pressure high flow vents are to be separated from low pressure low flow vent system to avoid any back pressure issue. Vent and relief capacity study to be conducted 129. Consider providing H <sub>2</sub> detector on all vent lines	
			2. Hazardous atmosphere at vent stack outlet	Asset	1	D	Moderate			
			3. Vent stack fire/explosion	Asset	3	C	High			
			4. Potential for fire/explosion inside vent lines	Asset	4	C	Extreme			

No.: 10		Venting System & vents								
Item	Deviation	Causes	Consequences	Matrix	Severity	Likelihood	Risk	Safeguards	Recommendations	Comment
		2. Normal start up and shut down	1. H <sub>2</sub> gas in vent	Asset	1	D	Moderate	1. Vent line routed to safe place above casing and exhaust 2. LP/HP vent line need to have H <sub>2</sub> detector 3. Manual/automatic blowdown system 4. Gas vented to safe place	3. Conduct Fire Hazards Analysis, Gas Dispersion Analysis, Explosion Analysis to establish hazardous area zones and hazardous impact. Provide appropriate mitigations for fire and explosion consequences. Evaluate if the vessel structural damage due to explosion can compromise the Cargo tank integrity. Evaluate the vent mast design and hazardous area zone established by the vent mast.  29. Hazardous areas around vent mast are to be specified per gas dispersion analysis (typically it is 15ft.) and applicable codes and standards  38. All LP vent are to be further studies for combining all in one vent or keep certain vent separate (e.g. crank case vent, GUV vents, fuel supply line from FPR))	



No.: 10		Venting System & vents								
Item	Deviation	Causes	Consequences	Matrix	Severity	Likelihood	Risk	Safeguards	Recommendations	Comment
									120. Due to wide flammability and low ignition energy require, the risk of deflagration /detonation exists if air ingress occurs inside vent lines. Further studies are to be conducted to avoid such potential. (e.g. N <sub>2</sub> continuous purge, design pipe to withstand deflagration /detonation pressure 128. High pressure high flow vents are to be separated from low pressure low flow vent system to avoid any back pressure issue. Vent and relief capacity study to be conducted 129. Consider providing H <sub>2</sub> detector on all vent lines	
			2. Hazardous atmosphere at vent stack outlet	Asset	1	D	Moderate			
			3. Vent stack fire/explosion	Asset	3	C	High			
			4. Potential for fire/explosion inside vent lines	Asset	4	C	Extreme			

No.: 10		Venting System & vents								
Item	Deviation	Causes	Consequences	Matrix	Severity	Likelihood	Risk	Safeguards	Recommendations	Comment
		3. Venting from crank case	1. H <sub>2</sub> gas in vent	Asset	1	D	Moderate	1. Vent line routed to safe place above casing and exhaust 2. LP/HP vent line need to have H <sub>2</sub> detector 3. Manual/automatic blowdown system 4. Gas vented to safe place	3. Conduct Fire Hazards Analysis, Gas Dispersion Analysis, Explosion Analysis to establish hazardous area zones and hazardous impact. Provide appropriate mitigations for fire and explosion consequences. Evaluate if the vessel structural damage due to explosion can compromise the Cargo tank integrity. Evaluate the vent mast design and hazardous area zone established by the vent mast.  29. Hazardous areas around vent mast are to be specified per gas dispersion analysis (typically it is 15ft.) and applicable codes and standards  38. All LP vent are to be further studies for combining all in one vent or keep certain vent separate (e.g. crank case vent, GUV vents, fuel supply line from FPR))	

No.: 10		Venting System & vents								
Item	Deviation	Causes	Consequences	Matrix	Severity	Likelihood	Risk	Safeguards	Recommendations	Comment
									120. Due to wide flammability and low ignition energy require, the risk of deflagration /detonation exists if air ingress occurs inside vent lines. Further studies are to be conducted to avoid such potential. (e.g. N <sub>2</sub> continuous purge, design pipe to withstand deflagration /detonation pressure 128. High pressure high flow vents are to be separated from low pressure low flow vent system to avoid any back pressure issue. Vent and relief capacity study to be conducted 129. Consider providing H <sub>2</sub> detector on all vent lines	
			2. Hazardous atmosphere at vent stack outlet	Asset	1	D	Moderate			
			3. Vent stack fire/explosion	Asset	3	C	High			
			4. Potential for fire/explosion inside vent lines	Asset	4	C	Extreme			

No.: 10		Venting System & vents								
Item	Deviation	Causes	Consequences	Matrix	Severity	Likelihood	Risk	Safeguards	Recommendations	Comment
		4. Vents from Expansion tank	1. H <sub>2</sub> gas in vent	Asset	1	D	Moderate	1. Vent line routed to safe place above casing and exhaust 2. LP/HP vent line need to have H <sub>2</sub> detector 3. Manual/automatic blowdown system 4. Gas vented to safe place	3. Conduct Fire Hazards Analysis, Gas Dispersion Analysis, Explosion Analysis to establish hazardous area zones and hazardous impact. Provide appropriate mitigations for fire and explosion consequences. Evaluate if the vessel structural damage due to explosion can compromise the Cargo tank integrity. Evaluate the vent mast design and hazardous area zone established by the vent mast.  29. Hazardous areas around vent mast are to be specified per gas dispersion analysis (typically it is 15ft.) and applicable codes and standards  38. All LP vent are to be further studies for combining all in one vent or keep certain vent separate (e.g. crank case vent, GUV vents, fuel supply line from FPR))	

No.: 10		Venting System & vents								
Item	Deviation	Causes	Consequences	Matrix	Severity	Likelihood	Risk	Safeguards	Recommendations	Comment
									120. Due to wide flammability and low ignition energy require, the risk of deflagration /detonation exists if air ingress occurs inside vent lines. Further studies are to be conducted to avoid such potential. (e.g. N <sub>2</sub> continuous purge, design pipe to withstand deflagration /detonation pressure 128. High pressure high flow vents are to be separated from low pressure low flow vent system to avoid any back pressure issue. Vent and relief capacity study to be conducted 129. Consider providing H <sub>2</sub> detector on all vent lines	
			2. Hazardous atmosphere at vent stack outlet	Asset	1	D	Moderate			
			3. Vent stack fire/explosion	Asset	3	C	High			
			4. Potential for fire/explosion inside vent lines	Asset	4	C	Extreme			
10.2	High pressure	1. Discharge from PRV - bunker, FP system etc.	1. H <sub>2</sub> discharge from HP Vent mast	Asset	2	C	Moderate	1. H <sub>2</sub> detector in vent mast 2. Water spray on Type C CCPV tank 3. Manned operation 4. HP alarm and shutdown	29. Hazardous areas around vent mast are to be specified per gas dispersion analysis (typically it is 15ft.) and applicable codes and standards	

No.: 10		Venting System & vents								
Item	Deviation	Causes	Consequences	Matrix	Severity	Likelihood	Risk	Safeguards	Recommendations	Comment
								5. Training and procedure	30. Vent mast can ingress air and leads to back splash or detonation inside vent mast. Vent mast are to be designed to withstand such load to avoid damage Typically design for 200 psi 31. Vent mast to design to avoid water ingress 32. Vent mast piping are to be designed to avoid any high spot where H <sub>2</sub> can accumulate 33. Vent mast are to be fully welded construction to avoid any leakage 34. Vent mast to be checked for Bridge visibility and compliance to regulation 35. Vent mast capacity are to be design based on maximum amount of H <sub>2</sub> that can be discharge in TPRD event due to fire near tank or jet fire impinging on tank 94. Detail gas dispersion, fire/explosion analysis, radian heat load is to be conducted considering various discharge rates and fire situation to vent mast (HP and LP) or local discharge	

No.: 10		Venting System & vents								
Item	Deviation	Causes	Consequences	Matrix	Severity	Likelihood	Risk	Safeguards	Recommendations	Comment
			2. Vent mast fire	Asset	2	C	Moderate			
			3. Radiant heat damaging CCPV tank and other equipment	Asset	4	C	Extreme			
			4. Vent Mast internal deflagration/detonation	Asset	4	C	Extreme			
		2. Discharge form TPRD due to fire/radiant heat etc. <b>Comment:</b> Due to fire TPRD is activated to protect tank	1. H <sub>2</sub> discharge from HP Vent mast	Asset	2	C	Moderate	1. H <sub>2</sub> detector in vent mast 2. Water spray on Type C CCPV tank	29. Hazardous areas around vent mast are to be specified per gas dispersion analysis (typically it is 15ft.) and applicable codes and standards 30. Vent mast can ingress air and leads to back splash or detonation inside vent mast. Vent mast are to be designed to withstand such load to avoid damage Typically design for 200 psi 31. Vent mast to design to avoid water ingress 32. Vent mast piping are to be designed to avoid any high spot where H <sub>2</sub> can accumulate 33. Vent mast are to be fully welded construction to avoid any leakage 34. Vent mast to be checked for Bridge visibility and compliance to regulation	

No.: 10		Venting System & vents								
Item	Deviation	Causes	Consequences	Matrix	Severity	Likelihood	Risk	Safeguards	Recommendations	Comment
									35. Vent mast capacity are to be design based on maximum amount of H <sub>2</sub> that can be discharge in TPRD event due to fire near tank or jet fire impinging on tank 37. Consider protecting vent lines in case of fire by providing water spray or other means in TPRD event	
			2. Vent mast fire	Asset	2	C	Moderate			
			3. Radiant heat damaging CCPV tank and other equipment	Asset	4	C	Extreme			
			4. Vent Mast internal deflagration/detonation	Asset	4	C	Extreme			
		3. Interference with Cargo vent mast <b>Comment:</b> Proposal is to run H <sub>2</sub> vent and cargo vent side by side	5. Cargo vent can enter H <sub>2</sub> vent mast	Asset	3	C	High		36. compatibility check are to be done between H <sub>2</sub> and cargo carried to avoid any issue 130. Further study to be performed in cargo vent content enter in H <sub>2</sub> vent lines	



11	Safety System
Safety System	

No.: 11		Safety System								
Item	Deviation	Causes	Consequences	Matrix	Severity	Likelihood	Risk	Safeguards	Recommendations	Comment
11.1	ESD & Isolation	1. General <b>Comment:</b> Design in early stage no information available at this stage								
11.2	Pressure Relief	1. Tanks - Hydrogen Storage System (linked from 3.1)								
11.3	F&G Detection	1. General <b>Comment:</b> At this stage, no information available								

12	Firefighting Systems
Firefighting Systems	

<b>No.:</b> 12		Firefighting Systems								
Item	Deviation	Causes	Consequences	Matrix	Severity	Likelihood	Risk	Safeguards	Recommendations	Comment
12.1	New	1. General <b>Comment:</b> No information available at this time							37. Consider protecting vent lines in case of fire by providing water spray or other means in TPRD event	

13	Other Operating Modes
Other Operating Modes	
Quick load change possible with otto cycle? Change in load is adjusted by injecting more pi fuel - diesel. Ship is fixed pitch propeller	

No.: 13		Other Operating Modes								
Item	Deviation	Causes	Consequences	Matrix	Severity	Likelihood	Risk	Safeguards	Recommendations	Comment
13.1	Startup	1. General							92. Engine manufacturer to collect data on H <sub>2</sub> slip and other combustion product during type testing and provide data to owner and class society  100. For all normal operation any emission/venting of H <sub>2</sub> are to be consider as GHG and to be accounted purging, degassing, gassing up, shutdown, normal blowdown etc.	
13.2	Shutdown	1. General`								
13.3	Voyage									
13.4	Dry docking	1. Degassing of system <b>Comment:</b> N <sub>2</sub> generator can provide 99.9% pure N <sub>2</sub> . <1% O <sub>2</sub>							91. Gassing up, degassing procedure are to be developed and appropriate instrument/ sampling point to be provided to verify operation  93. Capacity and N <sub>2</sub> requirement for all operational needs are to be studied and appropriate N <sub>2</sub> capacity are to be provided	

No.: 13		Other Operating Modes								
Item	Deviation	Causes	Consequences	Matrix	Severity	Likelihood	Risk	Safeguards	Recommendations	Comment
		2. gassing up							91. Gassing up, degassing procedure are to be developed and appropriate instrument/ sampling point to be provided to verify operation 93. Capacity and N <sub>2</sub> requirement for all operational needs are to be studied and appropriate N <sub>2</sub> capacity are to be provided	
13.5	Heavy weather condition	1. Heavy weather require quick load changes on engine <b>Comment:</b> Quick load change possible with otto cycle? Change in load is adjusted by injecting diesel. Ship is fixed pitch propeller	1. Low power	Overall	S3-Moderate	LC-Possible	High	1. Adjustment of pilot fuel to adjust load 2. Engine control will monitor critical parameter for combustion and adjust accordingly	92. Engine manufacturer to collect data on H <sub>2</sub> slip and other combustion product during type testing and provide data to owner and class society	

14	Other vessel Operations
Other vessel Operations	

No.: 14		Other vessel Operations								
Item	Deviation	Causes	Consequences	Matrix	Severity	Likelihood	Risk	Safeguards	Recommendations	Comment
14.1	Cargo Operations at port	1. Dropped object (linked from 3.1)	1. Cargo pool fire	Asset	3	C	High	1. Foam system 2. Cargo pump room has fire detection 3. Deck watch continuously monitoring cargo transfer area for fire and other risk	94. Detail gas dispersion, fire/explosion analysis, radian heat load is to be conducted considering various discharge rates and fire situation to vent mast (HP and LP) or local discharge  95. Detail emergency procedure are to be developed for fire and other emergency situation	
			2. Radiant heat impacting CCPV tank	Asset	3	C	High			
			3. Fire impacting H <sub>2</sub> piping	Overall	S3-Moderate	LC-Possible	High			
		2. cargo leakage	1. Cargo pool fire	Asset	3	C	High	1. Foam system 2. Cargo pump room has fire detection 3. Deck watch continuously monitoring cargo transfer area for fire and other risk	94. Detail gas dispersion, fire/explosion analysis, radian heat load is to be conducted considering various discharge rates and fire situation to vent mast (HP and LP) or local discharge  95. Detail emergency procedure are to be developed for fire and other emergency situation  96. Emergency plan are to be developed with port authority	

No.: 14		Other vessel Operations								
Item	Deviation	Causes	Consequences	Matrix	Severity	Likelihood	Risk	Safeguards	Recommendations	Comment
			2. Radiant heat impacting CCPV tank	Asset	3	C	High			
			3. Fire impacting H <sub>2</sub> piping	Overall	S3-Moderate	LC-Possible	High			
		3. Electrical fire in pump room	2. Radiant heat impacting CCPV tank	Asset	3	C	High	1. Foam system 2. Cargo pump room has fire detection 3. Deck watch continuously monitoring cargo transfer area for fire and other risk	94. Detail gas dispersion, fire/explosion analysis, radian heat load is to be conducted considering various discharge rates and fire situation to vent mast (HP and LP) or local discharge 95. Detail emergency procedure are to be developed for fire and other emergency situation 96. Emergency plan are to be developed with port authority	
			3. Fire impacting H <sub>2</sub> piping	Overall	S3-Moderate	LC-Possible	High			
14.2	Cargo lightening at sea								97. Considering H <sub>2</sub> proximity for other ship and they are not design for H <sub>2</sub> exposure further study are to be conducted to identify risk and appropriate mitigation	

15	Testing, Maintenance & Inspection
Testing, Maintenance & Inspection	

No.: 15		Testing, Maintenance & Inspection								
Item	Deviation	Causes	Consequences	Matrix	Severity	Likelihood	Risk	Safeguards	Recommendations	Comment
15.1	New								98. Detail maintenance procedure and training re to be developed for ship H <sub>2</sub> system 101. Qualified people availability for H <sub>2</sub> fabrication/welding etc. can be challenging and need to be consider in overall project risk 102. Hydrogen material issue? 103. H <sub>2</sub> has reverse JT and crew need to be aware of it 104. Suitable H <sub>2</sub> detection method for marine use are to be developed	

## Appendix XII – List of Recommendations CH4 to H2 Technology

No.	Action	References	Status	Comment
1	Sweetening Absorber change out, maintenance philosophy, and materials are to be developed.	1.1 Impurity in incoming gas – TCD System - Feed gas, Gas Sweetening, Feed Gas Preheater	In Progress	Accepted.  Sweetening Absorber change out, maintenance philosophy, and materials will be developed in advance during application phase. Other information: Feed gas sweetening unit is based on layer of porous filtering granules made on Zinc Oxides (ZnO). The feed gas will flow through the bed of granules and sulphur components are adsorbed from the gas stream. A typical feed gas onboard (vapourised LNG) contains very small amount of H <sub>2</sub> S and therefore the lifetime of adsorbent material is long (up to 1-2 years). Two sweetening units are normally operated in series. The adsorbent has colour change indicator to alert when it is time for replacement of first lead unit. In parallel, the adsorbents will have predefined change out schedule to ensure that units are kept in good working condition. When a change is required, a single unit is opened, the used adsorbent is removed from cartridge and new adsorbent materials is put in. Finally, cartridge is put back into sweetening unit housing.
2	Add high pressure monitoring and shutdown on incoming upstream feed gas stream (near TE-1002)	1.2 Availability of feed gas at correct temperature and pressure – TCD System - Feed gas, Gas Sweetening, Feed Gas Preheater	Resolved	RESOLVED, refer to PID-AIP-2202-05-18 revD update on PI-1010
3	Provide interlock and LL shutdown at PT-1010 to close inlet valve after sequence.	1.2 Availability of feed gas at correct temperature and pressure – TCD System - Feed gas, Gas Sweetening, Feed Gas Preheater 1.3 flow rate of incoming gas – TCD System - Feed gas, Gas Sweetening, Feed Gas Preheater	Resolved	RESOLVED, refer to PID-AIP-2202-05-18 revD update on PI-1010
4	Any Reactor tubes which see direct radiation heat from the burner are to be monitor or analysed to see what is the temperature on the outside surface of the tubes.	1.2 Availability of feed gas at correct temperature and pressure – TCD System - Feed gas, Gas Sweetening, Feed Gas Preheater 1.3 Flow rate of incoming gas – TCD System - Feed gas, Gas Sweetening, Feed Gas Preheater 2.2 Combustion temperature inside Reactor – TCD System - Feed Gas Decomposition Reactor	In Progress	
5	Add HH temperature shutdown to temperature indicator TI-1002 at the decomposition gas outlet of Reactor.	1.2 Availability of feed gas at correct temperature and pressure – TCD System - Feed gas, Gas Sweetening, Feed Gas Preheater 1.3 Flow rate of incoming gas – TCD System - Feed gas, Gas Sweetening, Feed Gas Preheater	Resolved	RESOLVED, refer to PID-AIP-2202-05-18 revD update on TI-1002A&B



No.	Action	References	Status	Comment
		2.2 Combustion temperature inside Reactor – TCD System - Feed Gas Decomposition Reactor 2.3 Catalyst level inside Reactor – TCD System - Feed Gas Decomposition Reactor		
6	Interface and communication protocol between FGSS and Rotoboost system is to be established in detailed engineering phase for proper monitoring and shutdown.	1.3 Flow rate of incoming gas – TCD System - Feed gas, Gas Sweetening, Feed Gas Preheater 22.1 Predetermined shutdown of FGSS or engine – Vessel - Ship Operation/Simultaneous operation 22.2 Emergency or upset shutdown of FGSS or engine – Vessel - Ship Operation/Simultaneous operation	In Progress	
7	Conduct Gas Dispersion analysis and Fire & Explosion analysis to understand fire and explosion hazards. Provide appropriate mitigation measures for firefighting system.	1.4 Methane leakage – TCD System - Feed gas, Gas Sweetening, Feed Gas Preheater 8.1 Hydrogen leak – TCD System - Ventilation system 14.1 TCD system installation location on product carrier and VLCC – Vessel - General Arrangement	In Progress	Gas dispersion analysis has been conducted under 30 ACH incoming flow rate inside the TCD system, in our leak analysis we considered a 4mm crack in the decomposition tube outlet, the flow rate of the crack was considered to be 0.0108 kg/s based on the 17 bara operating pressure and a pressure drop due to the leak to 1.2 bara.  In conclusion the results showed that the volume fraction of H <sub>2</sub> is below than 0.33 % of the total volume of the air in the TCD system, which is below the LEL of H <sub>2</sub> of 4 %. The dispersion also indicates that the Hydrogen gas will flow upwards and towards the outlet duct due to the low pressure applied by the outlet fans.
8	During fabrication and installation, proper cleaning procedures are to be developed to remove any debris from piping, to minimise plugging in the system.	1.5 Sweetening Absorber is 100% saturated – TCD System - Feed gas, Gas Sweetening, Feed Gas Preheater	In Progress	
9	Explosion damage to be evaluated to understand explosion impact on container, equipment and Reactor.	2.1 Explosion inside Reactor – TCD System - Feed Gas Decomposition Reactor	Resolved	The explosion inside the reactor was evaluated for hydrogen gas leak with a volume of the total reactor (~30 % of the total volume of the container). The pressure of a hydrogen explosion at 30 % mixture is about 1.5 MPa pressure and the explosion velocity is 2000 m/s, the results showed that the reactor with material SS 304 took most of the damage but was not breached, while the container with material carbon steel did not sustain any damage.  These results were also compared to COMP B explosion (High explosive material-RTX, TNT- Composition) with 29.5 GPa pressure and 7980 m/s explosion velocity, the results showed that the integrity of the container is compromised with 100 mm deformation but it was not breached and the reactor was totally destroyed. In conclusion, our reactor and container will be able to contain a hydrogen or hydrocarbon explosion due to the thickness and material strength used.

No.	Action	References	Status	Comment
10	Conduct study for where the explosion gases will go from pressure relief panel from TCD container top to relieve pressure from container.	2.1 Explosion inside Reactor – TCD System - Feed Gas Decomposition Reactor 14.9 TCD space inside fuel room of ferry – Vessel - General Arrangement	In Progress	Ship specific kayout arrangement will be evaluated during project execution stage.
11	Catalyst solids and salts are stored in feeding units, close to the Decomposition Gas Buffer Tank. Location to be studied with respect to installed vessel and its requirements.	2.3 Catalyst level inside Reactor – TCD System - Feed Gas Decomposition Reactor	In Progress	Each vessel may have unique optimal location for this equipment. The catalyst solids and salts are types of material which is quite easy to convey via closed pipe also from little further away into molten salt tank, where they are dosed. Therefore, the design allow flexibility to find most suitable location also considering catalyst & salt storage arrangement onboard.
12	Further studies are to be done and further applications to be provided to minimise low level in Reactor.	2.3 Catalyst level inside Reactor – TCD System - Feed Gas Decomposition Reactor	In Progress	Accepted. Catalyst level will be measured by suitable Liquid Level Indicator. Several reactor tubes will be equipped with redundant level indicators to mitigate measurement error. And will keep pumping more than required molten liquid from molten salt tank so that salt level in reactor can be maintained by overflow.
13	Further studies to be done to determine ratio of salt and catalyst, and level monitoring of catalyst and salt in Reactor tubes.	2.3 Catalyst level inside Reactor – TCD System - Feed Gas Decomposition Reactor	In Progress	
14	Add LL shutdown to OIC-1001 oxygen analyzer shutdown, interlock with Burner Management system.	2.6 Combustion air flow or gas flow to Reactor – TCD System - Feed Gas Decomposition Reactor	Resolved	RESOLVED, refer to PID-AIP-2202-05-18 revD update on OIC-1001.
15	Add H alarm and HH shutdown and appropriate setpoints to LEL-1001 flammable gas detector in exhaust gas outlet of Reactor.	2.6 Combustion air flow or gas flow to Reactor – TCD System - Feed Gas Decomposition Reactor 11.1 Maintenance activities – TCD System - Maintenance Operations	Resolved	RESOLVED, refer to PID-AIP-2202-05-18 revD update on AE-1001.
16	Installation specific requirements to be followed per regulations and class society rules.	2.6 combustion air flow or gas flow to Reactor – TCD System - Feed Gas Decomposition Reactor 2.7 exhaust gas Venting – TCD System - Feed Gas Decomposition Reactor	In Progress	
17	Investigate if there is any possibility of condensation inside the container (due to low temperature) and provide proper insulation or drip trays.	2.8 Temperature inside container – TCD System - Feed Gas Decomposition Reactor	In Progress	For any possibility of condensation inside the container (due to low temperature), proper insulation or drip trays will be provided during engineering phase.

No.	Action	References	Status	Comment
18	Conduct heat calculations and ventilation studies to determine optimal air flow capacity and insulation need to maintain the inside temperature of TCD container.	2.8 Temperature inside container – TCD System - Feed Gas Decomposition Reactor	In Progress	<p>Heat calculations were conducted considering 35 Co as our outside ambient temperature and 38 Co were considered for the surface temperatures of the container walls having 10 mm thickness. The reactor surface temperature was considered at 150 Co (Note for conservative reasons we are using 150 Co as the surface temperature but in our application the temperature will be much lower with proper insulation) and the reactor was lifted 100 mm above the bottom wall, all equipment inside the container were included in the heat calculations depending on their surface temperature or heat load. The inlet duct is located 12200 mm away from the reactor and the outlet duct was 750mm away from the tangent of the reactor on the ceiling, 45 ACH were selected and compared to 30 ACH for the TCD system. The results showed that the temperature inside TCD system will be around 42 Co -45 Co in the majority regions of the container with highest temperature in proximity to the reactor's surface at 82 Co using 45 ACH. However, for the 30 ACH the reactor surface temperature was higher and the overall temperature inside the reactor was a couple of degrees higher. In the case of cooler ambient temperature, assuming that the TCD system is operating in cooler weather, the temperature inside the system will be below 42 Co.</p> <p>In conclusion, the ambient temperature inside the container will not be greater than 45 Co for the majority of the working area sections and for the limited high temperature zone in proximity to the reactor's surface, we will implement additional safety measures to prevent potential influence or injury to the TCD system operators when he/she incidentally touch the limited high temperature zone. In addition, we will adjust the simulation once the final insulation material is fixed and lower operation temperature value than the above data is possible to be achieved, will revert to ABS at that time.</p>
19	From Human Ergonomic and human comfort perspective, provide suitable PPE and develop proper inspection and maintenance procedures to minimise personnel exposure to heat inside container.	2.8 Temperature inside container – TCD System - Feed Gas Decomposition Reactor 23.1 Personnel working inside TCD system container (product carrier or VLCC) – Vessel - Emergency Escape, Evacuation, and Rescue (EER) 23.2 Personnel working inside TCD space inside fuel room (ferry) – Vessel - Emergency Escape, Evacuation, and Rescue (EER)	In Progress	

No.	Action	References	Status	Comment
20	Proper maintenance and inspection procedures are to be developed for the system and equipment.	2.9 Leakage of exhaust gas inside container (Review Section 1) – TCD System - Feed Gas Decomposition Reactor 3.5 exhaust gas Piping breakage – TCD System - Molten Salt Separator (012V01) and Molten Salt Collection Tank (012V02)	In Progress	
21	Conduct detailed thermal analysis study to determine if material can stay in liquid form or can be solidified, leading to piping damage.	2.10 Solidification – TCD System - Feed Gas Decomposition Reactor	In Progress	<p>Detailed thermal analysis was conducted and also research was conducted to the solidification point of the molten liquid. The results showed that the initial solidification will begin when the reactor temperature is at the melting temperature of the catalyst used in the process. Furthermore, since we have two different mediums (salt +catalyst) used in the system we will have two different solidification temperatures, for our system the temperature will be kept above the melting temperatures of both mediums depending on the variety of catalysts that will be used in the system.</p> <p>Incase solidification occurs in the system, the salt will shrink as its density will become higher in its crystal structure form. Similarly, the metal catalyst will shrink as its density becomes higher in solid form. We will conduct a stress analysis to the piping, where we will consider the pressure of the system, the hoop stress applied by the salt expansion and the thermal stress on the piping. In Addition, it should be noted that in all circumstances the piping downstream and upstream will be free for the salt to expand and it is highly unlikely that both ends will be blocked fully at a given time during the process.</p>
22	Study issues of solidifications on pump discharge piping and provide appropriate solutions.	2.10 Solidification – TCD System - Feed Gas Decomposition Reactor	In Progress	<p>Research has been done, till now the result is positive: Molten salt recycle pump discharge line is designed with no check valve, molten salt could gravity drain to collection tank when pump stop, has been confirmed by Pump vendor, so residual liquid on pump discharge piping is very limited after pump stop. Exhaust gas heat tracing will be added on molten salt recycle pump discharge line.</p>

No.	Action	References	Status	Comment
23	Study the block discharge load on O12P01 Molten Salt Recycle Pump and include in VFD shutdown philosophy.	2.10 Solidification – TCD System - Feed Gas Decomposition Reactor		<p>Pump VFD will have overload alarm and low current alarm to detect any abnormal situation and later trigger interlock. Pump can gradually ramp up when start, which have been confirmed by Vendor.</p> <p>The maximum back pressure that the pump can deliver is about 13 bar and since the pump that will be used is a centrifugal pump the pressure downstream will not be beyond the design pressure of the pump and therefore, it will not damage the pump.</p> <p>The centrifugal pump also is equipped with a VFD system and it has a low current alarm which will trigger an interlock in case the downstream flow is obstructed.</p> <p>Once the pump is shutdown the liquid inside the pump discharge line will flow back by gravity to the liquid salt tank.</p>
24	Consider providing pressure monitoring at the discharge of O12P01 Molten Salt Recycle Pump.	2.10 Solidification – TCD System - Feed Gas Decomposition Reactor	Resolved	RESOLVED, refer to PID-AIP-2202-05-18 revD update on PI-1005.
25	System has to provide some form of detection to detect solidification or partial blockage inside discharge piping from Reactor to Molten Salt Separator.	2.10 Solidification – TCD System - Feed Gas Decomposition Reactor	Resolved	RESOLVED, refer to PID-AIP-2202-05-18 revD update on PI-1006, PDC-1006, and PT-1002.
26	Study the need for draining the Reactor and Molten Salt Collection Tank (O12V02) and other equipment or piping where solidification is a possibility due to leakage, other emergencies or regular maintenance. Consider maintenance to be done in a marine environment.	2.10 Solidification – TCD System - Feed Gas Decomposition Reactor 3.7 Inability to drain Molten Salt Collection Tank (O12V02) – TCD System - Molten Salt Separator (O12V01) and Molten Salt Collection Tank (O12V02)	Resolved	RESOLVED, refer to PID-AIP-2202-05-18 revD update. Added a Ceramic Plug inside drain nozzle blind flange, and Ceramic Plug drawing is shown on Note 3, sheet 3.
27	Thermal expansion characteristics are to be developed for Reactor tubing, catalyst, and salt.	2.10 Solidification – TCD System - Feed Gas Decomposition Reactor	In Progress	
28	Consider discharge piping with enough slope to Molten Salt Separator (O12V01)	2.10 Solidification – TCD System - Feed Gas Decomposition Reactor	Resolved	RESOLVED, refer to PID-AIP-2202-05-18 revD update. Slope is added to the design.
29	Quantity and storage need for nitrogen are to be evaluated and purity of nitrogen to be specified considering impact on the system.	2.11 Nitrogen (N <sub>2</sub> ) purge cycle – TCD System - Feed Gas Decomposition Reactor	In Progress	
30	Study the potential for carbon accumulation in low points in the system piping (downstream of Reactor) in detailed engineering phase.	2.12 Decomposition gas and carbon in the system from Reactor outlet to Carbon Filters – TCD System - Feed Gas Decomposition Reactor	In Progress	
31	Study the suitability of system instrumentations for the decomposition gas stream systems up to Carbon Filters. Potential carbon accumulation and operating in carbon rich environment may lead to decreased accuracy/availability of system instrumentation.	2.12 Decomposition gas and carbon in the system from Reactor outlet to Carbon Filters – TCD System - Feed Gas Decomposition Reactor	In Progress	

No.	Action	References	Status	Comment
32	Investigate possibility of blockage and develop philosophy for monitoring decomposition gas system to detect blockage.	3.1 Filter inside Molten Salt Separator (012V01) – TCD System - Molten Salt Separator (012V01) and Molten Salt Collection Tank (012V02)		
33	Develop philosophy to cleaning the filter inside Molten Salt Separator (012V01)	3.1 Filter inside Molten Salt Separator (012V01) – TCD System - Molten Salt Separator (012V01) and Molten Salt Collection Tank (012V02)	In Progress	
34	Detection for filter breakthrough and any accumulation of carbons inside 012V02 Molten Salt Collection Tank are to be addressed from safety and operation perspective.	3.4 Filter breakthrough inside Molten Salt Separator (012V01) – TCD System - Molten Salt Separator (012V01) and Molten Salt Collection Tank (012V02)	Resolved	RESOLVED, refer to PID-AIP-2202-05-18 revD update. 012V02 Molten Salt Collection Tank now includes level deviation control.
35	Consider providing additional instrumentation for detection of gas leakage due to tubes failure, pinhole or large leaks at 012V01 Molten Salt Separator, 012V02 Molten Salt Collection Tank, 012E03 Feed Gas Final Preheater (e.g., hydrogen and hydrocarbon detection)	3.5 Exhaust gas Piping breakage – TCD System - Molten Salt Separator (012V01) and Molten Salt Collection Tank (012V02) 4.1 Exhaust gas pressure and temperature – TCD System - Feed Gas Final Preheater 11.1 Maintenance activities – TCD System - Maintenance Operations	Resolved	RESOLVED, refer to PID-AIP-2202-05-18 revD update. Add sight glass at low point of exhaust gas circuit with level switch LSHH 1003 for leakage detection and interlock. Add flammable gas detector AE-2001 and temperature transmitter AE-2006 in exhaust gas pipe.
36	All equipment in the system may have solidification issues. RAM study is to be conducted to address solidification issues.	3.6 Solidification inside Molten Salt Collection Tank (012V02) – TCD System - Molten Salt Separator (012V01) and Molten Salt Collection Tank (012V02)	In Progress	
37	Add level L alarm to LT-1201 and LL interlock to monitor low level in 012V02 Collection Tank. Current design only has H and HH.	3.8 Level inside Molten Salt Collection Tank (012V02) – TCD System - Molten Salt Separator (012V01) and Molten Salt Collection Tank (012V02)	Resolved	RESOLVED, refer to PID-AIP-2202-05-18 revD update on LIC-1201, with L alarm and LL shutdown.
38	Investigate possibility of molten salt and catalysts carryover from Molten Salt Collection Tank (012V02) to vent line with PV-1205 and HV-1210. Consequences are to be evaluated as they can lead to blockage of vent lines.	3.8 Level inside Molten Salt Collection Tank (012V02) – TCD System - Molten Salt Separator (012V01) and Molten Salt Collection Tank (012V02)	In Progress	
39	Rotoboost to further study the monitoring of quantity of catalyst and salt inside the Reactor and develop monitoring and control measures to manage appropriate salt and catalyst quantity inside the Reactor.	3.11 Catalyst and Salt mixture in Molten Salt Collection Tank (012V02) – TCD System - Molten Salt Separator (012V01) and Molten Salt Collection Tank (012V02)	In Progress	
40	From operational experience, data need to be collected on rate of catalyst loss to optimise the quantity and feed rate of catalyst and salt to Reactor	3.11 Catalyst and Salt mixture in Molten Salt Collection Tank (012V02) – TCD System - Molten Salt Separator (012V01) and Molten Salt Collection Tank (012V02)	In Progress	
41	Investigate any weight measurement of Reactor tubes can help determine the quantity of catalyst and salt in the system	3.11 Catalyst and Salt mixture in Molten Salt Collection Tank (012V02) – TCD System - Molten Salt Separator (012V01) and Molten Salt Collection Tank (012V02)	In Progress	
42	Consider adding another independent layer of protection temperature monitor (independent from TE-1005 at Reactor exhaust gas outlet) to monitor temperature in Exhaust Gas stream.	4.1 Exhaust gas pressure and temperature – TCD System - Feed Gas Final Preheater	Resolved	RESOLVED, refer to PID-AIP-2202-05-18 revD update on TI-2006.

No.	Action	References	Status	Comment
43	Review gas separation system and provide solution to prevent gas blowby to Carbon Conveyor 020P01. Evaluate ability to push carbon to Carbon Conveyor 020P01 and evaluate use of N <sub>2</sub> to push carbon.	5.1 Gas blowby – TCD System - Carbon and Decomposition Gas Separation	Resolved	RESOLVED, refer to PID-AIP-2202-05-18 revD update PIC-2007 (N <sub>2</sub> injection pressure control loop)
44	Consider adding low level alarm and shutdown at 020V03 Carbon Buffer Vessel to prevent gas blowby to the Carbon Conveyor 020P01.	5.1 Gas blowby – TCD System - Carbon and Decomposition Gas Separation	Resolved	RESOLVED, refer to PID-AIP-2202-05-18 revD update. Add level switch LSL 2004 on 020V03, when detect no level, will trigger an interlock to shutdown bottom valve HV2017
45	Review hydrogen/carbon separation system ability to push carbon from 20E01 Feed Gas Preheater and 020F01A/B Carbon Filters to 020V03 Carbon Buffer Vessel.	5.1 Gas blowby – TCD System - Carbon and Decomposition Gas Separation	In Progress	Carbon will go to 020V03 Carbon Buffer Vessel by gravity, pressure difference and also gas purge. Will further develop the blowdown sequence during detail engineering.

No.	Action	References	Status	Comment
46	Detailed maintenance procedures, material storage and handling procedures, and disposal guidelines inside the container are to be developed.	<p>6.3 Drainage and disposal from container – TCD System - GA inside Container</p> <p>11.1 Maintenance activities – TCD System - Maintenance Operations</p> <p>14.3 Catalyst and salt storage (for VLCC, product carrier, and ferry) – Vessel - General Arrangement</p>		<p>Standard and safety procedures will be applied when collection and disposal materials, the methods are briefly described in the following guidelines:</p> <ol style="list-style-type: none"> <li>1- This material inside the container must be disposed of in a safe way.</li> <li>2- Ensure adequate ventilation</li> <li>3- Care should be taken when handling disposal from the containers and standard operation procedures should be followed.</li> <li>4- Avoid dispersal of spilled material and contact with sea water.</li> <li>5- Empty containers should be taken to an approved waste handling site for recycling or disposal</li> <li>6- Ensure trained personnel present are present to conduct the disposal,</li> <li>7- Ensure proper safety equipment is available, for example: Duty gloves; Face mask or full-face piece respirator depending on the case. Chemical resistant clothing. In addition, the chemicals, glassware and other equipment needed for treatment in preparation for disposal should be available.</li> </ol> <p>Guidelines for storage of materials and catalysts:</p> <ol style="list-style-type: none"> <li>1- Catalyst should be stored in a dry place,</li> <li>2- The catalyst should be kept sealed to avoid contamination to the environment.</li> <li>3- All catalysts packaging shall be appropriately labelled with an appropriate warning statement, such as: <ul style="list-style-type: none"> <li>- CAUTION</li> <li>- Spent catalyst</li> <li>- Avoid Breathing Dust or Contact with skin.</li> </ul> </li> <li>4- Catalyst packaging should be inspected to check whether there is damaging or not when they arrive on site.</li> <li>5- Catalyst packaging should not be opened until they will be loaded into the desired vessel.</li> <li>6- Care should be taken to avoid accidental damage to packaging during storage or transportation.</li> <li>7- Catalysts packaging should be stored away from other easily flammable materials,</li> <li>8- Catalysts packaging should always be protected from mechanical impact, crushing and water or moisture (kept dry).</li> <li>9- In case of fire dry powder firefighting system should be installed.</li> <li>10- Confined space conditions shall be monitored continuously.</li> </ol>



No.	Action	References	Status	Comment
47	Further study to verify catalyst life and mechanisms for degradation of catalyst and salt.	6.3 Drainage and disposal from container – TCD System - GA inside Container	In Progress	The performance of the catalyst will be monitored by the continuous analysis yield of the decomposition gas. Also, we can conduct analysis for some samples of the catalyst to verify the status of the catalyst.
48	Venting of exhaust gas are to be decided based on installation specific requirements.	7.2 Exhaust gas venting (see sections 20.1 and 20.2) – TCD System - Venting System	In Progress	
49	Provide water spray system on outside surface to keep container cool.	8.1 Hydrogen leak – TCD System - Ventilation system	Resolved	RESOLVED, refer to PID-AIP-2202-05-18 revD update. Added water spray system to container outside surface.
50	Upon detection of hazard, interlink between FGSS and TCD container system has to be determined.	8.1 Hydrogen leak – TCD System - Ventilation system	Resolved	RESOLVED, refer to PID-AIP-2202-05-18 revD update. Added detections to container and hazard alarm interlink to FGSS.
51	For hydrocarbon and methane gas leak, air inlet to the container has to be from a safe area and outlet has to be located appropriately for installation specific requirements.	8.1 Hydrogen leak – TCD System - Ventilation system		<p>Gas dispersion analysis has been conducted under 30 ACH incoming flow rate inside the TCD system, in our leak analysis we considered a 4mm crack in the decomposition tube outlet, the flow rate of the crack was considered to be 0.0108 kg/s based on the 17 bara operating pressure and a pressure drop due to the leak to 1.2 bara.</p> <p>In conclusion the results showed that the volume fraction of H<sub>2</sub> is below than 0.33 % of the total volume of the air in the TCD system, which is below the LEL of H<sub>2</sub> of 4 %. The dispersion also indicates that the Hydrogen gas will flow upwards and towards the outlet duct due to the low pressure applied by the outlet fans.</p>
52	Consider providing toxic gas detection inside the container to detect any leakage from exhaust gas stream.	8.3 Exhaust gas leak – TCD System - Ventilation system	Resolved	RESOLVED, refer to PID-AIP-2202-05-18 revD update. Flammable gas detector can also detect CO. Added flammable gas detectors: AE-0001, 0002 inside container, and AE-0003 at ventilation outlet.

No.	Action	References	Status	Comment
53	Proper materials handling and disposal procedures are to be developed for catalysts and salt.	9.1 Catalysts disposal – TCD System - Chemicals		Guidelines for disposal of catalyst and salts: 1- Collect and dispose catalysts and salts in sealed containers at licensed waste disposal site. 2- Dispose of contents/container in accordance with local /national/international regulations. 3- Disposal must be in accordance with current applicable laws and regulations, and material characteristics at time of disposal. 4- This material inside the container must be disposed of in a safe way. 5- Care should be taken when handling taking disposal from the containers and standard operation procedures should be followed. 6- Avoid dispersal of spilled material and contact with sea water. 7- Empty containers should be taken to an approved waste handling site for recycling or disposal 8- Ensure trained personnel present are present to conduct the disposal, 9- Ensure proper safety equipment is available, for example: - Duty gloves; - Face mask or full-face piece respirator depending on the case, - Chemical resistant clothing. In addition, the chemicals, glassware and other equipment needed for treatment in preparation for disposal should be available.
54	Develop firefighting procedures with consideration for bismuths in catalyst.	9.1 Catalysts disposal – TCD System - Chemicals	In Progress	
55	Proper PPE are to be provided to safely handle catalysts and salts.	9.1 Catalysts disposal – TCD System - Chemicals	In Progress	Accepted and will follow during engineering phase. Part of response also refer to the Response No. 47 in Document of Res-AIP2202-14-01
56	Conduct detailed RAM study at a later detailed engineering stage and incorporate results in the maintenance procedures.	11.1 Maintenance activities – TCD System - Maintenance Operations	In Progress	
57	Develop detailed inspection procedures for the lifetime of the system, including appropriate replacement schedule for equipment (i.e., annually)	11.1 Maintenance activities – TCD System - Maintenance Operations	In Progress	
58	System has to be designed such that it can detect salt or catalyst leakage to exhaust gas circuit of the system	11.1 Maintenance activities – TCD System - Maintenance Operations	Resolved	RESOLVED, refer to PID-AIP-2202-05-18 revD update. Added sight glass at low point of exhaust gas circuit with level switch LSHH 1003 for leakage detection and interlock.
59	Study proper materials and design selection of tubes in the Reactor, with consideration for Reactor operating in hydrogen rich environment at high temperature and direct flame exposure.	11.1 Maintenance activities – TCD System - Maintenance Operations	In Progress	
60	Study the potential catalyst (bismuth) exposure to oxygen during maintenance activities and develop proper procedures to minimise the risk.	11.1 Maintenance activities – TCD System - Maintenance Operations	In Progress	

No.	Action	References	Status	Comment
61	Detailed study are to be developed for the product carrier, and dispersion analysis to be conducted to see if exhaust ventilation and LNG/H <sub>2</sub> /product ventilation are not interfering to create explosion and fire hazards.	14.1 TCD system installation location on product carrier and VLCC – Vessel - General Arrangement	In Progress	
62	Determine the type of insulation/cladding and effectiveness for exhaust vent piping to manage surface temperature below auto-ignition temperature and stay in tack (not breaking apart).	14.1 TCD system installation location on product carrier and VLCC – Vessel - General Arrangement	In Progress	
63	Consider the cargo piping routes and study the risks due to installation of TCD system container to find a safe space to install the TCD system	14.1 TCD system installation location on product carrier and VLCC – Vessel - General Arrangement	In Progress	
64	Keep TCD vent mast separate and as far as possible from other vent masts.	14.1 TCD system installation location on product carrier and VLCC – Vessel - General Arrangement	In Progress	
65	Investigate if TCD system has to shut down during cargo loading/unloading operation. Also consider the port operations restrictions and owner operation procedures.	14.1 TCD system installation location on product carrier and VLCC – Vessel - General Arrangement	In Progress	<p>Defer to Detailed Engineering Phase.</p> <p>TCD system cannot operate normally if FGSS is not operational. Depending on location of TCD system, the operation may be forbidden by rules during cargo operations as extended safety precaution.</p> <p>Three possible basic alternatives for TCD system are;</p> <ol style="list-style-type: none"> <li>1) include fuel gas buffer tank in reactor heating burner fuel line to be able to operate heating burner in XX hours (to be defined during detailed design) at minimal load during FGSS shutdown/bunkering period/etc.,</li> <li>2) include alternative fuel supply system for heating burner to be able to operate it at minimal load during FGSS shutdown/bunkering period/etc.,</li> <li>3) shut down also TCD system as per defined procedure. Heat insulation will keep TCD reactor hot for long time. The longer the shutdown period is, the longer time is needed for system restart.</li> </ol> <p>Alternative 1 may be prevented by TCD system location, e.g., on tank top above cargo tanks. Alternative 3 is always possible regardless of alternatives 1+2.</p> <p>Final solution can be selected in project execution phase considering vessel type, class rules, operating profile, and Owner preference. Rotoboost consider alternative 3 to be safest and simplest till now, we will decide final solution in latter phase.</p>
66	If ship owner and regulations do not allow LNG in the port, consider adding another fuel (diesel) to run TCD system during port operations.	14.1 TCD system installation location on product carrier and VLCC – Vessel - General Arrangement	In Progress	Defer to Detailed Engineering Phase.

No.	Action	References	Status	Comment
67	Consider proper insulation, cladding for the exhaust piping to minimise the temperature to below the auto-ignition temperature of hydrocarbon or other products.	14.1 TCD system installation location on product carrier and VLCC – Vessel - General Arrangement 20.5 Vent mass arrangement for exhaust gas venting (product carrier and VLCC) – Vessel - Ventilation and Venting System	In Progress	
68	Vent stack for H <sub>2</sub> to be designed to withstand pressure higher than 25 bar (in case of detonation, the maximum pressure generated is 25 bar)	14.1 TCD system installation location on product carrier and VLCC – Vessel - General Arrangement	Resolved	RESOLVED, refer to PID-AIP-2202-05-18 revD update.
69	Further studies are to be done to check regulation restrictions for putting fire equipment on the deck with respect to SOLAS and IGF.	14.1 TCD system installation location on product carrier and VLCC – Vessel - General Arrangement	In Progress	
70	Consider installing equipment inside a separate room with proper relief hatch venting to the upper deck of the ferry. If there is more than two TCD systems, install them in the same space.	14.2 TCD system installation location on ferry – Vessel - General Arrangement 14.9 TCD space inside fuel room of ferry – Vessel - General Arrangement 21.2 Active firefighting (for ferry) – Vessel - Safety Systems (F&G Detection, Active & Passive Firefighting, etc.)	In Progress	
71	Conduct fire & explosion and gas dispersion studies for TCD space and fuel space to ensure that damage is limited inside the TCD space and/or room and overpressure is properly relieved.	14.2 TCD system installation location on ferry – Vessel - General Arrangement 14.9 TCD space inside fuel room of ferry – Vessel - General Arrangement 18.1 Leakage of H <sub>2</sub> and CH <sub>4</sub> mixture – Vessel - Engine Room Arrangement/ Fuel supply from FGSS/TCD to Engine room 21.2 Active firefighting (for ferry) – Vessel - Safety Systems (F&G Detection, Active & Passive Firefighting, etc.)	In Progress	Gas dispersion analysis has been conducted and it was observed that the gas leak will circulate within the container system before it leaves through the outlet duct with the highest concentration of hydrogen accumulating at the top section of the outlet duct. The F&G detector mapping was set according to the leak dispersion. According to the analysis the LEL of hydrogen will not be reached with 45 ACH. A separate analysis for the explosion was conducted and the container space is able to withstand a hydrogen explosion without breaching the engine room.  We will conduct a dispersion analysis, explosion analysis and F&G detector mapping analysis for H <sub>2</sub> concept in marine environment, including in engine room, during real application case.
72	Proper study has to be conducted considering surrounding space and equipment inside the space, to comply with SOLAS and other regulation requirements.	14.2 TCD system installation location on ferry – Vessel - General Arrangement 14.9 TCD space inside fuel room of ferry – Vessel - General Arrangement	In Progress	

No.	Action	References	Status	Comment
73	Detailed CFD analysis and ventilation study are to be conducted to manage the temperature within the acceptable limit, considering the electrical equipment rating and human perspective.	14.2 TCD system installation location on ferry – Vessel - General Arrangement 14.9 TCD space inside fuel room of ferry – Vessel - General Arrangement	In Progress	The average temperature within the container was 42 C0- 45 C0 (considering the assumption that reactor surface temperature is 150 0C - to be lowered later with new insulation material) which is acceptable for electrical equipment and to human perspective. For the limited high temperature zone in proximity to the reactor's surface, we will implement additional safety measures to prevent potential influence or injury to the TCD system operators.
74	Consider separating TCD space from other vessel category A machinery space	14.2 TCD system installation location on ferry – Vessel - General Arrangement 14.9 TCD space inside fuel room of ferry – Vessel - General Arrangement	In Progress	
75	Any other products stored in the same space are to be looked at from hazards perspective and fire consequences	14.3 Catalyst and salt storage (for VLCC, product carrier, and ferry) – Vessel - General Arrangement	In Progress	
76	In case of fire involving bismuth, conduct study to find appropriate firefighting measures, e.g., water mist, foam, dry powder.	14.3 Catalyst and salt storage (for VLCC, product carrier, and ferry) – Vessel - General Arrangement	In Progress	
77	IGF code requires deluge and blowdown systems in case of fire.	14.4 Buffer tank on deck (for low pressure system on VLCC) – Vessel - General Arrangement	In Progress	
78	Since buffer tank will be a Type C tank, IGF code requires water spray system to keep the tank cool.	14.4 Buffer tank on deck (for low pressure system on VLCC) – Vessel - General Arrangement	Resolved	RESOLVED, refer to PID-AIP-2202-05-18 revD update. Added water spray for Type C tanks.
79	Since buffer tank will be a Type C tank, design needs to meet IGF code requirements.	14.4 Buffer tank on deck (for low pressure system on VLCC) – Vessel - General Arrangement	In Progress	
80	For VLCC, all cargo tank venting or any hazardous area vent on the weather deck, are to be studied with respect to location of TCD container, and maximum separations are to be provided due to high temperature equipment above the operating auto-ignition temperatures.	14.5 Fire equipment on deck (VLCC and product carrier) – Vessel - General Arrangement	In Progress	
81	Consider adding gas detector outside of container entrance door at appropriate locations to detect gas leak.	14.5 Fire equipment on deck (VLCC and product carrier) – Vessel - General Arrangement	Resolved	RESOLVED, refer to PID-AIP-2202-05-18 revD update. Add flammable gas detectors AE-0006 on the entrance door with note 8: Flammable gas LEL alarm on each door (sheet 7)
82	Consider installing gas detectors at the ventilation inlet to TCD system.	14.5 Fire equipment on deck (VLCC and product carrier) – Vessel - General Arrangement 20.3 Ventilation for TCD system (installation specific issues for product carrier and VLCC) – Vessel - Ventilation and Venting System	Resolved	RESOLVED, refer to PID-AIP-2202-05-18 revD update. Added flammable gas detectors AE-0004 & AE-0005 at the inlet of Ventilation system of TCD
83	Provide appropriate drip trays to collect carbon spillage on deck and develop proper disposal procedures.	14.6 Carbon storage in VLCC or product carrier (common issues) – Vessel - General Arrangement	In Progress	

No.	Action	References	Status	Comment
84	Investigate if water spray system is appropriate for carbon black handling to avoid dust formation. If water spray is used to prevent carbon dust, consider developing detailed procedures and system requirements.	14.6 Carbon storage in VLCC or product carrier (common issues) – Vessel - General Arrangement	In Progress	Based on current research it is necessary to use a water spray system to control humidity. Detailed procedures and system requirements to be developed.
85	IMDG cargo classifications and packaging requirements are to be studied for the carbon storage container.	14.6 Carbon storage in VLCC or product carrier (common issues) – Vessel - General Arrangement	In Progress	IMDG classification for carbon is Class 4.1 Flammable solids Product carbon, when dry, may ignite from external heat source above +350C, if oxygen is present. A simple solution to prevent/distinguish fire is by water mist spray onto carbon to keep its moist. Detail design to be developed
86	Investigate minimum salt % to keep carbon "wet" and appropriate salt type selection for carbon storage container.	14.6 Carbon storage in VLCC or product carrier (common issues) – Vessel - General Arrangement	In Progress	1- We estimate the current wetted portion could be around 10 %. 2- Will check the exact salt wetted portion in the coming up university testing and also in our lab testing 3- The selection of salt type is based on the following requirements: - Salt should be not easy to decompose to the reaction temperature (NaBr and KBr) have high melting temperature 747 °C and 734 °C respectively. - Salt should have less corrosion behavior - Salt should have intermediate density between carbon and catalyst, to allow carbon prevent carbon dis-attach metal catalyst.
87	Humidity need to be monitored continuously to prevent fire due to carbon black. Consider initiate water spray system to increase humidity.	14.6 Carbon storage in VLCC or product carrier (common issues) – Vessel - General Arrangement	In Progress	
88	Study external fire impact on carbon storage container and provide appropriate prevention and mitigation measures.	14.6 Carbon storage in VLCC or product carrier (common issues) – Vessel - General Arrangement	Resolved	An external fire was studied considering a radiation source of 1000 C0 and a natural convection effect of 1000 C0 air flow on the carbon storage container. The temperature inside the container was close to 970 C0 without any mitigation measures. However, after installing water sprays with suitable flow rate directly on the walls of the container with forced convection cooling, the temperature inside the container should be able to maintain the temperature much lower than the self-ignition temperature of carbon dust (350 C0).
89	Conduct further study and analysis on the carbon transfer system from the TCD system to the storage container or storage tank, considering impact due to ship motions, weather, etc. and impact of spillage.	14.6 Carbon storage in VLCC or product carrier (common issues) – Vessel - General Arrangement	In Progress	
90	When carbon storage is in VLCC void space surrounding engine room or accommodations, investigate the probability of explosion due to carbon dust and provide appropriate prevention and mitigation measures.	14.7 Carbon storage in VLCC or product carrier void space surrounding engine room (common issues) – Vessel - General Arrangement	In Progress	

No.	Action	References	Status	Comment
91	Study if void space is available in Ro-Pax vessel for TCD system.	14.7 Carbon storage in VLCC or product carrier void space surrounding engine room (common issues) – Vessel - General Arrangement	In Progress	
92	When carbon quantity is large, the carbon storage will be in a tank or inside a hull, which may impact vessel strength and stability. Vessel strength and stability has to be reevaluated to comply with vessel class rules.	14.7 Carbon storage in VLCC or product carrier void space surrounding engine room (common issues) – Vessel - General Arrangement	In Progress	
93	Conduct risk evaluations to prevent any fire or explosion inside the tank when carbon is stored inside the hull or in side tanks or oil tanks of a vessel.	14.7 Carbon storage in VLCC or product carrier void space surrounding engine room (common issues) – Vessel - General Arrangement	In Progress	
94	Conduct study on carbon production and storage on VLCC, or investigate partitioning of VLCC cargo void tank to make carbon storage possible for long voyage.	14.8 Carbon storage and general arrangements on VLCC (specific to VLCC) – Vessel - General Arrangement	In Progress	
95	Further design development are to be done to investigate how to collect carbon from individual TCD containers and stored in storage space.	14.8 Carbon storage and general arrangements on VLCC (specific to VLCC) – Vessel - General Arrangement	In Progress	
96	Conduct structural analysis with TCD and carbon containers on VLCC deck.	14.8 Carbon storage and general arrangements on VLCC (specific to VLCC) – Vessel - General Arrangement	In Progress	
97	Investigate gaps between TCD container and weather deck to avoid any confined space.	14.8 Carbon storage and general arrangements on VLCC (specific to VLCC) – Vessel - General Arrangement	In Progress	
98	Placement of TCD and carbon containers on VLCC are to be investigated.	14.8 Carbon storage and general arrangements on VLCC (specific to VLCC) – Vessel - General Arrangement	In Progress	
99	TCD equipment to be installed inside separate room by subdividing fuel space on ferry and provide separate explosion relief and ducting to safe space above weather deck.	14.9 TCD space inside fuel room of ferry – Vessel - General Arrangement	In Progress	
100	Investigate regulatory restrictions applicable to TCD system arrangements on ferry or investigate if coffer dam is required for engine and TCD space on ferry.	14.9 TCD space inside fuel room of ferry – Vessel - General Arrangement	In Progress	

No.	Action	References	Status	Comment
101	Conduct carbon explosion study to estimate the blast pressure and mitigation pressures are to be provided so structure can withstand blast load.	14.9 TCD space inside fuel room of ferry – Vessel - General Arrangement	In Progress	<p>The explosion inside the reactor was evaluated for hydrogen gas leak with a volume of the total reactor (~30 % of the total volume of the container). The pressure of a hydrogen explosion at 30 % mixture is about 1.5 MPa pressure and the explosion velocity is 2000 m/s, the results showed that the reactor with material SS 304 took most of the damage but was not breached, while the container with material carbon steel did not sustain any damage.</p> <p>These results were also compared to COMP B explosion (High explosive material-RTX, TNT- Composition) with 29.5 GPa pressure and 7980 m/s explosion velocity, the results showed that the integrity of the container is compromised with 100 mm deformation but it was not breached and the reactor was totally destroyed. In conclusion, our reactor and container will be able to contain a hydrogen or hydrocarbon explosion due to the thickness and material strength used.</p>
102	Consider double wall pipe for fuel space (not inside TCD container)	14.9 TCD space inside fuel room of ferry – Vessel - General Arrangement	In Progress	
103	EER study to be conducted for the TCD space	14.9 TCD space inside fuel room of ferry – Vessel - General Arrangement	In Progress	
104	Provide air locks for entry to TCD space and two means of escape routes or hatches from TCD space inside fuel room of ferry to vessel lifeboat.	14.9 TCD space inside fuel room of ferry – Vessel - General Arrangement 23.2 Personnel working inside TCD space inside fuel room (ferry) – Vessel - Emergency Escape, Evacuation, and Rescue (EER)	In Progress	
105	TCD space will require air inlet, ventilation outlet, and exhaust gas outlet, ducting placements and separation requirements are to be considered.	14.9 TCD space inside fuel room of ferry – Vessel - General Arrangement	In Progress	
106	Further study to be done on carbon storage, carbon conveying, and utilizing empty spaces.	14.9 TCD space inside fuel room of ferry – Vessel - General Arrangement	In Progress	
107	To remove carbon will require continuous entry into hazardous space and needs to be investigated further.	14.9 TCD space inside fuel room of ferry – Vessel - General Arrangement	In Progress	
108	Investigate if continuous carbon convey system is installed and what is the impact on hazardous zone extension.	14.9 TCD space inside fuel room of ferry – Vessel - General Arrangement	In Progress	
109	For hydrogen piping system, connection flange requirements are to be studied with respect to class and IGF codes.	15.2 Supply pressure to FGSS 2-stroke engine – Vessel - Fuel Gas Supply System (FGSS) for Engine and TCD	In Progress	
110	For HP compressor, venting system for compressor seals are to be designed per IGF and class requirements.	15.2 Supply pressure to FGSS 2-stroke engine – Vessel - Fuel Gas Supply System (FGSS) for Engine and TCD	In Progress	



No.	Action	References	Status	Comment
111	For LP system, determine appropriate compressor type and conduct vibration analysis for the entire system if needed (from equipment and moving vessel) in the design. Provide appropriate pressure compensating method in the discharge piping and sealing system per compressor manufacturer recommendation.	15.2 Supply pressure to FGSS 2-stroke engine – Vessel - Fuel Gas Supply System (FGSS) for Engine and TCD	Resolved	RESOLVED, refer to PID-AIP-2202-05-18 revD update. Sheet 1, note 3.
112	For HP system, conduct vibration analysis (from equipment and moving vessel) for the entire system and incorporate in the design and provide appropriate pressure compensating method in the discharge piping.	15.2 Supply pressure to FGSS 2-stroke engine – Vessel - Fuel Gas Supply System (FGSS) for Engine and TCD	Resolved	RESOLVED, refer to PID-AIP-2202-05-18 revD update. Sheet 1, note 3.
113	Develop integration plan and specifications for inlet pressures of FGSS and proper control system are to be provided to ensure operating conditions (pressure, flow rate) from FGSS to TCD system are within specific limit.	15.3 Incoming pressure from FGSS to TCD system (4-stroke and 2-stroke engines) – Vessel - Fuel Gas Supply System (FGSS) for Engine and TCD	In Progress	
114	Conduct transient analysis from the initiation of temperature shutdown to see the temperature distribution in the piping	15.4 Temperature at inlet of TCD system – Vessel - Fuel Gas Supply System (FGSS) for Engine and TCD	In Progress	
115	Add temperature monitoring to LNG vapouriser including temperature alarm and shutdown, and interlock with TCD system inlet valves shutdown.	15.4 Temperature at inlet of TCD system – Vessel - Fuel Gas Supply System (FGSS) for Engine and TCD	Resolved	RESOLVED, refer to PID-AIP-2202-05-18 revD update. : Added temperature signal from LNG Vapouriser to TCD system on sheet 1
116	Conduct temperature analysis from TCD system to FGSS system (before GVU) and provide appropriate operating temperature in detailed engineering phase.	15.5 Temperature from TCD system to FGSS – Vessel - Fuel Gas Supply System (FGSS) for Engine and TCD	In Progress	
117	Engine manufacturer has to type test engine and engine materials at selected fuel mixture for H <sub>2</sub> application.	19.1 Decomposition gas pressure and temperature – Vessel - Engine/Consumer	In Progress	
118	Engine manufacturer and Rotoboost has to develop monitoring system (i.e. engine RPM monitoring) for fuel mixture to optimise engine output, due to % variation of composition gas and CH <sub>4</sub> . Monitoring system has to be considered in the design of FGSS and TCD system.	19.1 Decomposition gas pressure and temperature – Vessel - Engine/Consumer	In Progress	
119	Requirements from manufacturer and FGSS are to be incorporated into final temperature selection for TCD system.	19.1 Decomposition gas pressure and temperature – Vessel - Engine/Consumer	In Progress	
120	Verify supply pressure requirements for the engine fuel mixture (gaseous NG and H <sub>2</sub> ) and timing of fuel mixture injection.	19.1 Decomposition gas pressure and temperature – Vessel - Engine/Consumer	In Progress	
121	Verify NO <sub>x</sub> emissions from type testing of engine. Potential to increased NO <sub>x</sub> emissions from engine, due to higher temperature of combustion of H <sub>2</sub> . Optimise NO <sub>x</sub> emissions based on fuel mix and engine design.	19.2 Emissions (NO <sub>x</sub> ) – Vessel - Engine/Consumer	In Progress	

No.	Action	References	Status	Comment
122	During misfiring of 2-stroke engines, verify if the exhaust receiver and exhaust system are able to handle explosion pressure, i.e., H <sub>2</sub> explosion pressure is much higher than CH <sub>4</sub> .	19.2 Emissions (NO <sub>x</sub> ) – Vessel - Engine/Consumer	In Progress	
123	cross contamination of auxiliary systems needs to be assessed for H <sub>2</sub> application.	19.2 Emissions (NO <sub>x</sub> ) – Vessel - Engine/Consumer	In Progress	Will use conservative design and establish SOP to avoid cross contamination issues.
124	Vent mass design for TCD venting to be based on appropriate class rules and IGF requirements for the vent mass location and vent mast height.	20.1 Vent mast for TCD system venting (product carrier and VLCC) – Vessel - Ventilation and Venting System 20.2 Vent mast for TCD system venting (ferry) – Vessel - Ventilation and Venting System	In Progress	
125	Consider locating vent mast with FGSS system vent mast of the vessel.	20.1 Vent mast for TCD system venting (product carrier and VLCC) – Vessel - Ventilation and Venting System 20.2 Vent mast for TCD system venting (ferry) – Vessel - Ventilation and Venting System	In Progress	
126	Vent mass are to be located away from exhaust vent to avoid any recirculation or overlap of hazardous areas.	20.2 Vent mast for TCD system venting (ferry) – Vessel - Ventilation and Venting System	In Progress	
127	Consider providing ESD upon inlet gas detection and closing of all the openings.	20.3 Ventilation for TCD system (installation specific issues for product carrier and VLCC) – Vessel - Ventilation and Venting System	Resolved	RESOLVED, refer to PID-AIP-2202-05-18 revD update. Added flammable gas detectors AE-0004 & AE-0005 at the inlet of Ventilation system of TCD
128	Investigate vent mast exhaust locations for the ferry, consider passenger proximity and other safe area proximity.	20.4 Ventilation for TCD system (installation specific issues for ferry) – Vessel - Ventilation and Venting System	In Progress	
129	Proper study is to be conducted considering other vents and openings, and proper separations are to be provided.	20.5 Vent mass arrangement for exhaust gas venting (product carrier and VLCC) – Vessel - Ventilation and Venting System	In Progress	
130	Consider adding sufficient distance between the other vent masts on vessel (product carrier or VLCC), or vent masts on FGSS system and the TCD system exhaust vent mast.	20.5 Vent mass arrangement for exhaust gas venting (product carrier and VLCC) – Vessel - Ventilation and Venting System	In Progress	
131	Exhaust ventilation is to be designed such that the radiant heat will not interfere with ferry passenger exposure.	20.6 Vent mass arrangement for exhaust gas venting (ferry) – Vessel - Ventilation and Venting System	In Progress	
132	IGF code requires thermal relief to be provided in case of fire for any trapped fluids. Alternatively, this can be justified via risk assessment considering gaseous inventories.	21.1 Active firefighting (for VLCC and product carrier) – Vessel - Safety Systems (F&G Detection, Active & Passive Firefighting, etc.)	Resolved	RESOLVED, refer to PID-AIP-2202-05-18 revD update. Add PSV for cooling water thermal relief on cooling water system
133	Investigate interface between Vessel fire & gas detection system and TCD control and detection systems in case of external fire impacting TCD system. Proper protocols to be established.	21.1 Active firefighting (for VLCC and product carrier) – Vessel - Safety Systems (F&G Detection, Active & Passive Firefighting, etc.)	In Progress	
134	Per IGF code, in case of vent mast fire, consider fire extinguishing system and drain connection in case of water accumulation in the bottom.	21.1 Active firefighting (for VLCC and product carrier) – Vessel - Safety Systems (F&G Detection, Active & Passive Firefighting, etc.)	In Progress	

No.	Action	References	Status	Comment
135	Firefighting for fuel room in ferry are to be considered per IGF code and SOLAS requirements.	21.2 Active firefighting (for ferry) – Vessel - Safety Systems (F&G Detection, Active & Passive Firefighting, etc.)	In Progress	
136	Consider providing ventilation rates such that, with the limited inventory in the TCD system, it will never achieve the explosive limit.	21.2 Active firefighting (for ferry) – Vessel - Safety Systems (F&G Detection, Active & Passive Firefighting, etc.)	In Progress	Gas dispersion analysis has been conducted under 30 ACH incoming flow rate inside the TCD system and the results showed that the volume fraction of H <sub>2</sub> is below than 0.33 % of the total volume of the air in the TCD system, which is below the LEL of H <sub>2</sub> of 4 %. The dispersion also indicates that the Hydrogen gas will flow upwards and towards the outlet duct due to the low pressure applied by the outlet fans. To reach the dangerous Hydrogen/ air mixture (30%-70%) a volume equivalent to the size of the reactor must be reached and that will not happen with 30 ACH flow capacity. For the upper explosion limit of 75% the excess Hydrogen molecules will remain unignited due to the absence of oxygen molecules. Therefore, a lean mixture is considered a higher risk due to the higher explosion intensity.
137	Investigate the need for backup fuel for TCD system for long-term or short-term supply shutdown.	22.1 Predetermined shutdown of FGSS or engine – Vessel - Ship Operation/Simultaneous operation 22.3 TCD system running while vessel is in port – Vessel - Ship Operation/Simultaneous operation	In Progress	Defer to Detailed Engineering Phase.  TCD system cannot operate normally if FGSS is not operational. Depending on location of TCD system, the operation may be forbidden by rules during cargo operations as extended safety precaution. For more details, see response to Recommendation 65.
138	Proper study to be conducted on how to vent off produced hydrogen, and if the burner in Reactor needs to be in operation, consider appropriate measures to keep Reactor hot or in operating conditions.	22.2 Emergency or upset shutdown of FGSS or engine – Vessel - Ship Operation/Simultaneous operation	In Progress	
139	Thermal analysis is to be done considering the number of start/stop cycles of TCD system.	22.2 Emergency or upset shutdown of FGSS or engine – Vessel - Ship Operation/Simultaneous operation	In Progress	
140	Investigate if TCD system has to be operational while vessel is in port, consider any impact due to local regulations, administrations, or class society rules. Investigate the need for liquid backup fuel for TCD system in case system has to be maintained in hot conditions.	22.3 TCD system running while vessel is in port – Vessel - Ship Operation/Simultaneous operation	In Progress	Defer to Detailed Engineering Phase.  TCD system cannot operate normally if FGSS is not operational. Depending on location of TCD system, the operation may be forbidden by rules during cargo operations as extended safety precaution. For more details, see response to Recommendation 65.
141	Conduct detailed safe working procedures for TCD container or TCD space entrance, when system is running and develop proper training for personnel, including emergency response.	23.1 Personnel working inside TCD system container (product carrier or VLCC) – Vessel - Emergency Escape, Evacuation, and Rescue (EER) 23.2 Personnel working inside TCD space inside fuel room (ferry) – Vessel - Emergency Escape, Evacuation, and Rescue (EER)	In Progress	

No.	Action	References	Status	Comment
142	Analyze human comfort levels for personnel working in TCD system container for an extended period. Determine appropriate time limit and incorporate into TCD system procedures.	23.1 Personnel working inside TCD system container (product carrier or VLCC) – Vessel - Emergency Escape, Evacuation, and Rescue (EER) 23.2 Personnel working inside TCD space inside fuel room (ferry) – Vessel - Emergency Escape, Evacuation, and Rescue (EER)	In Progress	Based on current simulation we are confident that for most cases ISO-container internal operation temperature will not be higher than 45 degree Celsius. Additional studies to be carried out at later stage
143	Temperature management for TCD system container are to be determined.	23.1 Personnel working inside TCD system container (product carrier or VLCC) – Vessel - Emergency Escape, Evacuation, and Rescue (EER) 23.2 Personnel working inside TCD space inside fuel room (ferry) – Vessel - Emergency Escape, Evacuation, and Rescue (EER)	Resolved	RESOLVED, refer to PID-AIP-2202-05-18 revD update. Added TE-0002 inside the Container.
144	Operational risk assessments or Job Safety Analysis (JSA) are to be conducted if personnel are expected to work in TCD system container or space for extended period.	23.1 Personnel working inside TCD system container (product carrier or VLCC) – Vessel - Emergency Escape, Evacuation, and Rescue (EER) 23.2 Personnel working inside TCD space inside fuel room (ferry) – Vessel - Emergency Escape, Evacuation, and Rescue (EER)	In Progress	
145	Weather limitations are to be developed if personnel are expected to work in TCD container.	23.1 Personnel working inside TCD system container (product carrier or VLCC) – Vessel - Emergency Escape, Evacuation, and Rescue (EER) 23.2 Personnel working inside TCD space inside fuel room (ferry) – Vessel - Emergency Escape, Evacuation, and Rescue (EER)	In Progress	
146	Consider adding door alarms when the TCD container door is open.	23.1 Personnel working inside TCD system container (product carrier or VLCC) – Vessel - Emergency Escape, Evacuation, and Rescue (EER)	In Progress	
147	TCD space inside fuel room of ferry to maintain negative pressure compared to surrounding (typically requires exhaust fans)	23.2 Personnel working inside TCD space inside fuel room (ferry) – Vessel - Emergency Escape, Evacuation, and Rescue (EER)	In Progress	
148	When using flare gas or produced gas from offshore installations to feed TCD system, offshore gas compositions are to be studied and impact on salt or catalysts are to be further investigated.	24.1 TCD system using flare gas or produced gas from FPSO - to use in turbine/engine or export – Offshore installation	In Progress	
149	Carbon produced from offshore produced gas or flare gas is to be studied for any radioactive or contaminants which can hinder transportation and storage.	24.1 TCD system using flare gas or produced gas from FPSO - to use in turbine/engine or export – Offshore installation	In Progress	
150	Produced carbon is to be evaluated for resale value, and if not marketable, then disposals of carbons are to be studied.	24.1 TCD system using flare gas or produced gas from FPSO - to use in turbine/engine or export – Offshore installation	In Progress	
151	Need for pre-treatment of flare gas need to be evaluated for use in TCD system.	24.1 TCD system using flare gas or produced gas from FPSO - to use in turbine/engine or export – Offshore installation	In Progress	
152	Investigate compressing H <sub>2</sub> in storage tank and exporting	24.1 TCD system using flare gas or produced gas from FPSO - to use in turbine/engine or export – Offshore installation	In Progress	

No.	Action	References	Status	Comment
153	Percentage of H <sub>2</sub> that can be burned in turbine and engine need to be investigated.	24.1 TCD system using flare gas or produced gas from FPSO - to use in turbine/engine or export – Offshore installation	In Progress	
154	Storage of carbon produced, and offloading are to be further investigated	24.1 TCD system using flare gas or produced gas from FPSO - to use in turbine/engine or export – Offshore installation	In Progress	

## Appendix XIII – HAZID Register CH4 to H2 Technology

No.: 1		TCD System - Feed gas, Gas Sweetening, Feed Gas Preheater							
Item	Deviation	Causes	Consequences	Safeguards	Matrix	S	L	R	Action Items
1.1	Impurity in incoming gas	1. LNG is out of spec <b>Deviation/Cause:</b> High sulphur content	1. Reactor Catalyst will be less effective short-term	1. Sweetener unit to remove acidic components 2. LNG only contains trace amount (less than 1 PPM) of sulphur 3. Efficiency monitoring of process (catalyst) 9. Catalyst can be regenerated in the process 10. Two Sweetener unit, normally need one per spec, can run in series or parallel	Asset	2	B	Low	1. Sweetening Absorber change out, maintenance philosophy, and materials are to be developed. <b>Status:</b> In Progress
			2. Sweetening Absorber life expectancy will decrease		Asset	1	B	Low	
			3. Nickel sulfide will form in Reactor		Asset	1	B	Low	
		2. N <sub>2</sub> in incoming LNG	4. Formation of ammonia (overall impact to personnel, environmental, asset)	4. Pressure and temperature after reactor is below threshold for ammonia formation	Overall	S3-Moderate	LA-Rare	Moderate	
		3. Potential for CO <sub>2</sub> to form, but there is no significant issues. CO <sub>2</sub> content in LNG is below the threshold.							
		4. Higher percentage of N <sub>2</sub> during startup, since N <sub>2</sub> is used as purge gas. No significant issues.							
		5. CH <sub>4</sub> + in feed gas stream	5. CH <sub>4</sub> + passing through the system, leading to process upset	5. CH <sub>4</sub> + will easily breakdown in the reactor (1 molecule less of H <sub>2</sub> )	Asset	1	B	Low	

No.: 1		TCD System - Feed gas, Gas Sweetening, Feed Gas Preheater							
Item	Deviation	Causes	Consequences	Safeguards	Matrix	S	L	R	Action Items
		6. Debris or corrosion product in feed gas	6. Choking of Sweetener unit, leading to process delay	6. All piping are Stainless Steel (SS) piping 7. Mechanical filter upstream of Sweetener unit will collect debris. 8. Absorber materials is not harmful to human.	Asset	2	B	Low	1. Sweetening Absorber change out, maintenance philosophy, and materials are to be developed. <b>Status:</b> In Progress
1.2	Availability of feed gas at correct temperature and pressure	1. FGSS is not designed to supply LP fuel gas when feed gas pressure is above operating pressure (applies to MAN system, for LP system it is not an issue) <b>Deviation/Cause:</b> High Pressure	1. Mechanical damage (connection leaks, seal leaks or failures) upstream of PV-0501	1. Pressure Control Valves within Rotoboost Battery Limit will control downstream pressure 2. Pressure monitoring downstream of PV-0501 (pressure transmitter PT-0501 has alarms and shutdowns) 6. Piping system and components are designed to the same pressure as the relief valve in upstream piping 9. Pressure monitoring: PIT-1010 will provide pressure monitoring at Battery Limit, initiate alarms and shutdowns (L, H, HH, LL)	Asset	2	B	Low	2. Add high pressure monitoring and shutdown on incoming upstream feed gas stream (near TE-1002) <b>Status:</b> Resolved
			2. Inefficient TCD process		Asset	2	C	Moderate	
		2. Low pressure incoming feed gas <b>Deviation/Cause:</b> Low Pressure	3. Reaction temperatures higher than operating limit due to low flow feed gas, leads to higher decomposition gas temperature	3. Reactor tubes are designed for 900 degC, tube material is designed for 1100 degC, and operating temperature is 800 to 850 degC. 4. Low pressure monitoring downstream of PV-0501 will shut down the system (pressure transmitter PT-0501)	Asset	2	C	Moderate	3. Provide interlock and LL shutdown at PT-1002 to close inlet valve after sequence. <b>Status:</b> Resolved 4. Any Reactor tubes which see direct radiation heat from the burner are to be monitor or analysed to see what the temperature on the outside surface of the tubes is. <b>Status:</b> In Progress

No.: 1		TCD System - Feed gas, Gas Sweetening, Feed Gas Preheater							
Item	Deviation	Causes	Consequences	Safeguards	Matrix	S	L	R	Action Items
				5. Pressure Transmitter PT-1002 will provide pressure monitoring, and alarms operator at L alarm (alarm only on P&ID) 7. Temperature monitoring: TI-1002A/B at 010R01 Decomposition Reactor will initiate H alarm and HH shutdown 8. Burner management system will adjust and provide appropriate heat input 9. Pressure monitoring: PIT-1010 will provide pressure monitoring at Battery Limit, initiate alarms and shutdowns (L, H, HH, LL)					5. Add HH temperature shutdown to temperature indicator TI-1002 at the decomposition gas outlet of Reactor. <b>Status:</b> Resolved
			4. Decreased H <sub>2</sub> generation (due to less fuel supply)		Asset	1	C	Low	
			5. Reactor tubes damage due to higher reaction temperatures		Overall	S3-Moderate	LC-Possible	High	
		3. Unintended flow from HP incoming gas to LP decomposition gas side in Preheater (see 1.7)							
1.3	flow rate of incoming gas	1. Control valve fails open (PV-0501 or FV-0501 on the inlet natural gas stream) <b>Deviation/Cause:</b> High Flow	1. Lower gas preheating outlet temperature and reaction temperature in Reactor	1. Engine control system will adjust the flow rate of CH <sub>4</sub> and H <sub>2</sub> 3. Temperature monitoring: TI-2002 on the DG stream at the outlet of Feed Gas Preheater will initiate alarms (H, L)	Asset	1	C	Low	



No.: 1		TCD System - Feed gas, Gas Sweetening, Feed Gas Preheater							
Item	Deviation	Causes	Consequences	Safeguards	Matrix	S	L	R	Action Items
				13. Temperature monitoring (TI-1004) at natural gas inlet of Reactor will initiate low or high alarm					
			2. Decreased in efficiency and yield rate due to low temperature and high flow rate of natural gas		Asset	2	C	Moderate	
			3. Engine performance issue due to lower H <sub>2</sub>		Asset	3	B	Moderate	
			8. Partial sweetening of methane due to high flow rate		Asset	2	C	Moderate	
		2. Control valve malfunctions (partially open, similar to low pressure scenarios in section 1.2.2) (see 1.2) <b>Deviation/Cause:</b> Low Flow	3. Engine performance issue due to lower H <sub>2</sub>	1. Engine control system will adjust the flow rate of CH <sub>4</sub> and H <sub>2</sub> 2. Temperature monitoring: TI-1002A/B at 010R01 Decomposition Reactor will initiate alarm and shutdown (H, HH) 3. Temperature monitoring: TI-2002 on the DG stream at the outlet of Feed Gas Preheater will initiate alarms (H, L) 8. Flow control (FE-0501) to alarm and shutdown 10. Preheater will be designed to handle incoming decomposition gas and molten salt temperature from Reactor 13. Temperature monitoring (TI-1004) at natural gas inlet of Reactor will initiate low or high alarm	Asset	3	B	Moderate	3. Provide interlock and LL shutdown at PT-1002 to close inlet valve after sequence. 4. Any Reactor tubes which see direct radiation heat from the burner are to be monitor or analysed to see what is the temperature on the outside surface of the tubes. <b>Status:</b> In Progress 5. Add HH temperature shutdown to temperature indicator TI-1002 at the decomposition gas outlet of Reactor. <b>Status:</b> Resolved

No.: 1		TCD System - Feed gas, Gas Sweetening, Feed Gas Preheater							
Item	Deviation	Causes	Consequences	Safeguards	Matrix	S	L	R	Action Items
				14. Pressure monitoring: PIT-1010 will provide pressure monitoring at Battery Limit, initiate alarms and shutdowns (L, H, HH, LL)					
			4. High temperature gas at the Reactor inlet		Asset	2	C	Moderate	
			5. Decreased flow rate to Reactor and increasing temperature in Reactor and decomposition gas		Asset	3	B	Moderate	
			6. Degraded materials in Reactor tubes due to high temperature		Asset	3	B	Moderate	
			7. Reaction temperatures higher than operating limit due to low flow feed gas, leads to higher decomposition gas temperature		Asset	2	C	Moderate	
		3. LNG supply natural gas pump failure or interrupted incoming gas <b>Deviation/Cause:</b> Low Flow	3. Engine performance issue due to lower H <sub>2</sub>		Asset	3	B	Moderate	6. Interface and communication protocol between FGSS and Rotoboost system is to be established in detailed engineering phase for proper monitoring and shutdown. <b>Status:</b> In Progress
			4. High temperature gas at the Reactor inlet		Asset	2	C	Moderate	
			5. Decreased flow rate to Reactor and increasing temperature in Reactor and decomposition gas		Asset	3	B	Moderate	
			6. Degraded materials in Reactor tubes due to high temperature		Asset	3	B	Moderate	

No.: 1		TCD System - Feed gas, Gas Sweetening, Feed Gas Preheater							
Item	Deviation	Causes	Consequences	Safeguards	Matrix	S	L	R	Action Items
			7. Reaction temperatures higher than operating limit due to low flow feed gas, leads to higher decomposition gas temperature		Asset	2	C	Moderate	
		4. Sweetening Absorber is 100% saturated (see 1.5)							
		5. Sweetening Absorber is 100% saturated (see 1.5)							
1.4	Methane leakage	1. Mechanical failure, seal failure, connection failure	1. Methane gas leakage inside TCD container	1. Flammable Gas Detection inside container (20% of LEL) will initiate alarm and shutdown 2. Flammable Gas Detection at exhaust ducts inside container 3. Fire Detection inside container 4. Blowout panels on container to safe location to minimise damage due to explosion due to detonation 5. ESD initiate by fire & gas detection inside and at exhaust ducts inside container based on various setpoints 6. Firefighting Systems (CO <sub>2</sub> ) 7. TCD container ventilation system 8. Ventilation exhaust location is in compliance with codes, standards, regulations, or class society rules	Overall	S1-Low	LD-Likely	Moderate	7. Conduct Gas Dispersion analysis and Fire & Explosion analysis to understand fire and explosion hazards. Provide appropriate mitigation measures for firefighting system. <b>Status:</b> In Progress
			2. Methane gas leakage at TCD container exhaust		Overall	S2-Minor	LC-Possible	Moderate	

No.: 1		TCD System - Feed gas, Gas Sweetening, Feed Gas Preheater							
Item	Deviation	Causes	Consequences	Safeguards	Matrix	S	L	R	Action Items
			3. Fire & Explosion		Overall	S3-Moderate	LB-Unlikely	Moderate	
			4. Damage to TCD container and vessel		Asset	3	B	Moderate	
1.5	Sweetening Absorber is 100% saturated	1. Higher sulphur % than expected	1. catalysts will form nickel sulfide, leading to decreased yield rate in the Reactor	1. Catalyst is continuously regenerated by the hydrogen stream into H <sub>2</sub> S (hydrogen sulfide) 2. H <sub>2</sub> S % is the same as incoming gas stream, with no issues 3. Periodic visual inspection of Absorber through sight glass by operator 4. Absorber is operating in series at 200% design lifetime capacity (1st unit operates at 100%, 2nd unit operates at 50%)	Asset	2	B	Low	
		2. Absorber internal design is not suitable	2. Decreased efficiency of sulphur removal	5. Absorber unit will be tested and designed for similar applications	Asset	3	B	Moderate	
			3. Decreased life span of Absorber units		Asset	3	B	Moderate	
			4. Increased in backpressure		Asset	2	B	Low	
		3. Plugging of Absorber unit in operating in series	5. Low flow rate in upstream and downstream (due to plugged Absorber) (see 1.3)	6. Filters upstream of Absorber units 7. LNG is clean service 8. Stainless Steel (SS) piping					8. During fabrication and installation, proper cleaning procedures are to be developed to remove any debris from piping, to minimise plugging in the system. <b>Status:</b> In Progress
			6. Higher pressure upstream (due to plugged Absorber) (see 1.3)						

No.: 1		TCD System - Feed gas, Gas Sweetening, Feed Gas Preheater							
Item	Deviation	Causes	Consequences	Safeguards	Matrix	S	L	R	Action Items
1.6	CO <sub>2</sub> in incoming stream	1. Potential for CO to form from CO <sub>2</sub> , but there is no significant consequence identified. CO <sub>2</sub> content in LNG is below the threshold.							
1.7	Unintended flow from HP incoming gas to LP decomposition gas side in Preheater	1. Pinhole leak in Preheater exchanger	2. Natural gas in decomposition gas stream	2. Regular maintenance and inspection conducted annually, including leak monitor testing of Preheater exchanger. 3. During Startup, leak testing of equipment, including Preheater, is conducted.	Asset	2	B	Low	
		2. Tubes failure in Preheater exchanger	1. Decreased flow to Reactor	1. Temperature monitoring at decomposition gas inlet and outlet, and natural gas outlet of Preheater 2. Regular maintenance and inspection conducted annually, including leak monitor testing of Preheater exchanger. 3. During Startup, leak testing of equipment, including Preheater, is conducted. 4. Engine control system will adjust the flow rate of CH <sub>4</sub> and H <sub>2</sub>	Asset	3	B	Moderate	
			2. Natural gas in decomposition gas stream		Asset	2	B	Low	
			3. Engine performance issue		Asset	2	B	Low	
			4. Low flow and high temperature inside Reactor (see 1.2)						

No.: 2		TCD System - Feed Gas Decomposition Reactor							
Item	Deviation	Causes	Consequences	Safeguards	Matrix	S	L	R	Action Items
2.1	Explosion inside Reactor	1. Sequence failure to start the combustion chamber	1. Explosive mixture inside combustion chamber due to unburned CH <sub>4</sub> , leading to damage to Reactor shell (Overall)	1. Purge cycle before burner start and after burner stop in Reactor 2. Electrical heating jolt to start the inlet ignition 3. Burner Management System for the Reactor 4. Rupture disk on combustion chamber of Reactor to relieve explosion pressure 5. Container has a blowout panel to relieve explosion pressure 6. Air to gas ratio is monitored during startup to avoid explosion	Overall	S3-Moderate	LB-Unlikely	Moderate	9. Explosion damage to be evaluated to understand explosion impact on container, equipment and Reactor. <b>Status:</b> Resolved 10. Conduct study for where the explosion gases will go from pressure relief panel from TCD container top to relieve pressure from container. <b>Status:</b> In Progress
			2. Explosion inside Reactor due to H <sub>2</sub> leak (Overall)		Overall	S3-Moderate	LC-Possible	High	
		2. Improper purging sequence	1. Explosive mixture inside combustion chamber due to unburned CH <sub>4</sub> , leading to damage to Reactor shell (Overall)	1. Purge cycle before burner start and after burner stop in Reactor 2. Electrical heating jolt to start the inlet ignition 3. Burner Management System for the Reactor 4. Rupture disk on combustion chamber of Reactor to relieve explosion pressure 5. Container has a blowout panel to relieve explosion pressure 6. Air to gas ratio is monitored during startup to avoid explosion	Overall	S3-Moderate	LB-Unlikely	Moderate	9. Explosion damage to be evaluated to understand explosion impact on container, equipment and Reactor. <b>Status:</b> Resolved 10. Conduct study for where the explosion gases will go from pressure relief panel from TCD container top to relieve pressure from container. <b>Status:</b> In Progress
			2. Explosion inside Reactor due to H <sub>2</sub> leak (Overall)		Overall	S3-Moderate	LC-Possible	High	

No.: 2		TCD System - Feed Gas Decomposition Reactor							
Item	Deviation	Causes	Consequences	Safeguards	Matrix	S	L	R	Action Items
2.2	Combustion temperature inside Reactor	1. Low Temperature inside Reactor (below 800 degC) <b>Deviation/Cause:</b> Low Temperature	1. Solidification of catalyst and salt (see 2.10)	1. Monitoring of 3 sight glasses on Reactor tubes to monitor tubes colour, which provides temperature estimation 2. Temperature monitoring of combustion gas 3. Temperature monitoring: TI-1002A/B at 010R01 Decomposition Reactor will initiate alarm and shutdown (H, HH) 4. Temperature monitoring of feed gas at Reactor inlet 5. In case temperature falls below operating condition, Reactor is automatically in temporary standby mode to reduce feed gas flow with burner still operating to recover back to operating temperature 6. Normal shutdown of Reactor and process 7. Temperature monitoring of gas at the hollow tubes' outlet of Reactor (TE-1001A&B)	Asset	3	C	High	
			2. Decreased efficiency to generate composition gas		Asset	1	B	Low	
		2. High Temperature inside Reactor <b>Deviation/Cause:</b> High Temperature	3. Degradation of materials in Reactor tubes, leading to failure of feed gas tubes inside Reactor (long term)	1. Monitoring of 3 sight glasses on Reactor tubes to monitor tubes colour, which provides temperature estimation 2. Temperature monitoring of combustion gas	Asset	3	C	High	4. Any Reactor tubes which see direct radiation heat from the burner are to be monitor or analysed to see what is the temperature on the outside surface of the tubes. <b>Status:</b> In Progress

No.: 2		TCD System - Feed Gas Decomposition Reactor							
Item	Deviation	Causes	Consequences	Safeguards	Matrix	S	L	R	Action Items
				3. Temperature monitoring: TI-1002A/B at 010R01 Decomposition Reactor will initiate alarm and shutdown (H, HH) 4. Temperature monitoring of feed gas at Reactor inlet 6. Normal shutdown of Reactor and process 7. Temperature monitoring of gas at the hollow tubes' outlet of Reactor (TE-1001A&B)					5. Add HH temperature shutdown to temperature indicator TI-1002 at the decomposition gas outlet of Reactor. <b>Status:</b> Resolved
			4. Higher unit fuel consumption (efficiency issue)		Asset	1	B	Low	
			5. Leakage of catalyst or salt inside Reactor		Asset	3	C	High	
			6. Increased thermal fatigue rate (long term)		Asset	2	C	Moderate	
		3. Natural gas flow to Reactor (see 2.5)							
		4. Solidification (see 2.10)							
		5. Natural gas flow to Reactor (see 2.5)							
2.3	Catalyst level inside Reactor	1. Low level of catalyst inside Reactor <b>Deviation/Cause:</b> Low level	1. Decreased efficiency in Reactor	1. Ability to add catalyst and salt mixture to Reactor tubes upon detection of low level using 012P01 Molten Salt Recirculation Pump to maintain recirculation 2. Temperature monitoring of exhaust gas temperature 3. Temperature monitoring of decomposition gas	Asset	2	C	Moderate	11. Catalyst solids and salts are stored in feeding units, close to the Decomposition Gas Buffer Tank. Location to be studied with respect to installed vessel and its requirements. <b>Status:</b> In Progress  12. Further studies are to be done and further applications to be provided to minimise low level in Reactor. <b>Status:</b> In Progress



No.: 2		TCD System - Feed Gas Decomposition Reactor							
Item	Deviation	Causes	Consequences	Safeguards	Matrix	S	L	R	Action Items
				4. Monitoring of 3 sight glasses on Reactor tubes to monitor tubes colour, which provides temperature estimation					
			2. High temperature in Reactor tubes due to gas phase or carbon phase radiant heat exposure		Overall	S3-Moderate	LC-Possible	High	
		2. High level of catalyst inside Reactor <b>Deviation/Cause:</b> High level	3. Inability to remove carbon from natural gas, leading to more catalyst to Molten Salt Separator, causing decreased purity in decomposition gas stream	5. Two units of 4 stage filters (Carbon Filters 020F01A/B) will remove carbon from decomposition gas 6. Feed Gas Preheater will also remove carbon from decomposition gas stream	Asset	3	C	High	5. Add HH temperature shutdown to temperature indicator TI-1002 at the decomposition gas outlet of Reactor. <b>Status:</b> Resolved 12. Further studies are to be done and further applications to be provided to minimise low level in Reactor. <b>Status:</b> In Progress 13. Further studies to be done to determine ratio of salt and catalyst, and level monitoring of catalyst and salt in Reactor tubes. <b>Status:</b> In Progress
2.4	Salt Level inside Reactor	1. Low level salt inside Reactor (see 2.3) <b>Deviation/Cause:</b> High level 2. High level salt inside Reactor (see 2.3) <b>Deviation/Cause:</b> Low level							
2.5	Natural gas flow to Reactor	1. Low gas flow to Reactor (see 1.3) <b>Deviation/Cause:</b> Low Flow	1. Higher temperature in reactor tubes (see 2.2)	1. Flow monitoring (FE-0501) of feed gas stream and burner interlock (burner temperature will adjust based on flow rate)					

No.: 2		TCD System - Feed Gas Decomposition Reactor							
Item	Deviation	Causes	Consequences	Safeguards	Matrix	S	L	R	Action Items
		2. High gas flow to Reactor (see 1.3) <b>Deviation/Cause:</b> High Flow	2. Decreased efficiency on Reactor (see 2.2)	1. Flow monitoring ( FE-0501) of feed gas stream and burner interlock (burner temperature will adjust based on flow rate)					
2.6	combustion air flow or gas flow to Reactor	1. High combustion air flow to Reactor or lower gas flow <b>Deviation/Cause:</b> High Flow	1. Lower temperature in combustion chamber of Reactor	1. Burner Management system in Reactor 2. Temperature monitoring in Reactor combustion chamber (TE-1003 and TE-1003B) 3. Oxygen content monitoring in exhaust gas stream to adjust air flow	Asset	2	C	Moderate	
			2. Lower temperature in exhaust gas stream, leading to lower heating temperature of feed gas		Asset	2	C	Moderate	
			3. Decreased efficiency in combustion leading to higher consumption of gas		Asset	2	B	Low	
			7. Decreased efficiency of Reactor due to low combustion temperature		Asset	2	C	Moderate	
		2. Low combustion air flow to Reactor or higher gas flow <b>Deviation/Cause:</b> Low Flow	1. Lower temperature in combustion chamber of Reactor	1. Burner Management system in Reactor 2. Temperature monitoring in Reactor combustion chamber (TE-1003 and TE-1003B) 3. Oxygen content monitoring in exhaust gas stream to adjust air flow 4. Oxygen Content monitoring: OIC-1001 oxygen analyzer will initiate alarm and shutdown (H, HH, L, LL) and interlock with Burner management system	Asset	2	C	Moderate	14. Add LL shutdown to OIC-1001 oxygen analyzer shutdown, interlock with Burner Management system. <b>Status:</b> Resolved 15. Add H alarm and HH shutdown and appropriate setpoints to LEL-1001 flammable gas detector in exhaust gas outlet of Reactor. <b>Status:</b> Resolved

No.: 2		TCD System - Feed Gas Decomposition Reactor							
Item	Deviation	Causes	Consequences	Safeguards	Matrix	S	L	R	Action Items
				5. Flammable Gas Detector AI-1001 at the exhaust gas outlet of 010R01 Decomposition Reactor will initiate alarm and shutdown (H, HH)					16. Installation specific requirements to be followed per regulations and class society rules. <b>Status:</b> In Progress
			2. Lower temperature in exhaust gas stream, leading to lower heating temperature of feed gas		Asset	2	C	Moderate	
			4. Incomplete combustion leading to smoke coming out of exhaust gas venting system of container		Environmental	3	B	Moderate	
			5. Unburned gas into the exhaust gas piping and vent mast outlet		Environmental	3	B	Moderate	
			8. Additional hazardous areas at the vent outlet		Asset	2	C	Moderate	
2.7	exhaust gas Venting	1. Lightning and incomplete combustion (requires 2 event to happen at the same time)	1. Flash back explosion due to lightning igniting unburned gas	1. Burner Management System in Reactor 2. Proper design of vent piping and vent mast	Asset	2	B	Low	16. Installation specific requirements to be followed per regulations and class society rules. <b>Status:</b> In Progress
		2. exhaust gas pressure and temperature - TCD System - Feed Gas Final Preheater (see 4.1)							
2.8	Temperature inside container	1. High temperature inside container due to heat input from Reactor <b>Deviation/Cause:</b> High Temperature	2. Personnel exposure to high heat inside container	1. Personal Protection Equipment (PPE) are provided for personnel working inside container 2. Equipment and instrumentations (PLC, analyzers) inside container are to be designed to be maximum expected temperature (Class requirement)	Injury	2	D	High	18. Conduct heat calculations and ventilation studies to determine optimal air flow capacity and insulation need to maintain the inside temperature of TCD container. <b>Status:</b> In Progress

No.: 2		TCD System - Feed Gas Decomposition Reactor							
Item	Deviation	Causes	Consequences	Safeguards	Matrix	S	L	R	Action Items
				3. Container wall is A-60 fire rating. 4. Ventilation System is continuously running (30 air changes/hr) 5. Temperature monitoring inside the container will shut down unit 6. Container will be raised to 900 mm from deck. 7. All high temperature piping is insulated					19. From Human Ergonomic and human comfort perspective, provide suitable PPE and develop proper inspection and maintenance procedures to minimise personnel exposure to heat inside container. <b>Status:</b> In Progress
			3. Premature failure to electrical equipment, leading to equipment damage		Asset	3	B	Moderate	
			4. High temperature from container bottom impacting cargo tanks on vessel		Asset	3	B	Moderate	
		2. Low temperature of natural gas stream from FGSS inside the container <b>Deviation/Cause:</b> Low Temperature	1. Moisture condensation on piping and equipment due to low temperature inside container, leading to potential operator slips, trips, and falls.	1. Personal Protection Equipment (PPE) are provided for personnel working inside container	Injury	2	B	Low	17. Investigate if there is any possibility of condensation inside the container (due to low temperature) and provide proper insulation or drip trays. <b>Status:</b> In Progress
2.9	Leakage of exhaust gas inside container (Review Section 1)	1. exhaust gas piping crack or leakage	1. Human exposure to combustion products (CO <sub>2</sub> , CO, NO <sub>x</sub> ) and asphyxiation	1. Fixed oxygen detectors inside container 2. Portable oxygen detectors with PPE 3. TCD container has ventilation system (30 air changes/hr)	Injury	3	C	High	20. Proper maintenance and inspection procedures are to be developed for the system and equipment. <b>Status:</b> In Progress

No.: 2		TCD System - Feed Gas Decomposition Reactor							
Item	Deviation	Causes	Consequences	Safeguards	Matrix	S	L	R	Action Items
2.10	Solidification	1. Solidification inside discharge piping from O12P01 Molten Salt Recycle Pump to Reactor (potential causes: trapped fluid, elevation difference, and currently piping is not heat traced)	1. Inability to feed Reactor	1. electric motors have VFD drive and pump control system (O12P01 Molten Salt Recycle Pump ) 2. Overload protection will initiate controlled shutdown of Reactor and O12P01 Molten Salt Recycle Pump. 5. Pressure monitoring PI-1005 at discharge of O12P01 Molten Salt Pump will initiate alarm (H, L)	Asset	2	C	Moderate	22. Study issues of solidifications on pump discharge piping and provide appropriate solutions. <b>Status:</b> In Progress 23. Study the block discharge load on O12P01 Molten Salt Recycle Pump and include in VFD shutdown philosophy. 24. Consider providing pressure monitoring at the discharge of O12P01 Molten Salt Recycle Pump. <b>Status:</b> Resolved
			2. Controlled shutdown of Reactor, leading to inability to decompose CH <sub>4</sub>		Asset	2	C	Moderate	
			3. Pump overheating and pump damage		Asset	2	B	Low	
			4. Electrical fire from pump motor (due to pump overheating)		Asset	2	B	Low	
			5. Solidified materials inside discharge piping of Molten Salt Recycle Pump (O12P01)		Asset	3	C	High	
		2. Solidification inside discharge piping from Reactor to O12V01 Molten Salt Separator (mixture of carbon liquid, gas, solids)	6. Inability to discharge salt, carbon, decomposition gas from Reactor to O12V01 Molten Salt Separator	6. Pressure monitoring PI-1006 at the decomposition gas discharge manifold, forms PDC-1006 with PT-1002 to detect partial blockage inside discharge piping from O10R01 Decomposition Reactor	Asset	3	C	High	25. System has to provide some form of detection to detect solidification or partial blockage inside discharge piping from Reactor to Molten Salt Separator. <b>Status:</b> Resolved

No.: 2		TCD System - Feed Gas Decomposition Reactor							
Item	Deviation	Causes	Consequences	Safeguards	Matrix	S	L	R	Action Items
									28. Consider discharge piping with enough slope to Molten Salt Separator (012V01) <b>Status:</b> Resolved
		3. System shutdown due to upset conditions or controlled shutdown	7. Solidified salt and metals inside Reactor tubes and piping	3. Reactor is designed to withstand thermal expansion or contraction loads from liquid to solid, solid to liquid. 4. System is designed with startup sequence with N <sub>2</sub> to heat up solidified materials inside Reactor	Asset	3	B	Moderate	26. Study the need for draining the Reactor and Molten Salt Collection Tank (012V02) and other equipment or piping where solidification is a possibility due to leakage, other emergencies, or regular maintenance. Consider maintenance to be done in a marine environment. <b>Status:</b> Resolved
			8. Unable to drain from Reactor (salt and catalysts), creating potential maintenance issues		Asset	3	C	High	
		4. Breakage of piping due to expansion and contraction from liquid to solid, solid to liquid	9. Breakage of Reactor piping due to fatigue (due to material expansion/contraction and thermal load)	3. Reactor is designed to withstand thermal expansion or contraction loads from liquid to solid, solid to liquid.	Asset	3	C	High	21. Conduct detailed thermal analysis study to determine if material can stay in liquid form or can be solidified, leading to piping damage. <b>Status:</b> In Progress 27. Thermal expansion characteristics are to be developed for Reactor tubing, catalyst, and salt. <b>Status:</b> In Progress
		5. Emergency or upset shutdown of FGSS or engine - Vessel - Ship Operation/Simultaneous operation (see 22.2)							
		6. Combustion temperature inside Reactor (see 2.2)							

No.: 2		TCD System - Feed Gas Decomposition Reactor							
Item	Deviation	Causes	Consequences	Safeguards	Matrix	S	L	R	Action Items
		7. Hydrogen leak - TCD System - Ventilation system (see 8.1)							
2.11	Nitrogen (N <sub>2</sub> ) purge cycle	1. Impurities in N <sub>2</sub>	1. Degradation of catalyst and salt, or materials of the system						29. Quantity and storage need for nitrogen are to be evaluated and purity of nitrogen to be specified considering impact on the system. <b>Status:</b> In Progress
2.12	Decomposition gas and carbon in the system from Reactor outlet to Carbon Filters	1. Separation of carbon in the decomposition gas stream in the system piping (from Reactor outlet to Carbon Filters)	1. carbon accumulation in low points of system piping, leading to performance issue and blockage		Asset	3	D	High	30. Study the potential for carbon accumulation in low points in the system piping (downstream of Reactor) in detailed engineering phase. <b>Status:</b> In Progress 31. Study the suitability of system instrumentations for the decomposition gas stream systems up to Carbon Filters. Potential carbon accumulation and operating in carbon rich environment may lead to decreased accuracy/availability of system instrumentation. <b>Status:</b> In Progress
			2. Decrease accuracy of system instrumentations due to potential carbon accumulation around instrument		Asset	3	D	High	

No.: 3		TCD System - Molten Salt Separator (012V01) and Molten Salt Collection Tank (012V02)							
Item	Deviation	Causes	Consequences	Safeguards	Matrix	S	L	R	Action Items
3.1	Filter inside Molten Salt Separator (012V01)	1. Plugged filter inside Molten Salt Separator 012V01	1. Inability to separate salt and liquid metal inside Molten Salt Separator 012V01		Asset	3	C	High	32. Investigate possibility of blockage and develop philosophy for monitoring decomposition gas system to detect blockage. 33. Develop philosophy to cleaning the filter inside Molten Salt Separator (012V01) <b>Status:</b> In Progress
			2. Higher salt consumption		Asset	3	C	High	
3.2	Pressure management in Molten Salt Separator (012V01)	1. No significant issue with pressure management in Molten Salt Separator (012V01).							
3.3	Solidification inside Molten Salt Separator (012V01)	1. System shutdown	1. solidification in Molten Salt Separator (012V01)	1. Vessel is self-draining. 01201 Molten Salt Separator will drain to Molten Salt Collection Tank 012V02. 2. Exhaust gas circuit inside and start-up circuit with N <sub>2</sub> will liquify materials inside Molten Salt Separator (012V01)	Asset	1	C	Low	
		2. Hydrogen leak - TCD System - Ventilation system (see 8.1)							
3.4	Filter breakthrough inside Molten Salt Separator (012V01)	1. Filter breakthrough in Molten Salt Separator (012V01)	1. Potential carbon in 012V02 Collection Tank due to filter breakthrough	1. Molten Salt Recycle Pump 012P01 can handle some % of carbon 2. 012P02 Carbon re-mix agitator inside 012V02 Molten Salt Collection Tank with level deviation control	Asset	2	C	Moderate	34. Detection for filter breakthrough and any accumulation of carbons inside 012V02 Molten Salt Collection Tank are to be addressed from safety and operation perspective. <b>Status:</b> Resolved
			2. Not enough salt and catalyst available due to high % of carbon in 012V02 Collection Tank		Asset	2	C	Moderate	



No.: 3		TCD System - Molten Salt Separator (012V01) and Molten Salt Collection Tank (012V02)							
Item	Deviation	Causes	Consequences	Safeguards	Matrix	S	L	R	Action Items
3.5	exhaust gas Piping breakage	1. Exhaust gas piping breakage (fatigue crack, pinhole leak, thermal load) (same issue applies to exhaust gas stream in 012V01 Molten Salt Separator, 012V02 Molten Salt Collection Tank, 012E03 Feed Gas Final Preheater)	1. Decomposition gas or liquid salt in exhaust gas piping	1. Periodic leakage testing of the gas side with appropriate fluid/inert gas to be conducted. 2. Leakage detection and interlock with sight glass at low point of exhaust gas circuit with level switch LSHH-1003 3. Flammable gas detector AE-2001 at the exhaust gas outlet of 020E03 Feed Gas Final Preheater will initiate alarm and shutdown (H, HH) 4. Temperature monitoring TI-2006 at the exhaust gas outlet of 020E03 Feed Gas Final Preheater will initiate alarm and shutdown (H, HH, L)	Asset	3	B	Moderate	20. Proper maintenance and inspection procedures are to be developed for the system and equipment. <b>Status:</b> In Progress  35. Consider providing additional instrumentation for detection of gas leakage due to tubes failure, pinhole or large leaks at 012V01 Molten Salt Separator, 012V02 Molten Salt Collection Tank, 012E03 Feed Gas Final Preheater (e.g., hydrogen and hydrocarbon detection) <b>Status:</b> Resolved
			2. Fire/explosion inside exhaust gas piping		Asset	3	B	Moderate	
3.6	Solidification inside Molten Salt Collection Tank (012V02)	1. System Shutdown (process, emergency, controlled)	1. Solidification of metals inside Molten Salt Collection Tank (012V02)	1. Vessel is designed to handle liquid to solid, solid to liquid phase. 2. Exhaust gas circuit inside and start-up circuit with N <sub>2</sub> will liquify materials inside Molten Salt Collection Tank (012V02)	Asset	3	B	Moderate	36. All equipment in the system may have solidification issues. RAM study is to be conducted to address solidification issues. <b>Status:</b> In Progress
3.7	Inability to drain Molten Salt Collection Tank (012V02)	1. System Shutdown during maintenance and inspection	1. Inability to drain Molten Salt Collection Tank (012V02) for inspection, maintenance or repair		Asset	3	D	High	26. Study the need for draining the Reactor and Molten Salt Collection Tank (012V02) and other equipment or piping where solidification is a possibility due to leakage, other emergencies, or regular maintenance. Consider maintenance to be done in a marine environment. <b>Status:</b> Resolved

No.: 3		TCD System - Molten Salt Separator (012V01) and Molten Salt Collection Tank (012V02)							
Item	Deviation	Causes	Consequences	Safeguards	Matrix	S	L	R	Action Items
3.8	Level inside Molten Salt Collection Tank (012V02)	1. High level inside Molten Salt Collection Tank 012V02 (in case of level transmitter LT-1201 failure) <b>Deviation/Cause:</b> High level	4. Liquid carryover to vent line of Molten Salt Collection Tank (012V02)	1. Level monitoring LIC-1201 at Molten salt Collection Tank (012V02) will initiate alarm and shutdown (H, HH, L, LL) 2. Pressure monitoring (PIC-1205) at Molten Salt Collection Tank (012V02) will initiate H alarm 3. Piping system and components are designed to the same pressure as the relief valve in upstream piping	Asset	3	D	High	38. Investigate possibility of molten salt and catalysts carryover from Molten Salt Collection Tank (012V02) to vent line with PV-1205 and HV-1210. Consequences are to be evaluated as they can lead to blockage of vent lines. <b>Status:</b> In Progress
			5. Blockage of pressure balancing line of Molten Salt Collection Tank (012V02)		Asset	2	D	High	
			6. Blockage of relief vent line, leading to high pressure in Molten Salt Collection Tank (012V02)		Asset	3	D	High	
			7. Tank damage		Asset	3	D	High	
		2. Low level inside Molten Salt Collection Tank 012V02 <b>Deviation/Cause:</b> Low level	1. Low level of molten salt and catalyst for the system (Molten Salt Collection Tank 012V02)	1. Level monitoring LIC-1201 at Molten salt Collection Tank (012V02) will initiate alarm and shutdown (H, HH, L, LL) 4. Monitoring of decomposition gas composition for system efficiency	Asset	2	C	Moderate	37. Add level L alarm to LT-1201 and LL interlock to monitor low level in 012V02 Collection Tank. Current design only has H and HH. <b>Status:</b> Resolved
			2. Not enough catalyst and salt to Reactor		Asset	2	C	Moderate	
			3. Decreased efficiency of the system		Asset	2	C	Moderate	

No.: 3		TCD System - Molten Salt Separator (012V01) and Molten Salt Collection Tank (012V02)							
Item	Deviation	Causes	Consequences	Safeguards	Matrix	S	L	R	Action Items
3.9	Temperature inside Molten Salt Collection Tank (012V02)	1. temperature sensor failure TE-1201 inside Molten Salt Collection Tank (012V02) <b>Deviation/Cause:</b> High Temperature	2. High temperature of molten salt and catalysts inside Molten Salt Collection Tank (012V02)	1. Multiple temperature sensors (TE-1002, TE-1002A, TE-1002B at Molten Salt Collector, and TE-1005 with H alarm and HH shutdown at reactor exhaust gas outlet) 2. System is designed for 900 degC	Asset	2	B	Low	
		2. Low temperature of exhaust gas (see 3.3) <b>Deviation/Cause:</b> Low Temperature	1. Solidification of catalyst and salt inside Molten Salt Collection Tank (012V02)	3. Multiple temperature sensors TE-1005 with L alarm, and TE-1201 with L alarm and LL shutdown at Molten Salt Collection Tank (012V02)	Asset	1	C	Low	
3.10	Pressure inside Molten Salt Collection Tank (012V02)	1. No issues with pressure in the tank. System is designed to pressure of relief valves of CH <sub>4</sub> supply pressure.							
3.11	Catalyst and Salt mixture in Molten Salt Collection Tank (012V02)	1. Salt and catalyst is not soluble at suction of the Molten Salt Collection Tank bottom, leading to catalyst in the bottom of tank	1. Molten Salt Recycle Pump (012P01) pumps too much catalyst from Molten Tank to Reactor, leading to Reactor full of catalyst	1. Pre-weighting of salt and catalyst	Asset	3	C	High	39. Rotoboost to further study the monitoring of quantity of catalyst and salt inside the Reactor and develop monitoring and control measures to manage appropriate salt and catalyst quantity inside the Reactor. <b>Status:</b> In Progress
			2. Too much catalyst in the system lead to lower quality carbon (higher beta yielding rate)		Asset	3	C	High	
			3. Too much catalyst in the Reactor leading to off-spec Decomposition Gas		Asset	3	C	High	

No.: 3		TCD System - Molten Salt Separator (012V01) and Molten Salt Collection Tank (012V02)							
Item	Deviation	Causes	Consequences	Safeguards	Matrix	S	L	R	Action Items
		2. Loss of catalyst and salt during operation is not known							40. From operational experience, data need to be collected on rate of catalyst loss to optimise the quantity and feed rate of catalyst and salt to Reactor <b>Status:</b> In Progress  41. Investigate any weight measurement of Reactor tubes can help determine the quantity of catalyst and salt in the system <b>Status:</b> In Progress

No.: 4		TCD System - Feed Gas Final Preheater							
Item	Deviation	Causes	Consequences	Safeguards	Matrix	S	L	R	Action Items
4.1	exhaust gas pressure and temperature	1. Exhaust gas temperature is higher than operating temperature <b>Deviation/Cause:</b> High Temperature	1. Degradation of materials of the Feed Gas Preheater	1. Temperature monitoring TI-1005 at the exhaust gas outlet of 010R01 Decomposition Reactor will initiate alarm and shutdown (H, HH, L)  5. Temperature monitoring TI-2006 at the exhaust gas outlet of 020E03 Feed Gas Final Preheater will initiate alarm and shutdown (H, HH, L)	Asset	3	B	Moderate	42. Consider adding another independent layer of protection temperature monitor (independent from TE-1005 at Reactor exhaust gas outlet) to monitor temperature in Exhaust Gas stream. <b>Status:</b> Resolved
			2. High temperature feed gas in the system		Asset	1	B	Low	
		3. Tubes failure in Final Preheater (decomposition gas side)	4. Natural Gas in exhaust gas stream (around 800 degC) stream in Final Preheater	3. Oxygen analyzer and control at exhaust gas outlet of Reactor (2.3% to 3.5%) 4. During Startup, leak testing of equipment, including Preheater and Final Preheater, is conducted.  6. Leakage detection and interlock with slight glass at low point of exhaust gas circuit with level switch LSHH-1003 7. Flammable gas detector AE-2001 at the exhaust gas outlet of 020E03 Feed Gas Final Preheater will initiate alarm and shutdown (H, HH)	Asset	3	B	Moderate	35. Consider providing additional instrumentation for detection of gas leakage due to tubes failure, pinhole or large leaks at 012V01 Molten Salt Separator, 012V02 Molten Salt Collection Tank, 012E03 Feed Gas Final Preheater (e.g., hydrogen and hydrocarbon detection) <b>Status:</b> Resolved
			5. Fire and explosion inside exhaust gas stream due to temperature above auto-ignition temperature and excess oxygen		Asset	3	B	Moderate	

No.: 5		TCD System - Carbon and Decomposition Gas Separation							
Item	Deviation	Causes	Consequences	Safeguards	Matrix	S	L	R	Action Items
5.1	Gas blowby	1. Low level in 020V03 Carbon Buffer Vessel	1. Potential gas blowby to Carbon Conveyor 020P01 when HV-2017 is open at the outlet of 020V03 carbon buffer vessel	1. Pressure control loop PIC-2007 on the N <sub>2</sub> injection line 2. Level monitoring switch LSSL-2004 at 020V03 Carbon Buffer Vessel will interlock with bottom valve HV-2017 and initiate shutdown (LL)	Asset	3	C	High	43. Review gas separation system and provide solution to prevent gas blowby to Carbon Conveyor 020P01. Evaluate ability to push carbon to Carbon Conveyor 020P01 and evaluate use of N <sub>2</sub> to push carbon. <b>Status:</b> Resolved 44. Consider adding low level alarm and shutdown at 020V03 Carbon Buffer Vessel to prevent gas blowby to the Carbon Conveyor 020P01. <b>Status:</b> Resolved 45. Review hydrogen/carbon separation system ability to push carbon from 20E01 Feed Gas Preheater and 020F01A/B Carbon Filters to 020V03 Carbon Buffer Vessel. <b>Status:</b> In Progress
			2. Fire/explosion		Asset	3	C	High	
5.2	Blocked flow	1. Flow restriction or blocked flow (i.e., inadvertent valve closure. Scenarios will be covered in detailed engineering phase.							

No.: 6		TCD System - GA inside Container							
Item	Deviation	Causes	Consequences	Safeguards	Matrix	S	L	R	Action Items
6.1	Temperature inside container (scenarios covered in 2.8)	1. Temperature inside container - TCD System - Feed Gas Decomposition Reactor (see 2.8)							
6.2	Exhaust gas Ventilation (see sections 20.1 and 20.2)	1. Vent mast for TCD system venting (product carrier and VLCC) - Vessel - Ventilation and Venting System (see 20.1) 2. Vent mast for TCD system venting (ferry) - Vessel - Ventilation and Venting System (see 20.2)							
6.3	Drainage and disposal from container	1. Materials leakage due to accident or during maintenance	1. Catalyst materials are environmental pollutants (per MSDS)		Environmental	2	C	Moderate	46. Detailed maintenance procedures, material storage and handling procedures, and disposal guidelines inside the container are to be developed. 47. Further study to verify catalyst life and mechanisms for degradation of catalyst and salt. <b>Status:</b> In Progress

No.: 7		TCD System - Venting System							
Item	Deviation	Causes	Consequences	Safeguards	Matrix	S	L	R	Action Items
7.1	Vent System detailed design for TCD system	1. No significant risk identified. Installation specific venting and hazardous area requirements are to be followed.							
7.2	Exhaust gas venting (see sections 20.1 and 20.2)	1. Exhaust gas venting (see 20.1)							48. Venting of the exhaust is to be decided based on installation specific requirements. <b>Status:</b> In Progress
		2. Exhaust gas venting (see 20.2)							48. Venting of exhaust gas is to be decided based on installation specific requirements. <b>Status:</b> In Progress



No.: 8		TCD System - Ventilation system										
Item	Deviation	Causes	Consequences	Safeguards	Matrix	S	L	R	Action Items			
8.1	Hydrogen leak	1. Mechanical damage (e.g., pipe failure, connection failure)	1. Hydrogen leakage inside container, leading to hazardous atmosphere inside container	1. Flammable gas detection inside container system (alarm at 20% LEL) 2. Fire detection inside container system 3. Container is designed as zone 1 classification 4. 2x100% fans circulating air in container 5. ESD triggered by fire and/or gas detection (shutdown at 40% LEL) to isolate the system 6. Firefighting system (CO <sub>2</sub> and fire extinguisher) 7. Water spray system to cool down outside surface of the container	Asset	3	B	Moderate	7. Conduct Gas Dispersion analysis and Fire & Explosion analysis to understand fire and explosion hazards. Provide appropriate mitigation measures for firefighting system. <b>Status:</b> In Progress 49. Provide water spray system on outside surface to keep container cool. <b>Status:</b> Resolved 50. Upon detection of hazard, interlink between FGSS and TCD container system has to be determined. <b>Status:</b> Resolved 51. For hydrocarbon and methane gas leak, air inlet to the container has to be from a safe area and outlet has to be located appropriately for installation specific requirements.			
			2. Fire and detonation inside container					Asset		4	B	High
			4. Solidification of catalyst and salt in the system (upon ESD) (see 3.3)									
			5. Solidification of catalyst and salt inside Reactor (see 2.10)									
8.2	Methane leak inside container	1. Methane leakage - TCD System - Feed gas, Gas Sweetening, Feed Gas Preheater (see 1.4)										

No.: 8		TCD System - Ventilation system							
Item	Deviation	Causes	Consequences	Safeguards	Matrix	S	L	R	Action Items
8.3	Exhaust gas leak	1. Mechanical damage (e.g., pipe failure, connection failure)	1. Exhaust gas leakage inside container, leading to hazardous space or toxic atmosphere for personnel (e.g., CO, CO <sub>2</sub> )	1. Fixed and portable oxygen detection inside container 2. Temperature trip inside container 3. Pressure monitoring in the exhaust gas system 4. Ventilation system (Continuous 30 air changes/hr) 5. Flammable gas detection inside container system (alarm at 20% LEL) 6. Flammable gas detectors with specifications to detect flammable gas and CO: AE-0001 & AE-0002 inside the containers, AE-0003 at ventilation outlet	Injury	3	B	Moderate	52. Consider providing toxic gas detection inside the container to detect any leakage from exhaust gas stream. <b>Status:</b> Resolved

No.: 9		TCD System - Chemicals							
Item	Deviation	Causes	Consequences	Safeguards	Matrix	S	L	R	Action Items
9.1	Catalysts disposal	1. Improper catalyst storage, handling, and disposal onboard	1. Potential environmental impact to marine environment	1. Firefighting system in TCD container and catalyst storage	Environmental	2	C	Moderate	53. Proper materials handling and disposal procedures are to be developed for catalysts and salt. 54. Develop firefighting procedures with consideration for bismuths in catalyst. <b>Status:</b> In Progress 55. Proper PPE are to be provided to safely handle catalysts and salts. <b>Status:</b> In Progress
			2. Fire (due to bismuth flammability)		Asset	3	C	High	
			3. Personnel exposure to bismuth combustion product (not a toxic concern, just flammable)		Injury	2	C	Moderate	

No.: 10		TCD System - Container Safety System							
Item	Deviation	Causes	Consequences	Safeguards	Matrix	S	L	R	Action Items
10.1	See section 21 Vessel - Safety Systems	1. Active firefighting (for VLCC and product carrier) - Vessel - Safety Systems (F&G Detection, Active & Passive Firefighting, etc.) (see 21.1) 2. Active firefighting (for ferry) - Vessel - Safety Systems (F&G Detection, Active & Passive Firefighting, etc.) (see 21.2)							

No.: 11		TCD System - Maintenance Operations							
Item	Deviation	Causes	Consequences	Safeguards	Matrix	S	L	R	Action Items
11.1	Maintenance activities	1. Changing of Absorber materials and filters inside the container (space constraint)	1. Unable to change Absorber materials due to compactness of the unit		Asset	3	C	High	46. Detailed maintenance procedures, material storage and handling procedures, and disposal guidelines inside the container are to be developed. 56. Conduct detailed RAM study at a later detailed engineering stage and incorporate results in the maintenance procedures. <b>Status:</b> In Progress
		2. Maintenance activities in any equipment and piping	7. Exposure to catalysts to oxygen during maintenance activities, leading to bismuth fire		Overall	S3-Moderate	LC-Possible	High	56. Conduct detailed RAM study at a later detailed engineering stage and incorporate results in the maintenance procedures. <b>Status:</b> In Progress 60. Study the potential catalyst (bismuth) exposure to oxygen during maintenance activities and develop proper procedures to minimise the risk. <b>Status:</b> In Progress
		3. Material degradation of Reactor tubes or inside piping	2. Tubes failure inside Reactor	1. Temperature monitoring of Reactor including H alarm and HH shutdown of system 2. Oxygen analyzer to detect excess air in exhaust gas stream from Reactor 3. Visual indicators including black smoke in vent mast (incomplete combustion)	Asset	3	C	High	15. Add H alarm and HH shutdown and appropriate setpoints to LEL-1001 flammable gas detector in exhaust gas outlet of Reactor. <b>Status:</b> Resolved

No.: 11		TCD System - Maintenance Operations								
Item	Deviation	Causes	Consequences	Safeguards	Matrix	S	L	R	Action Items	
				4. Pump monitoring, part of routine inspection procedures, of 012P01 Molten Salt Recycle Pump will alert operator on more frequent pumping or pump overload 5. Flammable Gas Detector AI-1001 at the exhaust gas outlet of 010R01 Decomposition Reactor will initiate alarm and shutdown (H, HH) 6. ESD will be initiated by the system 7. Oxygen Content monitoring: OIC-1001 oxygen analyzer will initiate alarm and shutdown (H, HH, L, LL) and interlock with Burner management system 8. Leakage detection and interlock with sight glass at low point of exhaust gas circuit with level switch LSHH-1003 9. Temperature monitoring TI-2006 at the exhaust gas outlet of 020E03 Feed Gas Final Preheater will initiate alarm and shutdown (H, HH, L)						35. Consider providing additional instrumentation for detection of gas leakage due to tubes failure, pinhole or large leaks at 012V01 Molten Salt Separator, 012V02 Molten Salt Collection Tank, 012E03 Feed Gas Final Preheater (e.g., hydrogen and hydrocarbon detection) <b>Status:</b> Resolved 56. Conduct detailed RAM study at a later detailed engineering stage and incorporate results in the maintenance procedures. <b>Status:</b> In Progress 57. Develop detailed inspection procedures for the lifetime of the system, including appropriate replacement schedule for equipment (i.e., annually) <b>Status:</b> In Progress 58. System has to be designed such that it can detect salt or catalyst leakage to exhaust gas circuit of the system <b>Status:</b> Resolved 59. Study proper materials and design selection of tubes in the Reactor, with consideration for Reactor operating in hydrogen rich environment at high temperature and direct flame exposure. <b>Status:</b> In Progress
			3. Leading to decomposition gas or CH <sub>4</sub> in the exhaust gas side of the Reactor		Asset	2	C	Moderate		

No.: 11		TCD System - Maintenance Operations							
Item	Deviation	Causes	Consequences	Safeguards	Matrix	S	L	R	Action Items
			4. Leading to Salt or catalyst in exhaust gas side of the Reactor		Asset	3	C	High	
			5. Leading to more demand for salt to Reactor, leading to more frequent pumping, causing pump overload at 012P01 Molten Salt Recycle Pump		Asset	3	B	Moderate	
			6. Accumulation of salt or catalyst in the exhaust gas stream leading to blockage inside Reactor or exhaust gas stream		Asset	3	C	High	

<b>No.:</b> 12		Vessel - General Arrangement - Bunkering							
<b>Item</b>	<b>Deviation</b>	<b>Causes</b>	<b>Consequences</b>	<b>Safeguards</b>	<b>Matrix</b>	<b>S</b>	<b>L</b>	<b>R</b>	<b>Action Items</b>
12.1	No issues identified. Proposed vessel (chemical carrier, VLCC, ferry) is in compliance with IGF code.	1. No issues identified. Proposed vessel (chemical carrier, VLCC, ferry) is in compliance with IGF code.							



No.: 13		Vessel - General Arrangement - Fuel Storage							
Item	Deviation	Causes	Consequences	Safeguards	Matrix	S	L	R	Action Items
13.1	No issues identified. Proposed vessel (chemical carrier, VLCC, ferry) is in compliance with IGF code.	1. No issues identified. Proposed vessel (chemical carrier, VLCC, ferry) is in compliance with IGF code.							

No.: 14		Vessel - General Arrangement							
Item	Deviation	Causes	Consequences	Safeguards	Matrix	S	L	R	Action Items
14.1	TCD system installation location on product carrier and VLCC	1. High temperature exhaust venting in hazardous area ( ~600 degC)	1. Ignition of LNG vent mast	1. H <sub>2</sub> vent will run with LNG vent	Asset	2	C	Moderate	<p>61. Detailed study are to be developed for the product carrier, and dispersion analysis to be conducted to see if exhaust ventilation and LNG/H<sub>2</sub>/product ventilation are not interfering to create explosion and fire hazards. <b>Status:</b> In Progress</p> <p>62. Determine the type of insulation/cladding and effectiveness for exhaust vent piping to manage surface temperature below auto-ignition temperature and stay in tack (not breaking apart). <b>Status:</b> In Progress</p> <p>64. Keep TCD vent mast separate and as far as possible from other vent masts. <b>Status:</b> In Progress</p> <p>65. Investigate if TCD system has to shut down during cargo loading/unloading operation. Also consider the port operations restrictions and owner operation procedures. <b>Status:</b> In Progress</p> <p>66. If ship owner and regulations do not allow LNG in the port, consider adding another fuel (diesel) to run TCD system during port operations. <b>Status:</b> In Progress</p>

No.: 14		Vessel - General Arrangement							
Item	Deviation	Causes	Consequences	Safeguards	Matrix	S	L	R	Action Items
									67. Consider proper insulation, cladding for the exhaust piping to minimise the temperature to below the auto-ignition temperature of hydrocarbon or other products. <b>Status:</b> In Progress 68. Vent stack for H <sub>2</sub> to be designed to withstand pressure higher than 25 bar (in case of detonation, the maximum pressure generated is 25 bar) <b>Status:</b> Resolved 69. Further studies are to be done to check regulation restrictions for putting fire equipment on the deck with respect to SOLAS and IGF. <b>Status:</b> In Progress
			2. Ignition of H <sub>2</sub> Vent mast		Asset	3	C	High	
			3. Ignition of product carrier or VLCC vent mast (possibility to contain hydrocarbon)		Asset	2	C	Moderate	
			4. Flashback/explosion in vent mast (H <sub>2</sub> only, worst case is piping can bend)		Asset	2	C	Moderate	
			5. Exhaust vent piping at high temperature above auto-ignition temperature, leading to fire		Asset	3	C	High	

No.: 14		Vessel - General Arrangement							
Item	Deviation	Causes	Consequences	Safeguards	Matrix	S	L	R	Action Items
		2. cargo piping underneath TCD system container	6. Confined space underneath the TCD leading to potential fire/explosion underneath TCD system container		Asset	4	B	High	7. Conduct Gas Dispersion analysis and Fire & Explosion analysis to understand fire and explosion hazards. Provide appropriate mitigation measures for firefighting system. <b>Status:</b> In Progress 63. Consider the cargo piping routes and study the risks due to installation of TCD system container to find a safe space to install the TCD system <b>Status:</b> In Progress 65. Investigate if TCD system has to shut down during cargo loading/unloading operation. Also consider the port operations restrictions and owner operation procedures. <b>Status:</b> In Progress 66. If ship owner and regulations do not allow LNG in the port, consider adding another fuel (diesel) to run TCD system during port operations. <b>Status:</b> In Progress
			7. Damage to cargo tanks in product carrier or VLCC		Asset	4	B	High	

No.: 14		Vessel - General Arrangement							
Item	Deviation	Causes	Consequences	Safeguards	Matrix	S	L	R	Action Items
14.2	TCD system installation location on ferry	1. Hydrogen or CH <sub>4</sub> leak in TCD room located in hull space on ferry	1. Hazardous atmosphere inside TCD space	1. Area is classified as zone 1 2. Ventilation system (30 air changes/hr) 3. Fire and Gas Detection 4. TCD system ESD 5. TCD space is fire rated to A-60	Asset	2	D	High	70. Consider installing equipment inside a separate room with proper relief hatch venting to the upper deck of the ferry. If there is more than two TCD systems, install them in the same space. <b>Status:</b> In Progress 71. Conduct fire & explosion and gas dispersion studies for TCD space and fuel space to ensure that damage is limited inside the TCD space and/or room and overpressure is properly relieved. <b>Status:</b> In Progress 72. Proper study have to be conducted considering surrounding space and equipment inside the space, to comply with SOLAS and other regulation requirements. <b>Status:</b> In Progress 73. Detailed CFD analysis and ventilation study are to be conducted to manage the temperature within the acceptable limit, considering the electrical equipment rating and human perspective. <b>Status:</b> In Progress 74. Consider separating TCD space from other vessel category A machinery space <b>Status:</b> In Progress
			2. Fire/explosion inside TCD space		Asset	3	C	High	

No.: 14		Vessel - General Arrangement							
Item	Deviation	Causes	Consequences	Safeguards	Matrix	S	L	R	Action Items
			3. Damage to TCD space		Asset	3	C	High	
			4. Damage to ferry fuel space		Asset	4	B	High	
			5. Damage to engine room partition walls on ferry		Asset	4	B	High	
14.3	Catalyst and salt storage (for VLCC, product carrier, and ferry)	1. High humidity in bismuth storage space	1. Bismuth fire (byproduct is bismuth oxide on surface and rapid oxidation after gas point, not toxic)	1. Bismuth is always delivered in a closed container 2. Bismuth fire combustion product is not toxic	Overall	S3-Moderate	LC-Possible	High	46. Detailed maintenance procedures, material storage and handling procedures, and disposal guidelines inside the container are to be developed.  75. Any other products stored in the same space are to be looked at from hazards perspective and fire consequences <b>Status:</b> In Progress  76. In case of fire involving bismuth, conduct study to find appropriate firefighting measures, e.g. water mist, foam, dry powder. <b>Status:</b> In Progress
		2. Fire in other surrounding stored materials	2. Impact on bismuth container integrity, leading to bismuth fire	1. Bismuth is always delivered in a closed container 2. Bismuth fire combustion product is not toxic	Overall	S3-Moderate	LC-Possible	High	75. Any other products stored in the same space are to be looked at from hazards perspective and fire consequences <b>Status:</b> In Progress  76. In case of fire involving bismuth, conduct study to find appropriate firefighting measures, e.g., water mist, foam, dry powder. <b>Status:</b> In Progress

No.: 14		Vessel - General Arrangement							
Item	Deviation	Causes	Consequences	Safeguards	Matrix	S	L	R	Action Items
		3. Changing of Absorber materials and filters inside the container (space constraint)							46. Detailed maintenance procedures, material storage and handling procedures, and disposal guidelines inside the container are to be developed.
14.4	Buffer tank on deck (for low pressure system on VLCC)	1. External fire	1. Pressure increase in buffer tank, leading to buffer tank damage	1. Blowdown Valves (trigger by ESD or backpressure) on buffer tank will open to relief pressure 2. Pressure Safety Valves on buffer tank will open to relief pressure 3. Water Spray System to cool down Type C Buffer Tank	Asset	3	C	High	77. IGF code requires deluge and blowdown systems in case of fire. <b>Status:</b> In Progress 78. Since buffer tank will be a Type C tank, IGF code requires water spray system to keep the tank cool. <b>Status:</b> Resolved 79. Since buffer tank will be a Type C tank, design needs to meet IGF code requirements. <b>Status:</b> In Progress
			2. Buffer tank explosion		Asset	3	C	High	
14.5	Fire equipment on deck (VLCC and product carrier)	1. Hazardous atmosphere on deck	1. Fire and explosion due to fire equipment in TCD system	1. TCD equipment is inside container with A-60 fire rated walls 2. TCD has its own ventilation system (30 air changes/hr) 3. Fire and Gas Detection inside the TCD system 4. Hot surfaces are insulated inside TCD 5. Flammable gas and CO detector AE-0006 installed at the entrance door of each container will initiate alarm and shutdown (H, HH)	Overall	S4-Major	LB-Unlikely	High	80. For VLCC, all cargo tank venting or any hazardous area vent on the weather deck, are to be studied with respect to location of TCD container, and maximum separations are to be provided due to high temperature equipment above the operating auto-ignition temperatures. <b>Status:</b> In Progress 81. Consider adding gas detector outside of container entrance door at appropriate locations to detect gas leak. <b>Status:</b> Resolved

No.: 14		Vessel - General Arrangement							
Item	Deviation	Causes	Consequences	Safeguards	Matrix	S	L	R	Action Items
				6. Flammable gas and CO detector AE-0004 & AE-0005 installed at the ventilation inlet of container will initiate alarm and shutdown (H, HH)					82. Consider installing gas detectors at the ventilation inlet to TCD system. <b>Status:</b> Resolved
		2. High temperature of exhaust mast (see 14.1)							
14.6	Carbon storage in VLCC or product carrier (common issues)	1. Low humidity conditions in during transferring operations	1. Fire and explosion inside carbon storage container	2. at 45% humidity there is low risk of fire 3. Exterior water spray to cool down surface of carbon storage container	Asset	3	B	Moderate	87. Humidity needs to be monitored continuously to prevent fire due to carbon black. Consider initiate water spray system to increase humidity. <b>Status:</b> In Progress 88. Study external fire impact on carbon storage container and provide appropriate prevention and mitigation measures. <b>Status:</b> Resolved 89. Conduct further study and analysis on the carbon transfer system from the TCD system to the storage container or storage tank, considering impact due to ship motions, weather, etc. and impact of spillage. <b>Status:</b> In Progress
		2. Low salt% in carbon storage (salt is used to "wet" carbon to keep it in stable conditions and prevent dust)	1. Fire and explosion inside carbon storage container		Asset	3	B	Moderate	86. Investigate minimum salt % to keep carbon "wet" and appropriate salt type selection for carbon storage container. <b>Status:</b> In Progress



No.: 14		Vessel - General Arrangement							
Item	Deviation	Causes	Consequences	Safeguards	Matrix	S	L	R	Action Items
		3. Carbon dust buildup inside carbon storage during normal operations	1. Fire and explosion inside carbon storage container	1. Closed conveyor belt system, including carbon storage, will drop carbon to storage container (minimal operator intervention)	Asset	3	B	Moderate	84. Investigate if water spray system is appropriate for carbon black handling to avoid dust formation. If water spray is used to prevent carbon dust, consider developing detailed procedures and system requirements. <b>Status:</b> In Progress 86. Investigate minimum salt % to keep carbon "wet" and appropriate salt type selection for carbon storage container. <b>Status:</b> In Progress 89. Conduct further study and analysis on the carbon transfer system from the TCD system to the storage container or storage tank, considering impact due to ship motions, weather, etc. and impact of spillage. <b>Status:</b> In Progress
			2. Spillage of carbon onto deck from carbon storage container during operation		Environmental	2	B	Low	
		4. Mishandling of carbon black during operations (wind, wave, rain)	2. Spillage of carbon onto deck from carbon storage container during operation	1. Closed conveyor belt system, including carbon storage, will drop carbon to storage container (minimal operator intervention)	Environmental	2	B	Low	83. Provide appropriate drip trays to collect carbon spillage on deck and develop proper disposal procedures. <b>Status:</b> In Progress

No.: 14		Vessel - General Arrangement							
Item	Deviation	Causes	Consequences	Safeguards	Matrix	S	L	R	Action Items
									84. Investigate if water spray system is appropriate for carbon black handling to avoid dust formation. If water spray is used to prevent carbon dust, consider developing detailed procedures and system requirements. <b>Status:</b> In Progress 85. IMDG cargo classifications and packaging requirements are to be studied for the carbon storage container. <b>Status:</b> In Progress 89. Conduct further study and analysis on the carbon transfer system from the TCD system to the storage container or storage tank, considering impact due to ship motions, weather, etc. and impact of spillage. <b>Status:</b> In Progress
			3. Environmental impact due to carbon black in marine environment		Environmental	2	C	Moderate	
14.7	Carbon storage in VLCC or product carrier void space surrounding engine room (common issues)	1. Carbon storage (for product carrier and VLCC). Issues identified in section 14.5 still apply. (see 14.6)							

No.: 14		Vessel - General Arrangement							
Item	Deviation	Causes	Consequences	Safeguards	Matrix	S	L	R	Action Items
		2. Carbon dust buildup in storage tank	1. Fire and explosion near engine room and accommodations	1. Area is classified per regulatory requirements	Overall	S3-Moderate	LC-Possible	High	90. When carbon storage is in VLCC void space surrounding engine room or accommodations, investigate the probability of explosion due to carbon dust and provide appropriate prevention and mitigation measures. <b>Status:</b> In Progress
		3. Carbon density is higher than oil storage (plan to store carbon in void fuel storage spaces of VLCC)	2. Structural strength and stability issues, leading to vessel maneuverability issues		Overall	S2-Minor	LC-Possible	Moderate	91. Study if void space is available in Ro-Pax vessel for TCD system. <b>Status:</b> In Progress 92. When carbon quantity is large, the carbon storage will be in a tank or inside a hull, which may impact vessel strength and stability. Vessel strength and stability has to be reevaluated to comply with vessel class rules. <b>Status:</b> In Progress 93. Conduct risk evaluations to prevent any fire or explosion inside the tank when carbon is stored inside the hull or inside tanks or oil tanks of a vessel. <b>Status:</b> In Progress
14.8	Carbon storage and general arrangements on VLCC (specific to VLCC)	1. Volume of carbon produced is too large for long voyage	1. Not enough storage space for carbon black storage on VLCC		Asset	3	C	High	94. Conduct study on carbon production and storage on VLCC or investigate partitioning of VLCC cargo void tank to make carbon storage possible for long voyage. <b>Status:</b> In Progress

No.: 14		Vessel - General Arrangement							
Item	Deviation	Causes	Consequences	Safeguards	Matrix	S	L	R	Action Items
		2. Collection of carbon from 3 TCD containers on VLCC during long voyage							95. Further design development are to be done to investigate how to collect carbon from individual TCD containers and stored in storage space. <b>Status:</b> In Progress
		3. Overloading of VLCC deck with three TCD containers	2. Structural damage to VLCC deck		Asset	3	C	High	96. Conduct structural analysis with TCD and carbon containers on VLCC deck. <b>Status:</b> In Progress 97. Investigate gaps between TCD container and weather deck to avoid any confined space. <b>Status:</b> In Progress 98. Placement of TCD and carbon containers on VLCC are to be investigated. <b>Status:</b> In Progress
14.9	TCD space inside fuel room of ferry	1. CH <sub>4</sub> or decomposition gas leak inside TCD space	1. Hazardous atmosphere inside TCD space	1. H <sub>2</sub> detectors and decomposition gas detectors (see safeguards in node 1 & 2) 2. Area is classified as zone 1 3. Ventilation system ( 30 air changes/hr) 4. Fire and Gas Detection 5. TCD system ESD 6. TCD space is fire rated to A-60	Asset	2	D	High	10. Conduct study for where the explosion gases will go from pressure relief panel from TCD container top to relieve pressure from container. <b>Status:</b> In Progress 70. Consider installing equipment inside a separate room with proper relief hatch venting to the upper deck of the ferry. If there is more than two TCD systems, install them in the same space. <b>Status:</b> In Progress

No.: 14		Vessel - General Arrangement							
Item	Deviation	Causes	Consequences	Safeguards	Matrix	S	L	R	Action Items
									<p>71. Conduct fire &amp; explosion and gas dispersion studies for TCD space and fuel space to ensure that damage is limited inside the TCD space and/or room and overpressure is properly relieved.  <b>Status:</b> In Progress</p> <p>72. Proper study needs to be conducted considering surrounding space and equipment inside the space, to comply with SOLAS and other regulation requirements.  <b>Status:</b> In Progress</p> <p>73. Detailed CFD analysis and ventilation study are to be conducted to manage the temperature within the acceptable limit, considering the electrical equipment rating and human perspective.  <b>Status:</b> In Progress</p> <p>74. Consider separating TCD space from other vessel category A machinery space  <b>Status:</b> In Progress</p> <p>99. TCD equipment to be installed inside separate room by subdividing fuel space on ferry and provide separate explosion relief and ducting to safe space above weather deck.  <b>Status:</b> In Progress</p>

No.: 14		Vessel - General Arrangement							
Item	Deviation	Causes	Consequences	Safeguards	Matrix	S	L	R	Action Items
									100. Investigate regulatory restrictions applicable to TCD system arrangements on ferry or investigate if coffer dam is required for engine and TCD space on ferry. <b>Status:</b> In Progress 101. Conduct carbon explosion study to estimate the blast pressure and mitigation pressures are to be provided so structure can withstand blast load. <b>Status:</b> In Progress 102. Consider double wall pipe for fuel space (not inside TCD container) <b>Status:</b> In Progress 103. EER study to be conducted for the TCD space <b>Status:</b> In Progress 104. Provide air locks for entry to TCD space and two means of escape routes or hatches from TCD space inside fuel room of ferry to vessel lifeboat. <b>Status:</b> In Progress 105. TCD space will require air inlet, ventilation outlet, and exhaust gas outlet, ducting placements and separation requirements are to be considered. <b>Status:</b> In Progress
			2. Fire/explosion inside TCD space		Asset	3	C	High	
			3. Damage to TCD space		Asset	3	C	High	

No.: 14		Vessel - General Arrangement							
Item	Deviation	Causes	Consequences	Safeguards	Matrix	S	L	R	Action Items
			4. Damage to ferry fuel space		Asset	4	B	High	
			5. Damage to engine room partition walls on ferry		Asset	4	B	High	
		2. Carbon storage inside TCD space							106. Further study to be done on carbon storage, carbon conveying, and utilizing empty spaces. <b>Status:</b> In Progress 107. To remove carbon will require continuous entry into hazardous space and needs to be investigated further. <b>Status:</b> In Progress 108. Investigate if continuous carbon convey system is installed and what is the impact on hazardous zone extension. <b>Status:</b> In Progress

No.: 15		Vessel - Fuel Gas Supply System (FGSS) for Engine and TCD							
Item	Deviation	Causes	Consequences	Safeguards	Matrix	S	L	R	Action Items
15.1	Supply pressure to FGSS 4-stroke engine	1. Low supply pressure to FGSS. No significant issues due to dedicated compressor. <b>Deviation/Cause:</b> Low Pressure							
		2. High supply pressure to FGSS. No significant issues due to dedicated compressor and recycling line at the compressor. <b>Deviation/Cause:</b> High Pressure							
15.2	Supply pressure to FGSS 2-stroke engine	1. Low supply pressure to FGSS 2-stroke engine from TCD. No significant issues due to dedicated compressor.							111. For LP system, determine appropriate compressor type and conduct vibration analysis for the entire system if needed (from equipment and moving vessel) in the design. Provide appropriate pressure compensating method in the discharge piping and sealing system per compressor manufacturer recommendation. <b>Status:</b> Resolved
		2. High supply pressure to FGSS 2-stroke engine from TCD. No significant issues due to dedicated compressor and recycling line at the compressor.							109. For hydrogen piping system, connection flange requirements are to be studied with respect to class and IGF codes. <b>Status:</b> In Progress 110. For HP compressor, venting system for compressor seals are to be designed per IGF and class requirements. <b>Status:</b> In Progress



No.: 15		Vessel - Fuel Gas Supply System (FGSS) for Engine and TCD							
Item	Deviation	Causes	Consequences	Safeguards	Matrix	S	L	R	Action Items
									112. For HP system, conduct vibration analysis (from equipment and moving vessel) for the entire system and incorporate in the design and provide appropriate pressure compensating method in the discharge piping. <b>Status:</b> Resolved
15.3	Incoming pressure from FGSS to TCD system (4-stroke and 2-stroke engines)	1. Lower receiving pressure from FGSS to TCD system than operating limit	1. TCD system cannot deliver defined hydrogen quantity due to higher receiving pressure	1. Compressor minimum recycle line to control compressor pressures (bypass arrangement to maintain suction pressure)	Asset	2	C	Moderate	113. Develop integration plan and specifications for inlet pressures of FGSS and proper control system are to be provided to ensure operating conditions (pressure, flow rate) from FGSS to TCD system are within specific limit. <b>Status:</b> In Progress
		2. Higher receiving pressure from FGSS to TCD system than operating limit	2. Higher flow rate from FGSS leading to more NG to DG, leading to decreased system efficiency	2. Pressure and flow monitoring in TCD system	Asset	2	C	Moderate	113. Develop integration plan and specifications for inlet pressures of FGSS and proper control system are to be provided to ensure operating conditions (pressure, flow rate) from FGSS to TCD system are within specific limit. <b>Status:</b> In Progress
15.4	Temperature at inlet of TCD system	1. High or low temperature gas from FGSS to TCD system	1. Damage to piping and equipment due to gas temperature outside operating limit	1. Temperature monitoring at inlet of TCD system include alarm and shutdown 2. Temperature monitoring from LNG Vapouriser, which will alert TCD control system and ESD system	Asset	2	C	Moderate	114. Conduct transient analysis from the initiation of temperature shutdown to see the temperature distribution in the piping <b>Status:</b> In Progress

No.: 15		Vessel - Fuel Gas Supply System (FGSS) for Engine and TCD							
Item	Deviation	Causes	Consequences	Safeguards	Matrix	S	L	R	Action Items
									115. Add temperature monitoring to LNG vapouriser including temperature alarm and shutdown, and interlock with TCD system inlet valves shutdown. <b>Status:</b> Resolved
15.5	Temperature from TCD system to FGSS	1. High or low temperature gas from TCD system to FGSS (before GVU)							116. Conduct temperature analysis from TCD system to FGSS system (before GVU) and provide appropriate operating temperature in detailed engineering phase. <b>Status:</b> In Progress

<b>No.: 16</b>		Vessel - Fuel Tank Connection							
<b>Item</b>	<b>Deviation</b>	<b>Causes</b>	<b>Consequences</b>	<b>Safeguards</b>	<b>Matrix</b>	<b>S</b>	<b>L</b>	<b>R</b>	<b>Action Items</b>
16.1	No significant issue identified. There is no direct link from TCD to fuel tank connection space.								

<b>No.:</b> 17		Vessel - Boil-off Gas Handling/Return							
<b>Item</b>	<b>Deviation</b>	<b>Causes</b>	<b>Consequences</b>	<b>Safeguards</b>	<b>Matrix</b>	<b>S</b>	<b>L</b>	<b>R</b>	<b>Action Items</b>
17.1	No significant issue identified.								

No.: 18		Vessel - Engine Room Arrangement/ Fuel supply from FGSS/TCD to Engine room							
Item	Deviation	Causes	Consequences	Safeguards	Matrix	S	L	R	Action Items
18.1	Leakage of H <sub>2</sub> and CH <sub>4</sub> mixture	1. Mechanical failure (i.e., piping)	1. Fire and Explosion in engine room (H <sub>2</sub> flammability limit is 4-75% and explosion limit is 20-60%, and CH <sub>4</sub> flammability limit is 5.3% - 17%)	1. Engine room piping is double walled (per IGF code requirements) 2. CH <sub>4</sub> and H <sub>2</sub> detectors inside engine room, initiate alarm and shutdown 3. ESD system for fuel supply after confirmed HH shutdown logic from F&G detection system 4. Engine Room arrangements and safety systems will meet IGF code requirements	Asset	3	B	Moderate	71. Conduct fire & explosion and gas dispersion studies for TCD space and fuel space to ensure that damage is limited inside the TCD space and/or room and overpressure is properly relieved. <b>Status:</b> In Progress

No.: 19		Vessel - Engine/Consumer							
Item	Deviation	Causes	Consequences	Safeguards	Matrix	S	L	R	Action Items
19.1	decomposition gas pressure and temperature	1. High temperature in engine	1. H <sub>2</sub> attack (Materials degradation)		Asset	3	C	High	117. Engine manufacturer has to type test engine and engine materials at selected fuel mixture for H <sub>2</sub> application. <b>Status:</b> In Progress
			2. Damage to engine components		Asset	4	C	Extreme	
		2. Engine performance/output due to % variation of decomposition gas and CH <sub>4</sub>	3. Lower engine output		Asset	2	C	Moderate	118. Engine manufacturer and Rotoboost has to develop monitoring system (i.e., engine RPM monitoring) for fuel mixture to optimise engine output, due to % variation of composition gas and CH <sub>4</sub> . Monitoring system has to be considered in the design of FGSS and TCD system. <b>Status:</b> In Progress
			3. Higher temperature of decomposition gas (fuel mixture temperature is designed to be below 50 degC, within engine specifications)		4. Sealing system issues	1. Temperature monitoring of TCD system including H alarm and HH shutdown of compressor	Asset	3	
	5. Higher stress on piping due to thermal expansion		Asset	3	B	Moderate			
19.2	Emissions (NOx)	1. No significant issue identified. Recommendations documented for further analysis per team discussion.							121. Verify NOx emissions from type testing of engine. Potential to increased NOx emissions from engine, due to higher temperature of combustion of H <sub>2</sub> . Optimise NOx emissions based on fuel mix and engine design. <b>Status:</b> In Progress

No.: 19		Vessel - Engine/Consumer							
Item	Deviation	Causes	Consequences	Safeguards	Matrix	S	L	R	Action Items
									122. During misfiring of 2-stroke engines, verify if the exhaust receiver and exhaust system are able to handle explosion pressure, i.e., H <sub>2</sub> explosion pressure is much higher than CH <sub>4</sub> . <b>Status:</b> In Progress  123. cross contamination of auxiliary systems need to be assessed for H <sub>2</sub> application. <b>Status:</b> In Progress

No.: 20		Vessel - Ventilation and Venting System							
Item	Deviation	Causes	Consequences	Safeguards	Matrix	S	L	R	Action Items
20.1	Vent mast for TCD system venting (product carrier and VLCC)	1. Vent mass for TCD venting (product carrier and ferry)							124. Vent mass design for TCD venting to be based on appropriate class rules and IGF requirements for the vent mass location and vent mast height. <b>Status:</b> In Progress 125. Consider locating vent mast with FGSS system vent mast of the vessel. <b>Status:</b> In Progress
20.2	Vent mast for TCD system venting (ferry)	1. Vent mass for TCD venting (ferry)							124. Vent mass design for TCD venting to be based on appropriate class rules and IGF requirements for the vent mass location and vent mast height. <b>Status:</b> In Progress 125. Consider locating vent mast with FGSS system vent mast of the vessel. <b>Status:</b> In Progress 126. Vent mass are to be located away from exhaust vent to avoid any recirculation or overlap of hazardous areas. <b>Status:</b> In Progress
20.3	Ventilation for TCD system (installation specific issues for product carrier and VLCC)	1. Hydrocarbon vapour intake in ventilation system	1. Fire and explosion	1. Air inlet is located in a safe area per International Code of Safety for Ship Using Gases or Other Low-flashpoint Fuels (IGF Code) requirements, International Electrotechnical Commission (IEC) requirements, and classification rules 2. Flammable gas and CO detector AE-0006 installed at the entrance door of each container will initiate alarm and shutdown (H, HH)	Asset	3	B	Moderate	82. Consider installing gas detectors at the ventilation inlet to TCD system. <b>Status:</b> Resolved 127. Consider providing ESD upon inlet gas detection and closing of all the openings. <b>Status:</b> Resolved



No.: 20		Vessel - Ventilation and Venting System							
Item	Deviation	Causes	Consequences	Safeguards	Matrix	S	L	R	Action Items
				3. Flammable gas and CO detector AE-0004 & AE-0005 installed at the ventilation inlet of container will initiate alarm and shutdown (H, HH)					
		2. Exhaust location from ventilation system (see 14.1)							
20.4	Ventilation for TCD system (installation specific issues for ferry)	1. Hazardous area due to TCD system ventilation exhaust in ferry	1. In case of vent mast fire, exposure to ferry passengers		Injury	2	C	Moderate	128. Investigate vent mast exhaust locations for the ferry, consider passenger proximity and other safe area proximity. <b>Status:</b> In Progress
20.5	Vent mass arrangement for exhaust gas venting (product carrier and VLCC)	1. High temperature in exhaust gas venting (600 degC) (see 14.1)	1. Fire and explosion due to other hazardous areas and products		Asset	3	C	High	67. Consider proper insulation, cladding for the exhaust piping to minimise the temperature to below the auto-ignition temperature of hydrocarbon or other products. <b>Status:</b> In Progress  129. Proper study are to be conducted considering other vents and openings, and proper separations are to be provided. <b>Status:</b> In Progress  130. Consider adding sufficient distance between the other vent masts on vessel (product carrier or VLCC), or vent masts on FGSS system and the TCD system exhaust vent mast. <b>Status:</b> In Progress

No.: 20		Vessel - Ventilation and Venting System							
Item	Deviation	Causes	Consequences	Safeguards	Matrix	S	L	R	Action Items
		2. Other vents and hazardous areas nearby	1. Fire and explosion due to other hazardous areas and products		Asset	3	C	High	67. Consider proper insulation, cladding for the exhaust piping to minimise the temperature to below the auto-ignition temperature of hydrocarbon or other products. <b>Status:</b> In Progress 129. Proper study are to be conducted considering other vents and openings, and proper separations are to be provided. <b>Status:</b> In Progress 130. Consider adding sufficient distance between the other vent masts on vessel (product carrier or VLCC), or vent masts on FGSS system and the TCD system exhaust vent mast. <b>Status:</b> In Progress
20.6	Vent mass arrangement for exhaust gas venting (ferry)	1. High temperature of exhaust venting near engine exhaust (TCD exhaust itself is creating hazardous zone)	1. Fire and explosion	1. TCD system exhaust has to be separated appropriately, considering it is hazardous	Asset	3	C	High	131. Exhaust ventilation is to be designed such that the radiant heat will not interfere with ferry passenger exposure. <b>Status:</b> In Progress
			2. Exposure of ferry passengers to high temperature exhaust venting		Injury	2	C	Moderate	

No.: 21		Vessel - Safety Systems (F&G Detection, Active & Passive Firefighting, etc.)							
Item	Deviation	Causes	Consequences	Safeguards	Matrix	S	L	R	Action Items
21.1	Active firefighting (for VLCC and product carrier)	1. Mechanical failure inside TCD system container	1. H <sub>2</sub> or CH <sub>4</sub> leak	1. CH <sub>4</sub> and H <sub>2</sub> gas detectors inside TCD system container initiate alarm and shutdown 2. Flame detectors inside TCD system container initiate alarm and shutdown 3. ESD of TCD system 4. Valves designed to be in fail safe mode (i.e., fails open or fails closed valves) 5. Active firefighting system includes CO <sub>2</sub> system to cool down TCD system container surface 6. Blowout hatch to relieve explosion pressure inside TCD system container 7. Ventilation system inside TCD system container (30 air changes/hr) 8. Space is classified as Zone 1 hazardous area classification 12. Vessel engine is dual fuel 15. Container wall is A-60	Asset	3	C	High	132. IGF code requires thermal relief to be provided in case of fire for any trapped fluids. Alternatively, this can be justified via risk assessment considering gaseous inventories. <b>Status:</b> Resolved
			2. Explosion		Asset	3	C	High	
			4. Fire		Asset	3	C	High	
			7. Unavailability of FGSS and TCD system		Asset	2	C	Moderate	
		2. External fire (due to fire in VLCC tank, product carrier tank, or LNG storage tank)	3. High heat radiation on TCD system container leading to temperature increase inside container	9. Water spray system on TCD container surface 10. Vessel fire & gas detection system in the area (independent from TCD fire & gas detection system) 11. Temperature monitoring on TCD container surface will trigger system shutdown	Asset	2	B	Low	133. Investigate interface between Vessel fire & gas detection system and TCD control and detection systems in case of external fire impacting TCD system. Proper protocols to be established. <b>Status:</b> In Progress

No.: 21		Vessel - Safety Systems (F&G Detection, Active & Passive Firefighting, etc.)							
Item	Deviation	Causes	Consequences	Safeguards	Matrix	S	L	R	Action Items
				12. Vessel engine is dual fuel 15. Container wall is A-60					134. Per IGF code, in case of vent mast fire, consider fire extinguishing system and drain connection in case of water accumulation in the bottom. <b>Status:</b> In Progress
			5. Vent mast fire due to TCD system ESD discharging hydrogen		Asset	2	C	Moderate	
			7. Unavailability of FGSS and TCD system		Asset	2	C	Moderate	
		3. Electrical fire inside TCD system container (Molten salt recycle pump (012P01))	4. Fire	2. Flame detectors inside TCD system container initiate alarm and shutdown 3. ESD of TCD system 12. Vessel engine is dual fuel 13. Temperature monitoring on motor in TCD container 14. Functional and load monitoring on Molten Salt Recycle Pump 15. Container wall is A-60	Asset	3	C	High	
			7. Unavailability of FGSS and TCD system		Asset	2	C	Moderate	
21.2	Active firefighting (for ferry)	1. Internal fire inside TCD space	1. Fire and explosion	1. CH <sub>4</sub> and H <sub>2</sub> gas detectors inside TCD space initiate alarm and shutdown 2. Flame detectors inside TCD space initiate alarm and shutdown 3. ESD of TCD system 4. Valves designed to be in fail safe mode (i.e., fails open or fails closed valves) 5. Active firefighting system includes CO <sub>2</sub> system to cool down TCD system space	Asset	3	C	High	70. Consider installing equipment inside a separate room with proper relief hatch venting to the upper deck of the ferry. If there is more than two TCD systems, install them in the same space. <b>Status:</b> In Progress

No.: 21		Vessel - Safety Systems (F&G Detection, Active & Passive Firefighting, etc.)							
Item	Deviation	Causes	Consequences	Safeguards	Matrix	S	L	R	Action Items
				6. Ventilation system inside TCD system space (30 air changes/hr) 7. Space is classified as Zone 1 hazardous area classification 8. Vessel fire & gas detection system in the fuel storage space of the ferry (independent from TCD fire & gas detection system) 9. Vessel engine is dual fuel 12. TCD space walls are A-60 fire rated					71. Conduct fire & explosion and gas dispersion studies for TCD space and fuel space to ensure that damage is limited inside the TCD space and/or room and overpressure is properly relieved. <b>Status:</b> In Progress 135. Firefighting for fuel room in ferry are to be considered per IGF code and SOLAS requirements. <b>Status:</b> In Progress 136. Consider providing ventilation rates such that, with the limited inventory in the TCD system, it will never achieve the explosive limit. <b>Status:</b> In Progress
			2. Due to higher explosion pressure, potential impact on fuel space and LNG of FGSS equipment		Asset	4	B	High	
		2. Electrical fire inside TCD space	1. Fire and explosion	2. Flame detectors inside TCD space initiate alarm and shutdown 3. ESD of TCD system 9. Vessel engine is dual fuel 10. Temperature monitoring on motor in TCD container 11. Functional and load monitoring on Molten Salt Recycle Pump 12. TCD space walls are A-60 fire rated	Asset	3	C	High	135. Firefighting for fuel room in ferry are to be considered per IGF code and SOLAS requirements. <b>Status:</b> In Progress
			2. Due to higher explosion pressure, potential impact on fuel space and LNG of FGSS equipment		Asset	4	B	High	

No.: 21		Vessel - Safety Systems (F&G Detection, Active & Passive Firefighting, etc.)							
Item	Deviation	Causes	Consequences	Safeguards	Matrix	S	L	R	Action Items
			5. Unavailability of FGSS and TCD system		Asset	2	C	Moderate	
		3. External fire in ferry fuel storage space	1. Fire and explosion	3. ESD of TCD system 12. TCD space walls are A-60 fire rated	Asset	3	C	High	71. Conduct fire & explosion and gas dispersion studies for TCD space and fuel space to ensure that damage is limited inside the TCD space and/or room and overpressure is properly relieved. <b>Status:</b> In Progress 135. Firefighting for fuel room in ferry are to be considered per IGF code and SOLAS requirements. <b>Status:</b> In Progress 136. Consider providing ventilation rates such that, with the limited inventory in the TCD system, it will never achieve the explosive limit. <b>Status:</b> In Progress
			3. High heat radiation on TCD space walls, leading to temperature increase in TCD system		Asset	2	B	Low	
			5. Unavailability of FGSS and TCD system		Asset	2	C	Moderate	
21.3	Passive firefighting - No significant issues identified. A-60 fire rating of TCD system container is sufficient.	1.							

No.: 22		Vessel - Ship Operation/Simultaneous operation							
Item	Deviation	Causes	Consequences	Safeguards	Matrix	S	L	R	Action Items
22.1	Predetermined shutdown of FGSS or engine	1. Predetermined shutdown of FGSS or engine	1. Blockage of inventory inside TCD system	1. TCD System is designed for safe shutdown and to hold inventory	Asset	2	C	Moderate	6. Interface and communication protocol between FGSS and Rotoboost system is to be established in detailed engineering phase for proper monitoring and shutdown. <b>Status:</b> In Progress 137. Investigate the need for backup fuel for TCD system for long-term or short-term supply shutdown. <b>Status:</b> In Progress
			2. High temperature due to burner operations in Reactor		Asset	2	C	Moderate	
22.2	Emergency or upset shutdown of FGSS or engine	1. Emergency or upset shutdown of FGSS or engine	1. High temperature due to burner operations in Reactor	1. TCD System is designed for safe shutdown and to hold inventory	Asset	2	C	Moderate	6. Interface and communication protocol between FGSS and Rotoboost system is to be established in detailed engineering phase for proper monitoring and shutdown. <b>Status:</b> In Progress 138. Proper study to be conducted on how to vent off produced hydrogen, and if the burner in Reactor needs to be in operation, consider appropriate measures to keep Reactor hot or in operating conditions. <b>Status:</b> In Progress 139. Thermal analysis are to be done considering the number of start/stop cycles of TCD system. <b>Status:</b> In Progress
			2. Blockage of inventory inside TCD system		Asset	2	C	Moderate	

No.: 22		Vessel - Ship Operation/Simultaneous operation							
Item	Deviation	Causes	Consequences	Safeguards	Matrix	S	L	R	Action Items
			3. Solidification - TCD System - Feed Gas Decomposition Reactor (see 2.10)						
22.3	TCD system running while vessel is in port	1. TCD system running while vessel is in port							137. Investigate the need for backup fuel for TCD system for long-term or short-term supply shutdown. <b>Status:</b> In Progress  140. Investigate if TCD system has to be operational while vessel is in port, consider any impact due to local regulations, administrations, or class society rules. Investigate the need for liquid backup fuel for TCD system in case system has to be maintained in hot conditions. <b>Status:</b> In Progress



No.: 23		Vessel - Emergency Escape, Evacuation, and Rescue (EER)							
Item	Deviation	Causes	Consequences	Safeguards	Matrix	S	L	R	Action Items
23.1	Personnel working inside TCD system container (product carrier or VLCC)	1. CH <sub>4</sub> and H <sub>2</sub> leakage while personnel is inside TCD system container	1. Personnel exposure to CH <sub>4</sub> and H <sub>2</sub>	1. Fire and Gas detection 2. PPE 3. Portable gas detectors 4. Visual and audible alarm outside container door 6. TCD container has 2 egress doors 7. Two egress routes from TCD container to vessel lifeboat/mustered area 9. Visual and audible alarms inside TCD container 11. TCD container ventilation system 12. Firefighting systems	Injury	3	C	High	19. From Human Ergonomic and human comfort perspective, provide suitable PPE and develop proper inspection and maintenance procedures to minimise personnel exposure to heat inside container. <b>Status:</b> In Progress  141. Conduct detailed safe working procedures for TCD container or TCD space entrance, when system is running and develop proper training for personnel, including emergency response. <b>Status:</b> In Progress
			2. Fire and explosion		Overall	S3-Moderate	LB-Unlikely	Moderate	
			3. Personnel injury or fatality		Injury	3	B	Moderate	
		2. Personnel working in TCD system container for extended period (intent is to manage container atmosphere is below 45 degC)	5. Personnel discomfort and potential heat exposure due to exothermic process	5. Hot surfaces are protected with insulation 13. Temperature monitoring TE-0002 inside the container will initiate alarm and shutdown (H, HH)	Injury	3	D	High	19. From Human Ergonomic and human comfort perspective, provide suitable PPE and develop proper inspection and maintenance procedures to minimise personnel exposure to heat inside container. <b>Status:</b> In Progress  142. Analyze human comfort levels for personnel working in TCD system container for an extended period of time. Determine appropriate time limit and incorporate into TCD system procedures. <b>Status:</b> In Progress

No.: 23		Vessel - Emergency Escape, Evacuation, and Rescue (EER)							
Item	Deviation	Causes	Consequences	Safeguards	Matrix	S	L	R	Action Items
									143. Temperature management for TCD system container are to be determined. <b>Status:</b> Resolved 144. Operational risk assessments or Job Safety Analysis (JSA) are to be conducted if personnel is expected to work in TCD system container or space for extended period of time. <b>Status:</b> In Progress 145. Weather limitations are to be developed if personnel are expected to work in TCD container. <b>Status:</b> In Progress
		3. Container doors inadvertently open during live equipment maintenance	7. Possibility of gas leak from TCD container to outside of the container	1. Fire and Gas detection 2. PPE 3. Portable gas detectors 4. Visual and audible alarm outside container door	Asset	2	B	Low	146. Consider adding door alarms when the TCD container door is open. <b>Status:</b> In Progress
		4. Container doors inadvertently closed (personnel inside container cannot get out)	6. Personnel exposure to CO <sub>2</sub> in case of CO <sub>2</sub> release due to fire inside container	1. Fire and Gas detection 2. PPE 3. Portable gas detectors 9. Visual and audible alarms inside TCD container 10. PAGA system (communication)	Injury	3	B	Moderate	
		5. Hot surfaces	4. Personnel exposure to hot surfaces	5. Hot surfaces are protected with insulation	Injury	2	B	Low	

No.: 23		Vessel - Emergency Escape, Evacuation, and Rescue (EER)							
Item	Deviation	Causes	Consequences	Safeguards	Matrix	S	L	R	Action Items
23.2	Personnel working inside TCD space inside fuel room (ferry)	1. CH <sub>4</sub> and H <sub>2</sub> leakage while personnel is inside TCD space	1. Personnel exposure to CH <sub>4</sub> and H <sub>2</sub>	1. Fire and Gas detection 2. PPE 3. portable gas detectors 4. Hot surfaces are protected with insulation	Injury	3	C	High	<p>19. From Human Ergonomic and human comfort perspective, provide suitable PPE and develop proper inspection and maintenance procedures to minimise personnel exposure to heat inside container. <b>Status:</b> In Progress</p> <p>104. Provide air locks for entry to TCD space and two means of escape routes or hatches from TCD space inside fuel room of ferry to vessel lifeboat. <b>Status:</b> In Progress</p> <p>144. Operational risk assessments or Job Safety Analysis (JSA) are to be conducted if personnel is expected to work in TCD system container or space for extended period of time. <b>Status:</b> In Progress</p> <p>147. TCD space inside fuel room of ferry to maintain negative pressure compared to surrounding (typically requires exhaust fans) <b>Status:</b> In Progress</p>
			2. Fire and explosion		Overall	S4-Major	LB-Unlikely	High	
			3. Personnel injury or fatality		Injury	3	B	Moderate	

No.: 23		Vessel - Emergency Escape, Evacuation, and Rescue (EER)							
Item	Deviation	Causes	Consequences	Safeguards	Matrix	S	L	R	Action Items
		2. Personnel working in TCD space for extended period of time (intent is to manage container atmosphere is below 45 degC)	5. Personnel discomfort and potential heat exposure		Injury	2	D	High	<p>19. From Human Ergonomic and human comfort perspective, provide suitable PPE and develop proper inspection and maintenance procedures to minimise personnel exposure to heat inside container. <b>Status:</b> In Progress</p> <p>141. Conduct detailed safe working procedures for TCD container or TCD space entrance, when system is running and develop proper training for personnel, including emergency response. <b>Status:</b> In Progress</p> <p>142. Analyze human comfort levels for personnel working in TCD system container for an extended period. Determine appropriate time limit and incorporate into TCD system procedures. <b>Status:</b> In Progress</p> <p>143. Temperature management for TCD system container are to be determined. <b>Status:</b> Resolved</p> <p>144. Operational risk assessments or Job Safety Analysis (JSA) are to be conducted if personnel is expected to work in TCD system container or space for extended period of time. <b>Status:</b> In Progress</p>

No.: 23		Vessel - Emergency Escape, Evacuation, and Rescue (EER)							
Item	Deviation	Causes	Consequences	Safeguards	Matrix	S	L	R	Action Items
									145. Weather limitations are to be developed if personnel is expected to work in TCD container. <b>Status:</b> In Progress
		3. Hot surface	4. Personnel exposure to hot surfaces	4. Hot surfaces are protected with insulation	Injury	2	B	Low	
		4. door inadvertently open or closed (see 23.1)							

No.: 24		Offshore installation							
Item	Deviation	Causes	Consequences	Safeguards	Matrix	S	L	R	Action Items
24.1	TCD system using flare gas or produced gas from FPSO - to use in turbine/engine or export	1. Contaminants inside flare gas	1. Produced carbon with contaminant, disposal issue (not resalable)	1. TCD can be installed to process flare gas to produce H <sub>2</sub> O, H <sub>2</sub> , carbon and/or ammonia, CO or CO <sub>2</sub> , etc.	Overall	S3-Moderate	LC-Possible	High	148. When using flare gas or produced gas from offshore installations to feed TCD system, offshore gas compositions are to be studied and impact on salt or catalysts are to be further investigated. <b>Status:</b> In Progress 149. Carbon produced from offshore produced gas or flare gas is to be studied for any radioactive or contaminants which can hinder transportation and storage. <b>Status:</b> In Progress 150. Produced carbon is to be evaluated for resale value, and if not marketable, then disposals of carbons are to be studied. <b>Status:</b> In Progress
			2. TCD system efficiency is compromised (reduced H <sub>2</sub> production) due to contaminants		Asset	2	C	Moderate	151. Need for pre-treatment of flare gas need to be evaluated for use in TCD system. <b>Status:</b> In Progress
			3. Water in flare gas can degrade catalysts in TCD system		Asset	3	C	High	152. Investigate compressing H <sub>2</sub> in storage tank and exporting <b>Status:</b> In Progress
			4. high H <sub>2</sub> S and CO <sub>2</sub> can impact TCD system		Asset	3	C	High	153. Percentage of H <sub>2</sub> that can be burned in turbine and engine need to be investigated. <b>Status:</b> In Progress 154. Storage of carbon produced, and offloading are to be further investigated <b>Status:</b> In Progress

No.: 24		Offshore installation							
Item	Deviation	Causes	Consequences	Safeguards	Matrix	S	L	R	Action Items
			5. Naturally occurring radioactive elements can occur in produced carbon		Asset	2	B	Low	
		2. Contaminants carryover in fuel gas	6. Engine/turbine performance impacted		Asset	3	C	High	<p>148. When using flare gas or produced gas from offshore installations to feed TCD system, offshore gas compositions are to be studied and impact on salt or catalysts are to be further investigated. <b>Status:</b> In Progress</p> <p>149. Carbon produced from offshore produced gas or flare gas is to be studied for any radioactive or contaminants which can hinder transportation and storage. <b>Status:</b> In Progress</p> <p>150. Produced carbon is to be evaluated for resale value, and if not marketable, then disposals of carbons are to be studied. <b>Status:</b> In Progress</p> <p>151. Need for pre-treatment of flare gas need to be evaluated for use in TCD system. <b>Status:</b> In Progress</p> <p>152. Investigate compressing H<sub>2</sub> in storage tank and exporting <b>Status:</b> In Progress</p> <p>153. Percentage of H<sub>2</sub> that can be burned in turbine and engine need to be investigated. <b>Status:</b> In Progress</p>

No.: 24		Offshore installation							
Item	Deviation	Causes	Consequences	Safeguards	Matrix	S	L	R	Action Items
									154. Storage of carbon produced, and offloading are to be further investigated <b>Status:</b> In Progress



# Appendix XIV – Detailed Regulatory Gap Analysis

No Gap or Changes needed to address hydrogen as marine fuel
Small Gap or Minor Change to address hydrogen as marine fuel
Medium Gap or Some Challenging Change to address hydrogen as marine fuel
Large Gap or Many Challenging Changes to address hydrogen as marine fuel

Subject	Code/Standard Title	Comment on Code/Standard - Benefits	Comment on Code/Standard - Gaps	General Comments	Contribute / Restrain uptake of Hydrogen as Marine Fuel
Sustainability and Emissions Regulations	MARPOL Annex VI Regulation 14 - Sulphur Oxides (SOx) and Particulate Matter	- No SOx emissions are generated from fuel cells or mono-fuel hydrogen combustion engines.	- No significant gaps for supporting the application of hydrogen	International regulators are pivoting to adopt more stringent emissions regulations to reduce the impacts to climate change. Various efforts in the European Union to adopt more renewable energy sources throughout its industrial and transportation markets can include the	<u>Contribute.</u> International policy which drives the adoption of renewable hydrogen in various industry can increase the uptake of the fuel in all industries. The regulations force industries to look to renewable solutions or face consequences by using or continuing to use polluting fuels.
	EU 'Fit-for-55' FuelEU Maritime	- Considers decarbonised hydrogen as renewable and low-carbon fuel (RLF) for international maritime transport - Supports setting clear regulatory environment for hydrogen as marine fuel - Economic incentives for positive change or to adopt hydrogen	- Focus is only on decarbonised (green) hydrogen		

Subject	Code/Standard Title	Comment on Code/Standard - Benefits	Comment on Code/Standard - Gaps	General Comments	Contribute / Restrain uptake of Hydrogen as Marine Fuel
	EU Emissions Trading System (ETS)	<ul style="list-style-type: none"> <li>- Economic incentives for positive change to reduce CO<sub>2</sub> emissions or to adopt hydrogen</li> </ul>	<ul style="list-style-type: none"> <li>- Not directly applicable to shipping industry (until 2023 adoption of the 'Fit-for-55' package)</li> <li>- Only focused on tank-to-wake emissions, does not incorporate emissions from production</li> </ul>	<p>increased use of renewable fuels of non-biological origin (RFNBO). RFNBOs include renewable hydrogen as fuel, and this is being considered as one which can meet the goals for reduced emissions. Local regulators influence required change on a smaller scale but can also allow for more comprehensive solution to adopting hydrogen solutions for decarbonization.</p>	<p>The carbon-free characteristics of hydrogen is a driver for adoption and viability to address national and international decarbonization efforts.</p>
	MARPOL Annex VI Regulation 13 - Nitrogen Oxides, and NOx Technical Code (NTC)	<ul style="list-style-type: none"> <li>- When consumed in fuel cells, no NOx emissions are generated, allowing hydrogen fuel cell applications exempt from NTC requirements in MARPOL Annex VI</li> </ul>	<ul style="list-style-type: none"> <li>- No significant gaps for supporting the application of hydrogen consumption in fuel cells.</li> <li>- Where hydrogen consumed in internal combustion engines, systems are to meet NTC</li> </ul>		
	EU RED III	<ul style="list-style-type: none"> <li>- Considers hydrogen as a marine fuel produced from renewable energy</li> <li>- Supports renewable fuels</li> <li>- Economic incentives for positive change or to adopt hydrogen</li> </ul>	<ul style="list-style-type: none"> <li>- Divided incentives for shipowners and operators do not stimulate the deployment of renewable fuels</li> <li>- Focus is only on decarbonised (green) hydrogen</li> <li>- Member states independently implement national policy</li> </ul>		
	EU Energy Taxation Directive (ETD)	<ul style="list-style-type: none"> <li>- Structural rules and minimum rates for excise duties to tax energy products used as motor and heating fuels and for electricity.</li> </ul>	<ul style="list-style-type: none"> <li>- Maritime sector fully exempt from directive</li> <li>- Member states independently implement national policy</li> </ul>		
	MARPOL Annex VI EEDI, EEXI, CII & DCS	<ul style="list-style-type: none"> <li>- Carbon Indexing and limits for ships is met by using hydrogen as fuel, even though hydrogen fuel does</li> </ul>	<ul style="list-style-type: none"> <li>- No explicit provision in IMO regulations and guidelines for the direct use of a hydrogen carbon factor in EEDI, EEXI, CII and DCS</li> <li>- Provision for well-to-wake emissions should be considered in these instruments</li> </ul>		

Subject	Code/Standard Title	Comment on Code/Standard - Benefits	Comment on Code/Standard - Gaps	General Comments	Contribute / Restrain uptake of Hydrogen as Marine Fuel
		not have a Carbon Factor			
	Japan Regulation for Enforcement of the Air Pollution Control Act	- Information about required reporting scheme for emissions from gas generators, including reformers for hydrogen production and fuel cells.	- Not specific to marine hydrogen applications, but could be interpreted as also applying to marine emissions in Japan		
	MARPOL Annex VI Regulation 18 - Fuel Oil Availability and Quality	- When consumed in fuel cells, no NOx emissions are generated, allowing hydrogen fuel cell applications exempt from NTC requirements in MARPOL Annex VI	- Regulation 18 of Annex VI would benefit from clarification on BDN and fuel sampling obligations for hydrogen as fuel - Application of hydrogen as fuel (particularly for retrofits) would benefit from clarification on application of regulation 18.3.2.2 for NOx implications where hydrogen is derived from methods other than petroleum refining		
Storage	ASME BPVC Section VIII Rules for Construction of Pressure Vessels, Division 1, Division 2-Alternative Rules & Division 3- Alternative Rules for Construction of High-Pressure Vessels	- Considers general and specific provisions for hydrogen containment vessels in gaseous service	- Not specific to marine, may be referenced in marine standards	Where hydrogen has been used in industry in the past, land-based storage of the chemical for industrial purposes or land-based fuel has been done	<u>Contribute.</u> Previous land-based experience and existing standards for storing hydrogen can promote the uptake of the chemical as a marine fuel, not only to improve

Subject	Code/Standard Title	Comment on Code/Standard - Benefits	Comment on Code/Standard - Gaps	General Comments	Contribute / Restrain uptake of Hydrogen as Marine Fuel
	CGA H-3 Standard for Cryogenic Hydrogen Storage	- Applies to tanks for liquid hydrogen storage at cryogenic temperatures	- Not specific to marine, may be referenced in marine standards	for many years. The transition and possible modification of this technology and general practice is not expected to be difficult for marine applications.  There may be challenges related to unifying requirements for marine hydrogen fuel storage. Where a number of standards exist, detailed gap analyses may be required to compare the scope and specific provisions for gaseous and liquefied hydrogen containment.	probabilities of availability, but also to share lessons learned and form the basis of understanding for storing and handling the chemical with the marine regulatory community.
CGA S-1 Pressure Relief Device Standards Part 1 & 2	- Applicable to cylinders for stationary and portable storage of compressed gases, including hydrogen	- Not specific to marine, may be referenced in marine standards			
U.S. 40 CFR Ch. I Subchapter J Part 370 Hazardous Chemical Release Reporting: Community right-to-know	- Lists the release of hazardous chemicals that require MSDS or SDS as reportable to the general public	- No significant gaps for supporting the application of hydrogen			
UK BSI Pressure Equipment Regulations (PER) 1999	- Includes requirements for handling gases, including hydrogen	- Not specific to marine, may be referenced in marine standards or updated to include marine standards for pressure equipment in hydrogen use			
MSC.420(97)	- Specific to ships carrying liquefied hydrogen in bulk - Can support availability or familiarity of marine hydrogen applications	- No significant gaps for supporting the application of hydrogen fuel			
ISO 13985:2006 Liquid Hydrogen - Land vehicle fuel tanks	- Specifications for liquid hydrogen fuel tanks intended to be permanently attached to a land vehicle.	- Not specific to marine fuel tanks, but may be referenced in marine standards or updated to include specifications for maritime use			

Subject	Code/Standard Title	Comment on Code/Standard - Benefits	Comment on Code/Standard - Gaps	General Comments	Contribute / Restrain uptake of Hydrogen as Marine Fuel
	ISO 19881:2018 Gaseous Hydrogen - Land vehicle fuel containers	- Specifications for gaseous hydrogen refillable fuel tanks for storage or for use on light-duty vehicles, heavy-duty vehicles, and industrial powered trucks such as forklifts.	- Not specific to marine fuel tanks, but may be referenced in marine standards or updated to include specifications for maritime use		
	ISO 19882:2018 Gaseous Hydrogen - Thermally activated pressure relief devices for compressed hydrogen vehicle fuel containers	- In relation to ISO 19881 tanks, specification for pressure relief systems on fuel containers for hydrogen-powered vehicles.	- Not specific to marine fuel tanks, but may be referenced in marine standards or updated to include specifications for maritime use		
	ISO 16111 Transportable gas storage devices - Hydrogen absorbed in reversible metal hydride	- Specifications for metal hydride assemblies to transmit hydrogen - Not covering fixed fuel-storage onboard hydrogen-fuelled vehicles	- Does not discuss system used for hydrogen fuel -May be referenced in fuel standards or updated to include provisions for use as fuel storage and containment		
	IMO IGF Code	- Hydrogen considered as marine fuel under alternative approval scheme	- IGF Code Part A-1 and IGC Code prescriptive provisions are specifically for natural gas (methane). Alternative Design process enables approval of other gases and low flashpoint fuels or cargoes but could be revised to include specific provisions for hydrogen in the longer term.	As discussed in Section 3.2.2, the inclusion of hydrogen in the IMO's low-flashpoint fuels codes (IGF/IGC) has highlighted the practice and understanding of using the	<u>Contribute.</u> Onboard storage rules and regulations from Marine Regulatory Bodies (international, national, and regional) support the uptake of
	IMO IGC Code	- Hydrogen considered as cargo under alternative approval scheme			

Subject	Code/Standard Title	Comment on Code/Standard - Benefits	Comment on Code/Standard - Gaps	General Comments	Contribute / Restrain uptake of Hydrogen as Marine Fuel
				chemical as a marine fuel and cargo to decarbonise or reduce end-use emissions according to the IMO and other decarbonization goals and initiatives.	hydrogen as marine fuel. Whether for specific applications or general directives, available codes of practice for safely storing hydrogen on board ships (for cargo or as fuel) can help designers, users, and owners understand the realistic considerations of adopting hydrogen as marine fuel on marine assets.
Quality	ISO 14687:2019 Hydrogen Fuel Quality - Product Specification	- Defines quality of hydrogen fuel for stationary uses and for vehicles.	- Not specific to marine service, but may be referenced in marine standards or updated to include specific requirements for marine service	As a carbon-free fuel and based on historical precedence of use in petroleum refining and other industries, hydrogen quality standards are well understood	<u>Contribute</u> . It is beneficial that hydrogen, as a pure chemical fuel, has existing quality standards for industry and use as fuel in fuel cells.
	SAE J2719 Hydrogen Fuel Quality for Fuel Cell Vehicles	- Specifies hydrogen quality standard for proton exchange membrane fuel cell powered vehicles	- Not specific to marine systems but may be referenced in marine standards - This and other Standards from the SAE Fuel Cell Standards Committee are applicable to road vehicles, but may provide best practices and guidance to marine systems		
	SAE J3219_202206 Hydrogen Fuel Quality Screening	- Specifies hydrogen quality test standard			

Subject	Code/Standard Title	Comment on Code/Standard - Benefits	Comment on Code/Standard - Gaps	General Comments	Contribute / Restrain uptake of Hydrogen as Marine Fuel
	Test of Chemicals for Fuel Cell Vehicles	for use in fuel cells on vehicles		and are not expected to be a difficult challenge to adopt for marine fuel use.	
	CIMAC WG17 Guideline on Hydrogen in Stationary 4-Stroke Gas Engines for Power Generation	- Addresses the application of hydrogen in combustion engines as pure fuel or blended with LNG	- Not specific to marine fuels or engines in marine service, but may be referenced in marine standards or updated to include other types of engines or power generation service		
	International Bunker Industry Association	- Future Fuels Working group assesses hydrogen as alternative marine bunker fuel, preparing to develop position papers and consultancy for the IMO	- No specific guidance for hydrogen		
	ISO 8217:2017 Petroleum Products - Fuels (class F) - Specifications of Marine Fuels		- Not applicable to and does not discuss hydrogen as marine fuel - Additional provisions for hydrogen specification (including hydrogen blends) for marine fuel may be developed as a new standard		
	MARPOL Annex VI Regulation 18 - Fuel Oil Availability and Quality	- When consumed in fuel cells, no NOx emissions are generated, allowing hydrogen fuel cell applications exempt from NTC requirements in MARPOL Annex VI	- Regulation 18 for fuel oil availability and quality requires onboard fuel to be tested for sulphur content and seal fuel samples for the record. While regulation 18.4 exempts gas fuels from BDN and fuel sample requirements, regulation 18 would benefit from explicit clarification on BDN and fuel sampling obligations for hydrogen or hydrogen blends with LNG as fuel		

Subject	Code/Standard Title	Comment on Code/Standard - Benefits	Comment on Code/Standard - Gaps	General Comments	Contribute / Restrain uptake of Hydrogen as Marine Fuel
Transportation & Handling	MSC.1/Circ 1599, 2019 Interim Guidelines on the Application of High Manganese Austenitic Steel for Cryogenic Services	- Guideline for using advanced material for cryogenic services, including those at temperatures for liquefied hydrogen service	- No significant gaps for supporting the application of liquefied (cryogenic) hydrogen	Considering the historical experience from industry of best practices to transport and handle hydrogen safely, from the design of pipelines to testing setups, the marine industry can benefit from existing experience standardised codes and practices for transporting and handling of hydrogen.	<u>Contribute.</u> Industrial practices for handling and transporting hydrogen can translate into and contribute to marine rules and regulations covering the safe handling of the chemical on board vessels and streamline the process of adopting hydrogen as marine fuel.
	MSC.1/Circ. 1622, 2020 Guidelines for the Acceptance of Alternative Metallic Materials for Cryogenic Service in Ships Carrying Liquefied Gasses in Bulk and Ships Using Gases or Other Low-Flashpoint Fuels	- Guideline for using advanced material for cryogenic services, including those at temperatures for liquefied hydrogen service			
	CGA 5.4 Standard for Hydrogen Piping Systems at User Locations	- Applicable to gaseous and liquified hydrogen piping systems regarding design, fabrication, installation, use, and maintenance.	- Not specific to marine, may be referenced in marine standards	There may be challenges related to unifying requirements for marine hydrogen fuel storage, transportation, and handling. Where a number of standards exist,	
	CGA G-5.5 Hydrogen Vent Systems	- Standard for ventilation systems can be applicable to marine applications			
	UK BPI EPS Regulations 1996	- Includes equipment and safety systems to be used in potentially explosive atmospheres, including those	- Not specific to marine, may be referenced in marine standards or updated to include specific considerations for marine hydrogen systems		



Subject	Code/Standard Title	Comment on Code/Standard - Benefits	Comment on Code/Standard - Gaps	General Comments	Contribute / Restrain uptake of Hydrogen as Marine Fuel
		related to hydrogen service		detailed gap analyses may be required to compare the scope and specific provisions for gaseous and liquefied hydrogen transportation and handling for marine use cases.	
	UK BPI DSEAR 2002	- Includes equipment and safety systems to be used in potentially explosive atmospheres, including those related to hydrogen service			
	GB/T 40060-2021 Technical requirements for storage and transportation of liquid hydrogen	- Chinese standard specifications for liquid hydrogen storage systems and transportation, including storage vessel, transport vehicle, and tank containers.	- Not specific to marine systems but may be referenced in marine standards		
	U.S. 29 CFR Ch. XVII Part 1910 Subpart H: Occupational Safety and Health Standards: 103 Hydrogen	- OSHA standards for hydrogen system design, construction, location, installation and operation of gaseous and liquefied systems	- No significant gaps for supporting the application of hydrogen		
	ASME B31.12-2019 Hydrogen Piping and Pipelines	- Includes specific provisions for hydrogen pipes in gaseous or liquid service, including materials, welding, testing, inspection,	- Not specific to marine, may be referenced in marine standards		

Subject	Code/Standard Title	Comment on Code/Standard - Benefits	Comment on Code/Standard - Gaps	General Comments	Contribute / Restrain uptake of Hydrogen as Marine Fuel
		operations and maintenance.			
	ISO/TR 15916:2015 - Basic considerations for the safety of hydrogen systems	- Applicable to gaseous and liquified hydrogen systems for storage and utilization of hydrogen fuel. - Not limited to specific applications	- Safety requirements for hydrogen handling operations not covered - May be referenced in marine standards or updated to include specific considerations for marine hydrogen systems		
	AS ISO 15916:2021 Basic considerations for the Safety of Hydrogen Systems	Australian adoption of ISO standard with additional Appendix for use of the standard in Australia			
	NFPA 2 Hydrogen Technologies Code, Edition 2	- Establishes fundamental safety measures for production, installation, storage, piping, use and handling of hydrogen in compressed gas or cryogenic liquid form	- May be applicable to marine systems or referenced within marine standards. - May be updated to include provisions for hydrogen systems for marine use.		
	NFPA 55 Standards for Storage, Use and Handling of Compressed Gases and Cryogenic Fluids in Portable and Stationary Containers, Cylinders and Tanks				

Subject	Code/Standard Title	Comment on Code/Standard - Benefits	Comment on Code/Standard - Gaps	General Comments	Contribute / Restrain uptake of Hydrogen as Marine Fuel
	SIGTTO Liquefied Petroleum Gas Sampling Procedures	- Evidence of previous technology adoption and standards/procedures for handling similar novel technologies	- Not applicable to hydrogen. SIGTTO could produce similar recommendations for hydrogen gas cargo or fuel		
	Japan Association of Hydrogen Supply and Utilization Technology (HySUT) Guidelines	- Include Guidelines for hydrogen utilization that focus on road-based technologies	- Not specific to or considers marine applications		
	Japan High Pressure Gas Safety Act	- Specifies regulations for lifecycle of high-pressure gas, including hydrogen	- Not specific to marine		
Bunkering	ISO 20159:2021 - Ships and Marine Technology - Specification for bunkering of liquefied natural gas fuelled vessels	- Standard related to liquefied natural gas bunkering	- Not applicable to hydrogen or gaseous systems. Could be modified or used to develop liquefied hydrogen bunkering guidelines	Various global uses and phases of hydrogen for industry or other use may lead to the use of non-standard or incompatible bunkering and transfer mechanisms. This issue was observed during the adoption of LNG as marine fuel, where industrial quality standards, handling,	<u>Restrain</u> . Non-uniform international standards or codes for chemical transfer technology and compatible bunkering infrastructure can make it difficult to adopt hydrogen as a fuel. Similar to standard requirements for fuel oil manifolds or shore
	ISO/TS 18683:2021 - Guidelines for safety and risk assessment of LNG fuel bunkering operations	- Standard related to liquefied natural gas bunkering			
	ISO 21593:2019 - Ships and Marine Technology - Technical requirements for dry-	- Standard related to liquefied natural gas bunkering			

Subject	Code/Standard Title	Comment on Code/Standard - Benefits	Comment on Code/Standard - Gaps	General Comments	Contribute / Restrain uptake of Hydrogen as Marine Fuel
	disconnect/connect couplings for bunkering liquefied natural gas			storage, and consumption codes or practices exist, but a disconnect in transfer practices was a major challenge to achieve the widespread adoption and use of it as marine fuel.	connection boxes, the development of specific designs for transferring and bunkering hydrogen may be essential to adopt the chemical as marine fuel.
ISO 13984:1999 Liquid Hydrogen - Land vehicle fuelling system interface	- Standard related to land vehicle fuelling of liquid hydrogen	- Not specific to marine bunkering systems, but may be referenced in marine standards or updated to include marine bunkering of liquid hydrogen			
ISO 17268:2020 Gaseous hydrogen land vehicle refuelling connection devices	- Specifications for hydrogen refuelling connectors for gaseous land vehicles	- Not applicable to liquid hydrogen - Not specific to marine bunkering systems, but may be referenced in marine standards or updated to include marine bunkering of gaseous hydrogen			
ISO 19880 Gaseous Hydrogen - Fuelling Stations	- Specification series to gaseous hydrogen fuelling facilities for light-duty automobiles.				
SAE J2601/2_201409 Fueling Protocol for Gaseous Hydrogen Powered Heavy Duty Vehicles	- Specification of protocol for gaseous hydrogen fuelling of heavy-duty automobiles.	- Not applicable to liquefied hydrogen - Not specific to marine bunkering systems, but may be referenced in marine standards			
IACS Recommendation No. 142 LNG Bunkering Guidelines	- Covers general guidelines to LNG bunkering	- Could be updated to cover bunkering guidelines for all liquefied gases or new publication could be developed			
SIGTTO Ship/Shore Interface for LPG/Chemical Gas Carriers and Terminals	- Related to IGC code for LPG and chemical gas carriers	- SIGTTO publications address liquefied gases including hydrogen, but could provide specific guidance for hydrogen gas cargo or fuel			

Subject	Code/Standard Title	Comment on Code/Standard - Benefits	Comment on Code/Standard - Gaps	General Comments	Contribute / Restrain uptake of Hydrogen as Marine Fuel
	SIGTTO Recommendations for Liquefied Gas Carrier Manifolds	- Related to LPG and LNG carrier manifolds and safe cargo transfer equipment			
	SIGTTO Liquefied Gas Handling Principles on Ships and Terminals (LGHP4)	- Related to LNG, LPG and chemical gasses on ships and at the shore interface			
	SIGTTO, CDI, ICS, OCIMF: Ship to Ship Transfer Guide for Petroleum, Chemicals and Liquefied Gases	- Related to all ships involved in transfer activities of all types of bulk liquid cargoes	- Could be modified or used to develop recommendations for hydrogen bunkering		
	SGMF Bunkering Area Safety information LNG (BASiL)	- Related to bunkering interface, port permitting and establishing safety and security zones of ISO standards	- Not applicable to hydrogen. SGMF could expand these tools and guidelines, or develop new, to cover hydrogen as fuel		
	SGMF FP02-01 Ver1.0 Gas as a marine fuel: Recommendation of Controlled Zones during LNG bunkering; May 2018	- Related to safe bunkering of LNG as marine fuel			
	SGMF FP07-01 Ver3.0 LNG as a marine fuel: Safety and Operational Guidelines - Bunkering; December 2021	- Related to safe bunkering of LNG as marine fuel			

Subject	Code/Standard Title	Comment on Code/Standard - Benefits	Comment on Code/Standard - Gaps	General Comments	Contribute / Restrain uptake of Hydrogen as Marine Fuel
	SGMF FP-08-01 Ver1.0 Gas as a marine fuel: Simultaneous Operations (SIMOPs) during LNG bunkering; May 2018	- Related to safe bunkering of LNG as marine fuel			
	SGMF FP05-01 Ver1.0 Gas as a marine fuel: Contractual guidelines; September 2015	- Related to safe bunkering of LNG as marine fuel			
	SGMF TGN06-04 Ver1.0 Gas as a marine fuel: manifold arrangements for gas-fuelled vessels; May 2019	- Related to manifold arrangement of gas-fuelled vessels			
	SGMF TGN06-06 Ver1.0 Gas as a marine fuel: LNG bunkering with hose bunker systems: considerations and recommendations; February 2020	- Related to safe bunkering of LNG as marine fuel			
	SGMF TGN06-07 Ver1.0 Gas as a marine fuel: Bunker station location: Considerations and	- Related to safe bunkering of LNG as marine fuel			

Subject	Code/Standard Title	Comment on Code/Standard - Benefits	Comment on Code/Standard - Gaps	General Comments	Contribute / Restrain uptake of Hydrogen as Marine Fuel
	Recommendations: January 2021				
	EMSA <i>Guidance on LNG Bunkering to Port Authorities and Administrations</i> ; January 2018	- Related to safe bunkering of LNG as marine fuel	- Not applicable to hydrogen. EMSA could expand or use this tool to develop hydrogen guidance		
Generation, Use & Consumption	MSC.1/Circ. 1647 <i>Interim guidelines for the safety of ships using fuel cell power installations</i>	- Supports the adoption and use of hydrogen as fuel in fuel cells	- No significant gaps for supporting the application of hydrogen	Historical and continuous experience, research, published studies and codes of practice for consuming hydrogen for power generation, either by the use of internal combustion engines or with a fuel cell, can contribute to global knowledge databases on the chemical as a fuel.  However,	<u>Contribute.</u> Codes, standards and regulations covering the subject of fuel supply to consumers, and details about optimization of the chemical in the combustion cycle or within fuel cells all contribute to global knowledge and understanding of hydrogen as marine fuel.  Ongoing studies and research to support the implementation of hydrogen in
	GB/T 40045-2021 Fuel Specifications for hydrogen powered vehicles - Liquid Hydrogen (LH <sub>2</sub> )	- Chinese standard for liquid hydrogen powered proton exchange membrane fuel cell vehicles, including test procedures and standards for fuel specification	- Not specific to marine systems but may be referenced in marine standards		
	GB/T 40061-2021 Technical specification for liquid hydrogen production system	- Chinese standard for liquid hydrogen production systems, including liquefaction, storage, and other safety systems			
	ISO 16110 Hydrogen generators using fuel processing technologies	- Standard for hydrogen production systems that transform fuel input to hydrogen, e.g., fuel	No significant gaps for supporting the application of marine fuel cells, however, may not be applicable for hydrogen fuel systems that do not need reforming for use in fuel cells.		

Subject	Code/Standard Title	Comment on Code/Standard - Benefits	Comment on Code/Standard - Gaps	General Comments	Contribute / Restrain uptake of Hydrogen as Marine Fuel
		reformer intended for fuel cells		experience with the design and use of internal combustion engines running on hydrogen is small but growing, as engine manufacturers begin to examine what technical specifications are required for engines to run on pure or dual fuel with hydrogen.  There may be challenges related to unifying requirements for marine combustion systems. Where a number of standards exist, detailed gap analyses may be required to compare the	large engines and fuel cells onboard vessels will continue to grow the industry's collective experience for further adoption and widespread use of hydrogen as marine fuel.  <u>Restrain.</u> Where standards exist for marine emissions, the adoption of hydrogen as fuel may be restricted. Limited experience using hydrogen as fuel (especially for internal combustion) may lead to unknown or unexpected emissions, including nitrogen oxides (NO <sub>x</sub> ), N <sub>2</sub> O (nitrous oxide, a chemical with the
	IMO draft <i>Interim Guidelines for the Safety of Ships using Fuel Cell Power Installations</i>	- Applicable to hydrogen systems being used in fuel cells for power generation on ships	No significant gaps for supporting the application of marine fuel cells, however these guidelines do not cover fuel storage and distribution and therefore application is limited by lack of those IMO requirements		
	IMO IGF Code	- Hydrogen considered as marine fuel under alternative approval scheme	- IGF Code Part A-1 prescriptive provisions are specifically for natural gas (methane). Alternative Design process enables approval of other gases and low flashpoint fuels, but could be revised to include specific provisions for hydrogen in the longer term.		
	SAE 2579_201906 Standard for Fuel Systems in Fuel Cell and Other Hydrogen Vehicles	- Specifies fuel systems for fuel cell power use on vehicles	- Not specific to marine systems but may be referenced in marine standards - This and other Standards from the SAE Fuel Cell Standards Committee are applicable to road vehicles, but may provide best practices and guidance to marine systems		
	ISO 22734:2019 Hydrogen generators using water electrolysis - Industrial, commercial, and residential applications	- Specifies design, performance and safety requirements for electrolyzers - Specific to electrolyzers used for indoor and outdoor residential, industrial and commercial uses	- Not specific to marine, may be referenced in marine standards or updated to include specific considerations for marine hydrogen systems		
	ISO 19882:2018 Gaseous Hydrogen - Thermally activated pressure relief devices for compressed hydrogen vehicle fuel containers	- In relation to ISO 19881 tanks, specification for pressure relief systems on fuel containers for hydrogen-powered vehicles.	- Not specific to marine fuel tanks, but may be referenced in marine standards or updated to include specifications for maritime use		



Subject	Code/Standard Title	Comment on Code/Standard - Benefits	Comment on Code/Standard - Gaps	General Comments	Contribute / Restrain uptake of Hydrogen as Marine Fuel
	ISO 19883:2017 Safety of pressure swing adsorption systems for hydrogen separation and purification	- Specification for pressure swing adsorption systems for hydrogen separation and purification, including both stationary and skid-mounted systems, including safety precautions and related design elements	- Not specific to non-stationary applications, may be referenced in marine standards or updated to include specifications for maritime use	scope and specific provisions for gaseous and liquefied hydrogen power generation systems for maritime use.	GHG potential to be almost 300 times more potent than CO <sub>2</sub> ). Where these emissions are regulated, specifically from international marine codes, and the emissions are found to be difficult to limit or manage, the adoption of hydrogen as marine fuel may experience resistance.
	ISO 26142:2010 Hydrogen detection apparatus - Stationary applications	- Specifications for hydrogen detectors in stationary applications, including performance criteria for selectivity, toxicity, measurement range, stability, reaction time, and precision.	- Not specific to non-stationary applications, may be referenced in marine standards or updated to include specifications for maritime use	When considering emissions from hydrogen engines or fuel cells, there may develop resistance if emissions from nitrogen in combustion (resulting in NO <sub>x</sub> or N <sub>2</sub> O) cannot be contained or controlled. Care must be taken that in the attempt to reduce carbon emissions, other – potentially more dangerous emissions – are not allowed to be released. Some emissions	
	AS 26142:2020 Hydrogen Detection Apparatus - Stationary Applications	Australian adoption of ISO standard with additional Appendix for use of the standard in Australia			
	SIGTTO ESD Systems - Recommendations for Emergency Shutdown and Related Safety Systems		- SIGTTO publications cover gas carriers and carriage of hydrogen but could benefit from specific consideration for hydrogen gas cargo or fuel		

Subject	Code/Standard Title	Comment on Code/Standard - Benefits	Comment on Code/Standard - Gaps	General Comments	Contribute / Restrain uptake of Hydrogen as Marine Fuel
	SIGTTO Recommendations for Relief Valves on Gas Carriers			regarding hydrogen consumption can be addressed using selective catalytic reduction (SCR) technology post-combustion, but these may be prohibitively expensive to allow for economic feasibility using hydrogen as fuel.	
	SIGTTO Guidelines for the Alleviation of Excessive Surge Pressures on ESD for Liquefied Gas Transfer Systems				
	IACS Recommendation Nos.26, 27 and 30; recommended spare parts for internal combustion engine (main and auxiliary) and essential auxiliary machinery		- Could be updated to cover spare parts for DF hydrogen engines and fuel supply systems		
	IACS Recommendation No.138 Recommendation for the FMEA process for diesel engine control systems				
	IACS <i>Ammonia bunkering guidelines</i>	- Covers general guidelines to ammonia bunkering	- Could be updated to cover bunkering guidelines for all liquefied gases or new publication could be developed		
	IACS Classification Societies Rules		Harmonization of Class Society rules or guidelines, through the development of Unified Requirements, would facilitate harmonised application of hydrogen as fuel		

Subject	Code/Standard Title	Comment on Code/Standard - Benefits	Comment on Code/Standard - Gaps	General Comments	Contribute / Restrain uptake of Hydrogen as Marine Fuel
	American Bureau of Shipping <i>Requirements for Hydrogen Fueled Vessels</i>	- Supports liquid and gaseous hydrogen fuel applications in fuel cells and combustion engines, focused on risk assessment and gas dispersion analysis	No gaps for supporting the application of marine hydrogen fuel. Includes fuel storage, bunkering, and fuel supply system.		
	SGMF FP00-01-06 Ver4.0 LNG as a marine fuel: An Introductory Guide; June 2021	- Related to LNG only, providing general recommendations on the use of LNG as marine fuel and safety and environmental considerations of its use	- Not applicable to hydrogen (focus is on LNG). SGMF could expand or develop new publications for hydrogen as fuel		
	SGMF FP10-01 Ver1.0 Gas as a marine fuel: Work practices for maintenance, repair and dry-dock operations; May 2020	- Related to operations of LNG fuelled vessel			
	SGMF FP14-01 Ver1.0 Gas as a marine fuel: Operations of ships with Liquefied Natural Gas (LNG) competency and assessment guidelines; May 2021	- Related to operations of LNG fuelled vessel			

Subject	Code/Standard Title	Comment on Code/Standard - Benefits	Comment on Code/Standard - Gaps	General Comments	Contribute / Restrain uptake of Hydrogen as Marine Fuel
	SGMF TGN06-05 Ver1.0 Gas as a marine fuel: recommendations for linked emergency shutdown (ESD) arrangements for LNG bunkering; May 2019	- Related to LNG ESD Procedures			
	IMO STCW Convention		- Regulation for training of crew for IGF Code ships exists under STCW Convention. Question remains on the application of hydrogen under IGF Code, but development of training courses and certification by flag Administrations is still required to enable crew certification for hydrogen as fuel under STCW.		
	IACS UR M78 <i>Safety of Internal Combustion Engines Supplied with Low Pressure Gas</i>	- Related to low pressure trunk piston engines using gas (methane) as fuel.	- Does not cover high pressure and cross-head (2-stroke slow speed) engines burning gas. - Does not cover other low flashpoint fuels. - Could be updated to include all engine types and fuels in more general way		
	IACS Recommendation No.146 <i>Risk assessment as required by the IGF Code.</i>	- Specific to fuels covered by IGF Code.	- Could be updated to include specific requirements for hydrogen		
	ISM Code	- Standard for ship management and operation includes provisions to protect against pollution	Development of operational requirements under IGF Code, or Interim Guidelines, would facilitate operators undertaking obligations under ISM Code		