



May 14, 2024

Marine Investigation Preliminary Report

Contact of Containership *Dali* with the Francis Scott Key Bridge and Subsequent Bridge Collapse

Location:	Baltimore, Maryland	Accident Number:	DCA24MM031
Date and Time:	March 26, 2024 0129 local time (eastern daylight time)	IMO Number:	9697428
Ship:	<i>Dali</i> (Neo-Panamax containership)	Injuries:	8 (6 fatal)

On March 26, 2024, about 0129 eastern daylight time, the 947-foot-long Singapore-flagged cargo vessel (containership) *Dali* was transiting out of Baltimore Harbor in Baltimore, Maryland, when it experienced a loss of electrical power and propulsion and struck the southern pier supporting the central truss spans of the Francis Scott Key Bridge (Key Bridge). A portion of the bridge subsequently collapsed into the river, and portions of the deck and the truss spans collapsed onto the vessel’s forward deck (see figure 1). A seven-person road maintenance crew employed by Brawner Builders—which was contracted by the Maryland Transportation Authority (MDTA)—and one inspector employed by Eborn Enterprises, Inc., a subconsultant to the MDTA, were on the bridge when the vessel struck it. The inspector escaped unharmed, and one of the construction crewmembers survived with serious injuries. The bodies of the six fatally injured construction crewmembers have been recovered. One of the 23 persons aboard the *Dali* was injured.

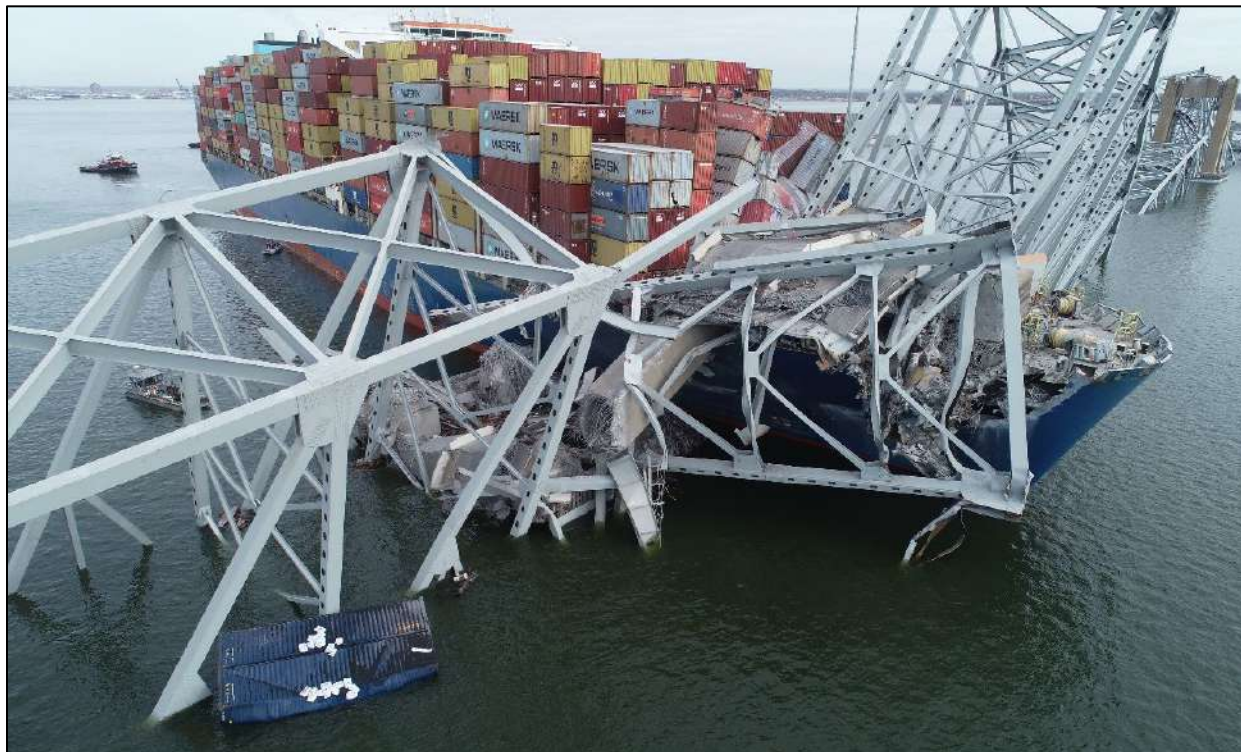

Figure 1. The *Dali*, with portions of the collapsed Key Bridge across its forward deck and in the Patapsco River, on March 28.

The US Coast Guard classified this accident as a major marine casualty.¹ The National Transportation Safety Board (NTSB), according to its Memorandum of Understanding with the Coast Guard, is the lead federal agency for the safety investigation, and, in response to the accident, traveled to Baltimore.

As part of the investigative process, the NTSB invited qualified parties to participate in the investigation. While they are not part of the analysis, parties are crucial in helping the NTSB develop the facts around an investigation. The following entities have agreed to serve as party to the *Dali* investigation:

- Synergy Marine Group
- Grace Ocean Private Limited
- Maryland Transportation Authority (MDTA)
- Federal Highway Administration

¹ A major marine casualty may include any one of the following: (a) the loss of six or more lives, (b) the loss of a mechanically propelled vessel of 100 or more gross tons, (c) property damage initially estimated to be \$500,000 or more, and (d) a serious threat, as determined by the Commandant of the Coast Guard with the concurrence of the National Transportation Safety Board Chair, to life, property, or the environment by hazardous materials.

- Association of Maryland Pilots
- Nippon Kaiji Kyokai (ClassNK)
- HD Hyundai Heavy Industries Co., Ltd
- Maritime & Port Authority of Singapore

The parties were formed into specialized investigative groups led by NTSB group chairs in the areas of nautical operations (ship handling, cargo, and navigation), engineering (propulsion and electrical), survival factors (search and rescue), bridge structures (design and protection), and recorders (electronic evidence). The Chair of the NTSB traveled with the investigative team and acted as the agency spokesperson.

In addition, the Singapore Transport Safety Investigation Bureau (TSIB), the Sri Lanka Merchant Shipping Secretariat, and the India Directorate General of Shipping are coordinating with the NTSB as representatives of the substantially interested states.²

1 Accident Events

1.1 *Dali*'s Main Propulsion System

The *Dali* was propelled by a single, slow-speed, 55,626-hp (41,480-kW) diesel engine manufactured by Hyundai MAN B&W (see figure 2). The engine was directly connected to a single, right-turning propeller.

To run the main engine, one of the vessel's four diesel generators must be operating and supplying the vessel with electrical power. The emergency generator alone cannot be used to restart or run the main engine.

The *Dali*'s main engine required compressed air directed into its cylinders to start and change direction. To change from ahead (moving forward) to astern

² According to International Maritime Organization Resolution [MSC.255\(84\)](#), a substantially interested state is a State: (1) which is the flag State of a ship involved in a marine casualty or marine incident; (2) which is the coastal State involved in a marine casualty or marine incident; or; (3) whose environment was seriously damaged by a marine casualty (including the environment of its waters and territories recognized under international law); (4) where the consequences of a marine casualty or marine incident caused, or threatened, serious harm to that State or to artificial islands, installations, or structures over which the State is entitled to exercise jurisdiction; (5) where, as a result of a marine casualty, nationals of that State have lost their lives or received serious injuries; (6) that has important information at its disposal that the marine safety investigating State(s) consider useful to the investigation; or (7) that for some other reason establishes an interest that is considered significant by the marine safety investigating State(s).

(moving in reverse), the engine would need to be stopped and then restarted in the opposite direction.

The engine was also fitted with alarms and automatic shutdown features to prevent damage to the engine if supporting systems required for its operation, such as the lubricating oil pump (which controls lubricating-oil pressure) or cooling water pump (which supplies a flow of cooling water), were lost. If a loss of electrical power occurred to either of these pumps, the engine would be shut down automatically. As part of a multistep sequence to restart and operate the main engine after a shutdown, the lubricating oil and cooling water pumps would need to be restarted.



Figure 2. Left: The *Dali*'s main engine room (looking aft), showing the vessel's engine. Right: NTSB investigators examining the lower level of the vessel's engine room (looking forward).

1.2 *Dali*'s Electrical Power Distribution System

The ship's electrical power was supplied by four alternating current generators, which were each driven by a diesel engine. Generator nos. 1 and 4 were rated for 4,400 kW, and generator nos. 2 and 3 were rated for 4,000 kW. The generators were connected to a 6,600-volt high-voltage (HV) main electrical bus by the vessel's power management system (see figure 3) that powered various shipboard equipment, including the main engine lubricating oil pumps, the bow thruster (a propulsor on the ship's bow that that assists with ship maneuverability), and reefer containers

(refrigerated containers that cool temperature-sensitive cargo).³ The HV main electrical bus could be split with an installed main bus tie (HVR in figure 5 on page 88), which would isolate two generators on each side of the bus. The bus was designed to be normally operated in a closed-bus configuration (meaning the main bus tie, which connected the two sides of the bus, was closed); this was the case during the accident voyage.

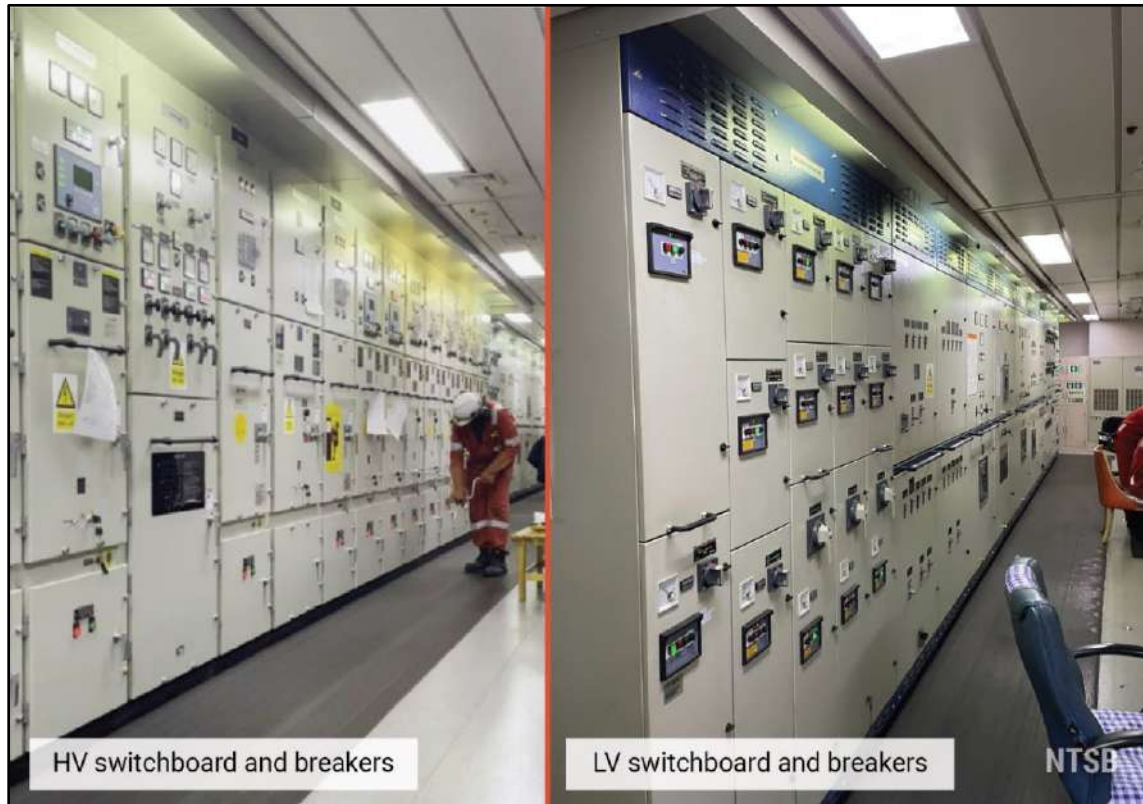

Figure 3. The *Dali*'s power management system in the ship's engine control room. The HV switchboard (which houses the HV bus) and breakers (*left*) and the LV switchboard (which houses the LV bus) and breakers (*right*).

A 440-volt low-voltage (LV) electrical bus was connected to the HV bus via redundant step-down transformers (TR1 and TR2 in figure 5). The LV bus powered vessel lighting and other equipment, including steering gear pumps and the main engine cooling water pumps. Breakers were located on either side of the step-down transformers—HR1 and HR2 on the HV side, LR1 and LR2 on the LV side. The LV bus

³ An *electrical bus* is a physical part of an electrical switchboard. (The term *bus* is a shortened form of *bus bars*, which are the metal bars physically located within the switchboard.) The bus connects the power produced by generators to systems/devices that require electrical power. Components such as circuit breakers and transformers help handle the electrical power that the bus distributes to the systems/devices requiring electrical power.

could also be split with an installed bus tie (LVR in figure 5). The bus was designed to be normally operated with the LV bus tie closed, which was the configuration during the accident voyage. With the LV bus tie closed, one transformer (TR1 or TR2) is designed to be used, with its associated HR and LR breakers (see figure 5).

1.3 Events of March 26

The following timeline depicts the events that occurred in the time leading up to the *Dali* striking pier no. 17 of the Key Bridge, the bridge's subsequent collapse, and initial search and rescue and recovery efforts for the road maintenance crewmembers (see figure 4).

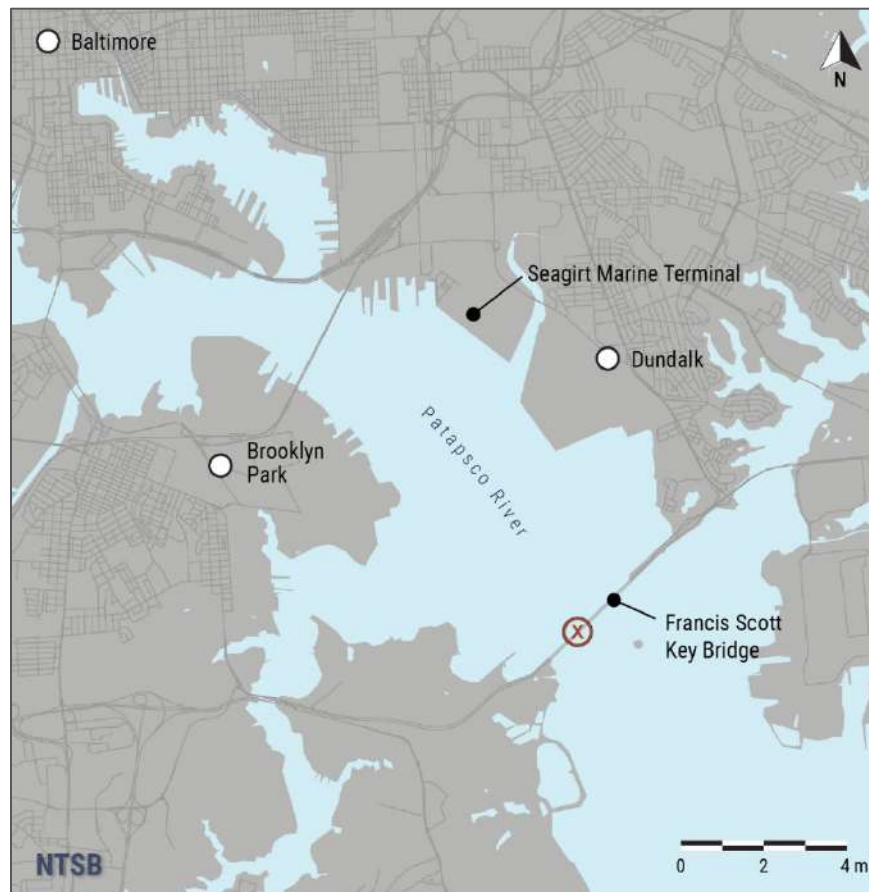

Figure 4. Area where the *Dali* struck the Key Bridge, as indicated by the red X. (Background source: Google Maps)

Around midnight on March 26, seven road maintenance workers and one inspector were working in the southbound lanes of the Key Bridge, which were closed to traffic. MDTA Police units were stationed at either end of the bridge to alternate traffic on the northbound lanes to protect the construction crew.

About 0005, an Association of Maryland Pilots senior pilot and an apprentice pilot boarded the *Dali*, which was about to depart from Seagirt Marine Terminal en route to Colombo, Sri Lanka, with a cargo of 4,680 containers (56,675 metric tons of containerized cargo). During the master/pilot exchange, the senior pilot asked about the vessel's condition, and the captain reported that the ship was in good working order.⁴

The *Dali* was assisted by two tugboats.

- The *Bridget McAllister*, a 78-foot-long, 5,080-hp tugboat with a 65-ton bollard pull, was secured on the *Dali*'s port quarter.⁵
- The *Eric McAllister*, a 98-foot-long, 5,150-hp tugboat with a 66-ton bollard pull, was secured on the *Dali*'s port bow.

About 0036, the two tugboats pulled the *Dali* away from the dock. About 0107, the vessel entered the Fort McHenry Channel. Generator nos. 3 and 4 were supplying electrical power to the vessel (see figure 5). All three steering pumps, which turned the ship's single rudder, were online.

⁴ A *master/pilot exchange* is required at the start of pilot transits and includes discussion of the vessel's navigational equipment, any limitations of maneuverability, available engine speeds, berthing maneuvers, intended course and speed through the waterway, anticipated hazards along the route, weather conditions, and composition of the bridge team and deck crew both forward and aft, including bow lookout.

⁵ *Bollard pull* is a measure of the pulling capability of a vessel at zero speed.

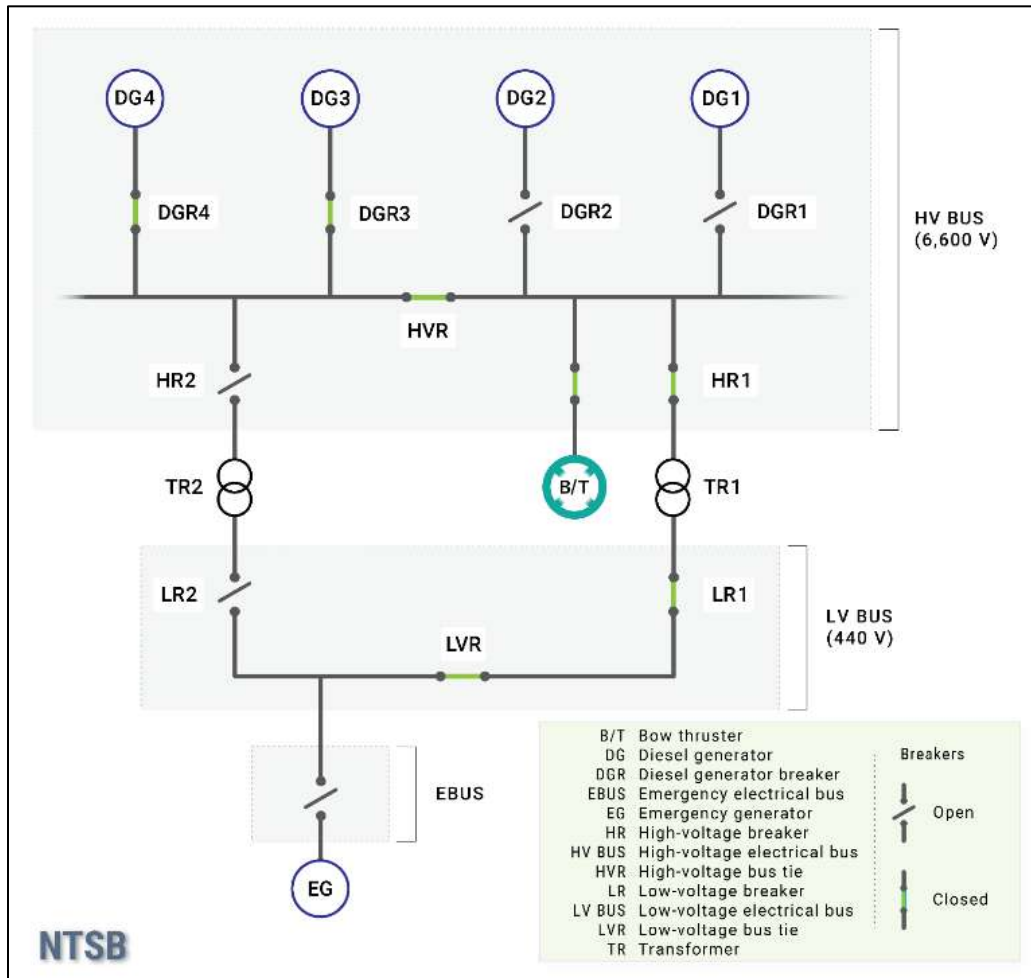

Figure 5. Simplified one-line electrical diagram of the *Dali* electrical power distribution system. Breakers shown reflect their positions at departure on March 26.

About 0045, the senior pilot ordered the main propulsion engine (a 55,626-hp [41,480-kW] diesel engine driving a single propeller) to “dead slow ahead.” Once in the channel, about 0107, the senior pilot also gave orders for the tugboats to be let go per normal practice. The senior pilot handed control over to the apprentice pilot and remained standing by. The ahead engine orders given during maneuvering would have generally corresponded to the estimated ship speeds (with the vessel loaded) in figure 6.

About 0109, the main engine’s speed was increased to “slow ahead.” The apprentice pilot ordered a course of 141° to transit under the Key Bridge.

Engine Telegraph (Ahead)	RPM	Estimated Ship's Speed (kts)	
		Loaded	Ballast
NAV FULL	80.05	21.9	23.5
FULL	60	16.8	18.1
HALF	53	14.5	15.7
SLOW	35	10.0	10.9
DEAD SLOW	27	8.1	8.8
STOP			

Figure 6. The *Dali*'s main engine maneuvering table, which shows ahead engine orders and the vessel's corresponding speeds under two operating conditions: loaded and ballast. The *Dali* was loaded when it departed.

About 0125, the *Dali* was 0.6 miles—or three ship lengths—from the Key Bridge when electrical breakers (HR1 and LR1) that fed most of the vessel's equipment and lighting unexpectedly opened (tripped) (see figure 7). This caused the first blackout (loss of electrical power) to all shipboard lighting and most equipment, including the main engine cooling water pumps (which controlled engine cooling water pressure) and steering gear pumps.

- Generator nos. 3 and 4 continued to run and supply electrical power to the HV bus.
- Most bridge equipment also lost power, and the voyage data recorder (VDR) lost vessel system data feeds. Bridge audio continued to be captured.

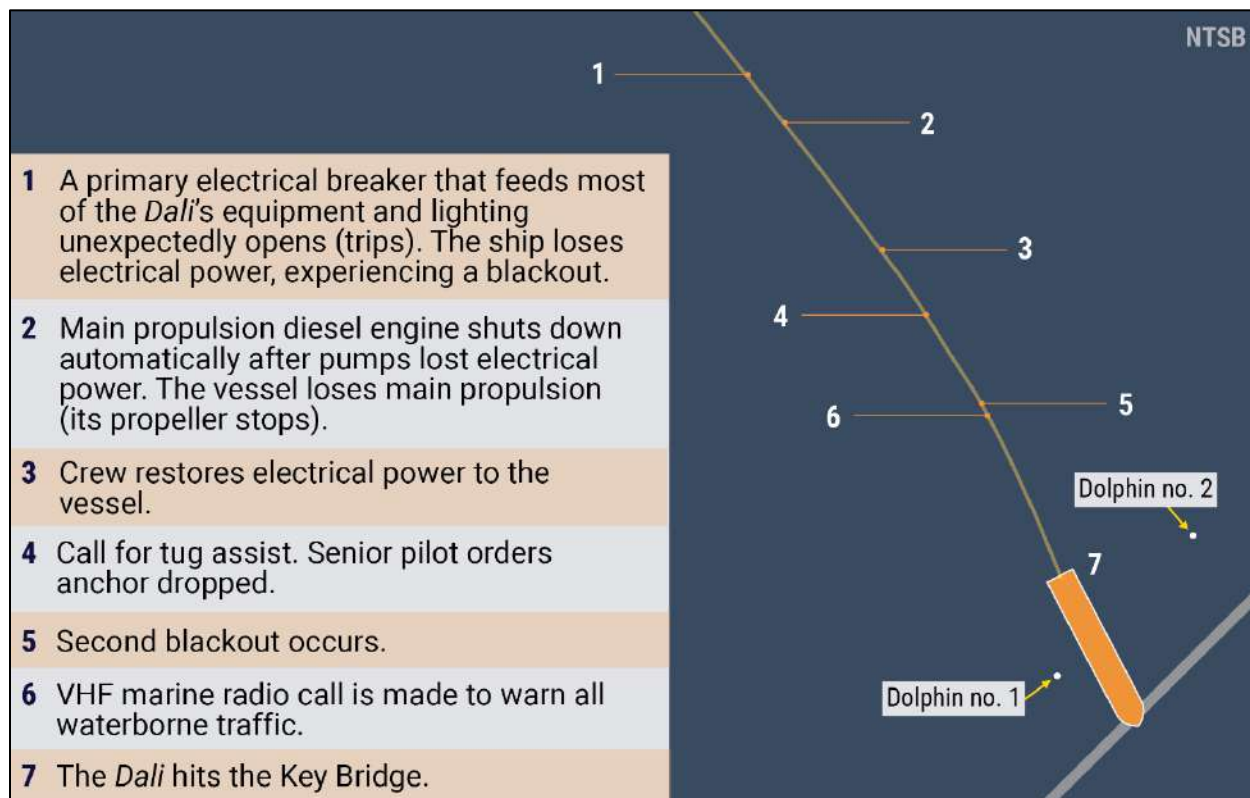

Figure 7. The *Dali*'s route on March 26, between the first blackout, and the *Dali* striking pier no. 17 of the Key Bridge. The location and approximate size of two of the bridge's "dolphins," sheet pile and concrete structures protecting the bridge's piers, are labeled in the lower right.

The main propulsion diesel engine was independent of the vessel's four diesel-driven electrical generators; however, the loss of electrical power to the pumps required for its operation resulted in the main engine being automatically shut down, and the vessel lost main propulsion, meaning its propeller stopped.

The loss of electrical power stopped all three steering pumps, and, therefore, the rudder was unable to be moved. At the time, the ship was on a heading of 141.7°, a course over ground of 140.8°, and speed over ground of 9.0 knots, with the rudder amidships (0°).

At 0126:02, the VDR, which had stopped recording vessel system data when the blackout occurred, resumed recording the data. The VDR audio recording had not been affected by the blackout. The *Dali*'s heading was 144.3° and course over ground was 142.7°. Its speed over ground was 8.6 knots. The apprentice pilot called the pilot dispatcher by mobile phone. At 0126:13, the senior pilot, who had regained control from the apprentice pilot by this point, ordered 20° of port rudder.

According to the crew, the emergency generator started and connected to the emergency bus (its breaker would have closed) shortly after the vessel lost electrical power. At this time, the NTSB is still investigating the exact time when the emergency generator started and connected to the emergency bus. Typical for oceangoing vessels, the *Dali* had an emergency diesel generator (in addition to the four generators) that could be configured to automatically start and connect to the emergency bus if normal electrical power and lighting were lost. When the emergency bus was powered, emergency lighting, navigation and radio equipment, alarms, and other emergency equipment would have been available, and the designated emergency steering pump (no. 3) would have been available to turn the rudder at its low-speed setting. (When operated alone using emergency electrical power, steering pump no. 3 was designed to run at a lower speed, turning the rudder at a slower rate than with all pumps.) However, without the propeller turning, the rudder would have been less effective.

- The crew manually closed breakers HR1 and LR1, reconnecting generator nos. 3 and 4 and restoring electrical power to the LV bus, supplying electrical power again to the entire vessel.

At 0126:39, the pilots called for tug assist. The *Eric McAllister* was 3 miles away and immediately answered, heading toward the ship (the tug did not reach the *Dali* before it struck the bridge).

At 0127:01, the senior pilot ordered an anchor dropped, and the crew began the process to drop anchor. The pilots' dispatcher called the MDTA Police duty officer and relayed that the ship had lost power. The pilots' dispatcher then notified the Coast Guard about the *Dali's* loss of power.

- The *Dali* crew was able to restore electrical power to the vessel, but, when the ship was 0.2 miles from the bridge, a second electrical blackout occurred because DGR3 and DGR4, the breakers that connected generator nos. 3 and 4 to the HV bus, opened, causing a total loss of vessel electrical power (HV bus and LV bus). Having connected to the emergency bus by this time, the emergency generator provided electrical power to the emergency equipment continuously through the second electrical blackout.
- Generator no. 2, which had previously started automatically because it was in standby mode, connected and restored power to the HV bus via DGR2.

At 0127:23, the pilot ordered the rudder hard to port (35°). At this point, the main engine remained shut down and there was no propulsion to assist with steering.

At 0127:25, one of the pilots made a call by very high frequency (VHF) marine radio to warn all waterborne traffic.

At 0127:32, about 31 seconds after the second blackout, the crew manually closed breakers HR2 and LR2, restoring power to the LV bus, which was powered by generator no. 2. (The crew regained electrical power before the vessel struck the pier but was unable to regain propulsion.)⁶

At 0127:53, the MDTA duty officer ordered the units stationed at the ends of the bridge to close the bridge to all traffic. Once the bridge was closed to traffic, only the maintenance crew and the inspector remained on the bridge.

At 0129:10, the *Dali's* starboard bow struck pier no. 17 of the Key Bridge at 6.5 knots. Six spans of the bridge (the main spans [17, 18, and 19] and spans 20, 21, and 22) subsequently collapsed into the water and across the ship's bow. A *Dali* crewmember, who was on the bow at the time of the accident, told investigators that, as he was releasing the brake on the port anchor, he had to escape from the falling bridge before he was able to reapply the brake. (Due to ongoing salvage efforts, the amount of anchor chain paid out is still unknown.)

As the bridge deck collapsed onto the bow of the *Dali*, another of the vessel's crewmembers sustained a minor injury while escaping the debris.

The road maintenance inspector had been walking the length of the bridge when the ship struck it. He ran north and made it to the nearest surviving span before the rest of the bridge collapsed. The other seven workers were in their vehicles and fell with the bridge. One worker was able to free himself from his truck and was rescued by an MDTA Police boat at 0155.

About 0134, the Coast Guard issued an urgent marine information broadcast, requesting assistance from passing traffic. The first Coast Guard boats were on scene about 0151.

Multiple agencies searched for survivors throughout March 26. The Coast Guard suspended the active search that evening, and efforts then transitioned to recovery. Six victims were later recovered by divers.

⁶ After the accident, the crew changed which generators supplied the vessel's electrical power. Generator electrical power was routed to the electrical systems only through HR2, TR2, and LR2 until April 9, when NTSB investigative parties and equipment manufacturer representatives began examining the electrical system. Testing is ongoing.

2 *Dali*

2.1 Background and Specifications

The *Dali*, a 947-foot-long, steel-hulled general cargo vessel (containership), was built by HD Hyundai Heavy Industries Co., Ltd. in 2015. The vessel's draft on departure was 39.9 feet fore and aft, with a cargo of 4,680 containers (56,675 metric tons of containerized cargo). The ship and cargo displaced 112,383 metric tons as loaded at departure.

Singapore-based Grace Ocean Private Limited, the vessel's owner, owns 55 ships—a mix of containerships (including *Dali*), bulk carriers, and tankers. As of March 26, Singapore-based Synergy Marine Group, the vessel manager who provided the crew and operated the vessel for the owner, managed 55 ships under Panama, Marshall Islands, Hong Kong, Liberia, and Singapore flags, including the *Dali*. The vessel was classed by ClassNK, one of several nongovernmental classification societies that establish and maintain standards for the construction and operation of ships. Through construction and later periodic surveys, classification societies confirm a vessel meets the class's technical rules.

2.2 US Port Calls in March 2024

Since arriving from Sri Lanka to the United States on March 19, the ship had made two other US port calls (Newark, New Jersey, from March 19 until March 21, and Norfolk, Virginia, from March 22 to March 23). On March 23, at 0236, the *Dali* moored at the Seagirt Marine Terminal in Baltimore Harbor.

2.2.1 Electrical Power Loss on Previous Day

On March 25, about 10 hours before leaving Baltimore, the *Dali* experienced a blackout (loss of electrical power to the HV and LV buses) during in-port maintenance.⁷ While working on the diesel engine exhaust scrubber system for the diesel engine driving the only online generator (generator no. 2), a crewmember mistakenly closed an inline engine exhaust damper. Closure of this damper effectively blocked the engine's cylinder exhaust gases from traveling up its stack and out of the vessel, causing the engine to stall. When the system detected a loss of power, generator no. 3 automatically started and connected to the HV bus.

Vessel power was restored when crewmembers manually closed HR2 and LR2. Generator no. 3 continued to run for a short period, but insufficient fuel pressure

⁷ The NTSB is not aware of any other vessel power outages occurring in Baltimore or while in its prior ports, Newark or Norfolk.

caused its speed to decrease, and its breaker (DGR3) opened; a second blackout (another loss of electrical power to the HV and LV buses) occurred. In the meantime, the crew had reopened generator no. 2's engine exhaust damper, and the generator automatically restarted and then connected to the HV bus when DGR2 closed.

While recovering from this second blackout, the crew switched the bus configuration to use breakers HR1 and LR1 and the bus's associated transformer (TR1) instead of breakers HR2 and LR2, which had been in use for several months. TR1 and its associated breakers, HR1 and LR1, were in use when the ship departed on March 26.

The first in-port blackout was caused by the mechanical blocking of the online generator's exhaust gas stack. The second blackout in port was related to insufficient fuel pressure for the online generator. During both of these electrical power-loss events, the online generators' breakers (DGR2 and DGR3) to the HV bus opened before the HR2 or LR2 breakers opened. During the recovery, the crew put TR1 online to feed the LV bus because TR2 had reportedly been in use for several months.

The first vessel blackout after departure on March 26 occurred when the HR1 and LR1 breakers opened unexpectedly.

The NTSB is still investigating the electrical configuration following the first in-port blackout and potential impacts on the events during the accident voyage.

2.3 Electronic Data

2.3.1 Voyage Data Recorder

International Maritime Organization rules require that vessels of 3,000 gross tons and above, constructed after July 1, 2014, and engaged on international voyages be equipped with a full VDR system. International Maritime Organization resolution MSC.333(90) requires that these vessels contain both a fixed and a float-free VDR capsule that record, at a minimum, 48 hours of data. Additionally, the VDR should store internal data of at least 30 days in the VDR's cabinet. The *Dali* was constructed in 2015 and contained a JRC JCY-1900 VDR.

Six hours of VDR data, which tracked events immediately before and after the accident, were downloaded and reviewed on March 26, immediately following the casualty. The VDR's hard drive from the VDR cabinet on the *Dali* was later removed and downloaded by NTSB personnel with the assistance of the VDR manufacturer. The hard drive contained 34 days of VDR data.

2.3.2 Other Data

Data from other bridge equipment, including the ship's electronic chart display and information system (ECDIS) and the pilots' portable pilot unit (PPU), were also downloaded. Review of this data continues.

2.3.3 Integrated Control and Monitoring System and High-voltage Electrical Bus

The *Dali* was equipped with an integrated control and monitoring system (ICMS) that retained information related to machinery and system changes and resulting alarms, including vessel engines and the electrical power management system. The NTSB has managed testing of the vessel's HV electrical bus and its components (including the HV and LV breakers) as the investigation parties and the electrical bus manufacturer, HD Hyundai Heavy Industries, Co. Ltd., work to identify the cause(s) of the breakers unexpectedly opening while approaching the Key Bridge and the subsequent blackouts (see figure 8).



Figure 8. An NTSB investigator examining the *Dali*'s HV switchboard (which houses the HV bus) and applying tamper-evident preservation seals.

2.4 Alcohol and Other Drug Testing

Coast Guard regulations require employers to conduct drug and alcohol testing for those directly involved in a “serious marine incident.”⁸ On March 26, at 0232, the *Dali* master and chief engineer tested the entire crew for alcohol, per company procedure. All tested negative.

At 0317, the senior and apprentice pilots were relieved by another pilot from the Association of Maryland Pilots. The two pilots were taken ashore where, at 0530, both were administered tests for alcohol and other drugs per Coast Guard regulations. Both tested negative.

Between 1617 and 1804, a third-party testing provider went aboard the ship to test the entire crew for alcohol and drugs, per Coast Guard regulations. All tested negative for both. The injured crewmember, who had been tested at 0232 with the rest of the crew, had already been taken ashore for medical treatment and was not tested by the third-party testing provider.

2.5 Fuel Testing

The ship used three main grades of fuel for the main engine and electrical generators: low-sulfur marine gas oil (LSMGO), low-sulfur heavy fuel oil, and heavy fuel oil. The *Dali* carried an estimated 1.8 million gallons of fuel in dedicated vessel fuel tanks. None of the vessel’s dedicated fuel tanks were damaged. The last time the *Dali* crew switched fuel was on the evening of March 21, 5 days before the accident, when they switched to burning LSMGO in all engines upon entering US territorial waters (12 miles off the Atlantic coast), as required by emission regulatory requirements.

The *Dali* took on various amounts of all three types of fuel in Newark, New Jersey, on March 19 after the month-long trip from Sri Lanka. Fuel-sample analysis results indicated that the LSMGO fuel bunkered in Newark, which was the same type of fuel in use during the accident events, complied with international standards and regulations. The test results did not identify any concerns related to the quality of the fuel.

On March 28, the owner took samples of the LSMGO that was being burned at the time of the accident. At NTSB direction, the owner transferred the samples to an independent laboratory. The test results did not identify any concerns related to the quality of the fuel.

⁸ [See Title 46 Code of Federal Regulations \(CFR\) 4.03-2–Serious marine incident.](#)

On April 11, additional fuel samples were taken from all fuel tanks and various fuel supply manifolds on board the vessel; samples were tested by an independent lab. Fuel-sample analysis results indicated that the LSMGO fuel being burned at the time of the accident complied with international standards and regulations. The test results did not identify any concerns related to the quality of the fuel.

2.6 Hazardous Materials

Of the 4,680 containers on board the vessel at the time of the accident, 56 were identified as containing dangerous goods (hazardous materials). The containers were located throughout the ship. The NTSB identified 14 containers, which were recorded as containing hazardous materials, that may have been damaged when the ship struck the Key Bridge or during the subsequent collapse of the bridge deck onto the ship (see figure 9 and table below). These 14 containers were all located forward of the superstructure, inboard in bays 5, 6, and 7.⁹

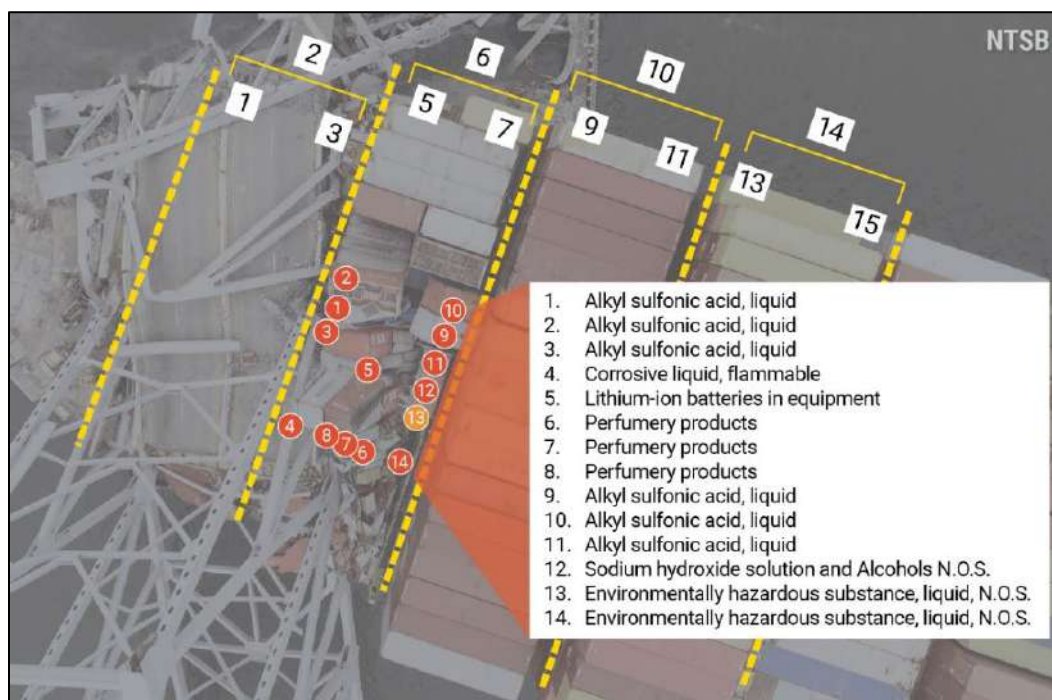

Figure 9. Approximate locations of cargo bays (yellow with numbers in white squares) and the 14 impacted hazardous materials shipping containers (orange circles with white numbers) transposed onto the *Dali* as seen after the accident. Hazardous material container no. 13 was in a portable tank, stored in the hold, below the deck.

⁹ A *superstructure* is the area on the main deck of a ship that houses crew stateroom accommodations and the galley. The ship's bridge sits atop the superstructure.

Table. Hazardous materials in potentially damaged containers.

Description	Quantity	No. of containers	Hazard class ¹
Alkyl sulfonic acids, liquids	128,000 kg	6	8 ²
Corrosive liquid, flammable	4,626 kg	1	8 (class 3 subrisk) ³
Environmentally hazardous substance, solid, N.O.S. (copper powder)⁴	6,804 kg	1	9 ⁵
Environmentally hazardous substance, liquid, N.O.S. (alkoxylated long-chain alkyl amine)⁶	18,270 kg	1	9
a. Sodium hydroxide solution	a. 10 kg	1	8
b. Alcohols N.O.S.	b. 174 kg	1	3
Perfumery products	7,016 kg	3	3
Lithium-ion batteries in equipment	922 kg	1	9

Notes:

1. See [Title 49 Code of Federal Regulations \(CFR\) Part 173–Shippers–General Requirements for Shipments and Packagings](#).
2. Class 8 materials are corrosive materials.
3. Class 3 materials are flammable and combustible liquids.
4. N.O.S. means “not otherwise specified.” See [49 CFR 172.101–Purpose and use of hazardous materials table](#).
5. Class 9 materials are miscellaneous hazardous materials.
6. In a portable tank. Stored below deck.

The *Dali* master activated the vessel response plan at 0212 the morning of the accident by contacting crisis and emergency management firm Witt O’Brien’s, the qualified individual.¹⁰ Resolve Marine responded as salvor, and Marine Spill Response Corporation responded as the oil spill response organization according to the vessel response plan. The Coast Guard additionally deployed its Atlantic Strike Team and its Salvage Engineering Response Team. The US Army Corps of Engineers and the US Navy Supervisor of Salvage and Diving, among many other agencies, also responded. Responders deployed containment boom around the ship, conducted

¹⁰ A *vessel response plan* is a document that establishes vessel information for use during an oil spill (or if the threat of oil discharge or other unresolved hazardous conditions is present). Information includes designated shore-based resource providers, such as oil spill management and salvage, and procedures for notifying them. A qualified individual is trained in the responsibilities of implementing a vessel response plan.

atmospheric monitoring, and plugged the deck scuppers.¹¹ According to the Unified Command, no hazardous material from containers has reached the water. Salvors are transferring the bulk liquid acid to intact tanks and moving containers ashore.

3 Francis Scott Key Bridge

3.1 Background

The Francis Scott Key Bridge was owned and operated by MDTA and was opened to traffic on March 23, 1977, and carried Maryland 695 over the Patapsco River, running from Baltimore to Dundalk, Maryland. The approximately 9,087-foot-long, steel and concrete bridge was comprised of a continuous steel through-truss located over the river's navigation channel; the north and south approaches of the bridge consisted of multibeam plate girder spans (see figure 10). The continuous through-truss main spans of the bridge had a total length of about 2,643 feet and consisted of a 1,200-foot-long main span and two 721.5-foot-long back spans. The main span's navigation vertical clearance was 185 feet, and its navigation horizontal clearance (between the supporting piers) was about 1,100 feet.

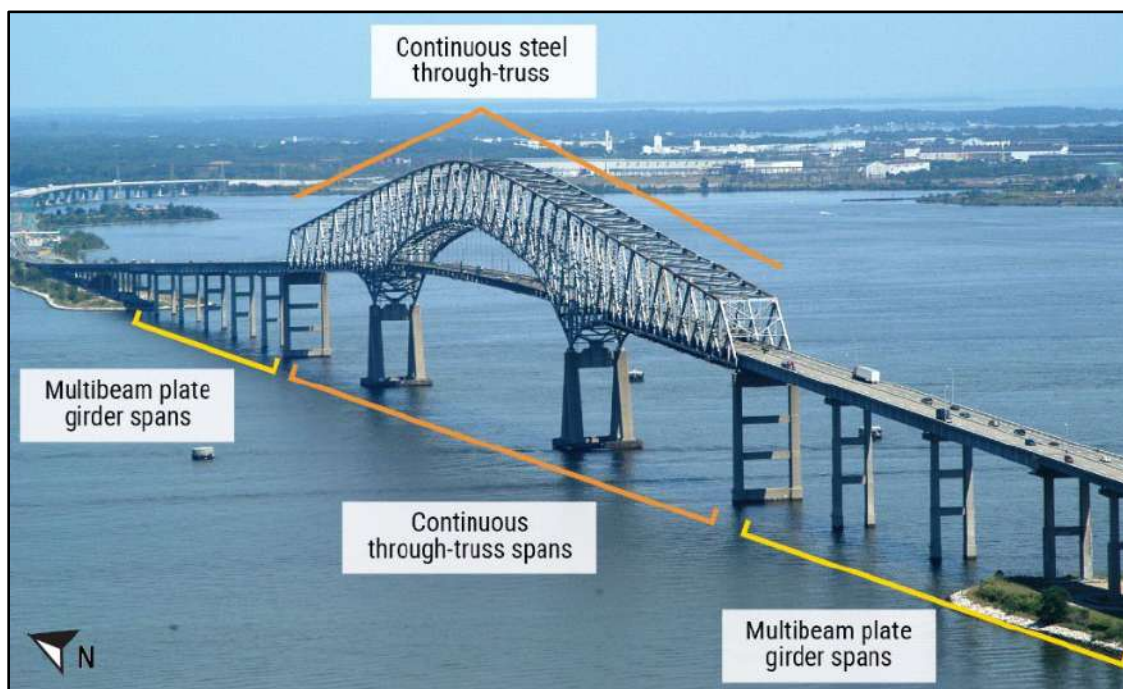

Figure 10. The Key Bridge with its truss and spans labeled. (Background source: MDTA)

¹¹ (a) A *containment boom* is a temporary floating barrier extended used to contain an oil spill. *Atmospheric monitoring* is the monitoring of an area's air to detect concentrations of certain gases. (b) A *scupper* is an opening cut through a ship's bulwarks (vertical plating that extends the side of the ship above its weather decks) that allows water collecting on a weather deck to flow overboard.

At the time of the collapse, the Key Bridge consisted of four total travel lanes (two northbound and two southbound). The annual average daily traffic for calendar year 2023 was 34,121 vehicles per day, with trucks comprising 10% of traffic.¹²

3.2 Pier Protection

When the Key Bridge was constructed, four large dolphins—two located on the west side of the bridge and two located on the east side of the bridge—were also constructed at the same time to protect pier nos. 17 and 18 supporting the bridge’s central through-truss spans. Dolphin no. 1 was about 491 feet west of the center of pier no. 17 and 550 feet clear of the centerline of the navigational channel (see figure 11). The dolphins were constructed with a 25-foot-diameter sheet pile filled with tremie concrete and capped with reinforced concrete (see figure 12). Attached at various locations on the dolphin were 17-foot-long rubber fenders.

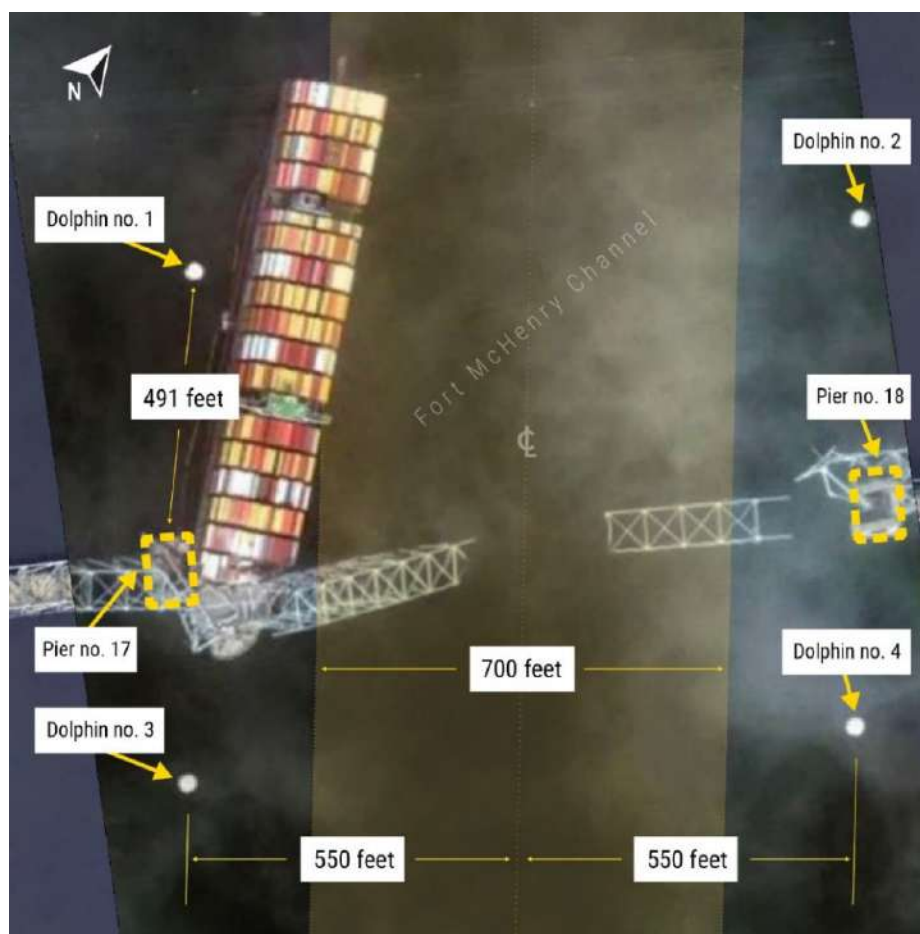

Figure 11. Locations of dolphins relative to the *Dali*, the Key Bridge, and Fort McHenry Channel. (Background sources: MAXAR and Google Earth)

¹² Recent traffic data provided by the MDTA.

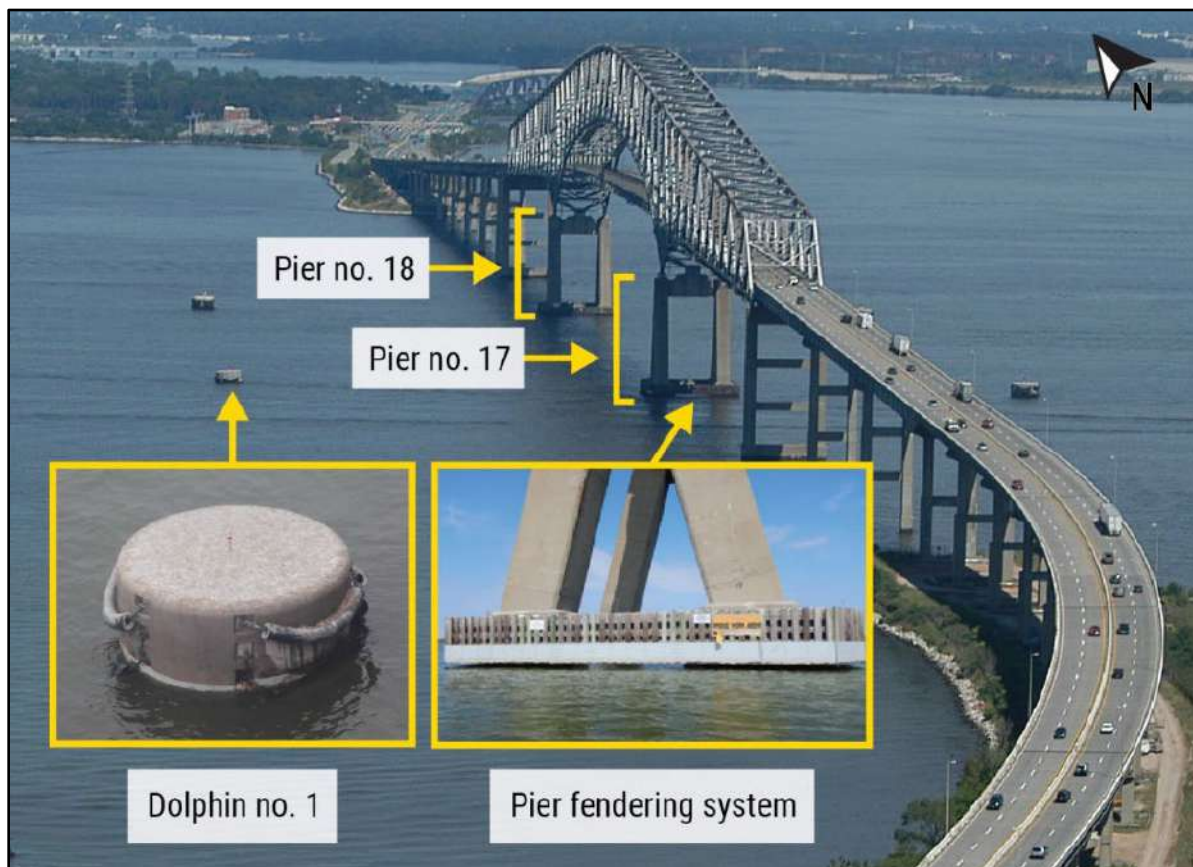

Figure 12. The Key Bridge and the locations of pier nos. 17 and 18. Insets show dolphin no. 1 as well as pier no. 17's fendering-system surrounding. (Background source: MDTA)

In addition to the dolphins, pier nos. 17 and 18 were each surrounded by a 100-foot-by-84.5-foot crushable concrete box and timber fender system, as seen in figure 12. These systems were comprised of hollow, thin-walled, concrete box structures attached to the piers. The timber portions of the fender were attached to the outer face of the concrete box and utilized a combination of vertical and horizontal members. Additionally, steel plates were secured at the base of the vertical timber members.

The *Dali* struck pier no. 17 and the fendering system surrounding the pier but did not contact dolphin no. 1 or its rubber fenders. Both fendering systems surrounding pier nos. 17 and 18 were further damaged during the collapse of the truss spans of the bridge when components of the truss spans impacted portions of the fenders as the components fell into the water.

3.3 Bridge Inspections and Condition

The Key Bridge was subject to regular inspections in accordance with the National Bridge Inspection Standards.¹³ These periodic inspections are intended to maintain safe bridge operation and prevent structural and functional failures. In addition to routine bridge inspections, the bridge's steel-truss design and location over the Patapsco River required two additional types of inspections be performed. One of these additional inspections focused on the nonredundant steel tension members within the steel truss, and the other examined the bridge's underwater members.¹⁴ The last inspection of the nonredundant steel tension members was completed in May 2023, and the last underwater bridge inspection was completed in March 2021. Data from these inspections and the routine inspections were entered into the Federal Highway Administration National Bridge Inventory (which records bridge inventory and condition data collected from states, federal agencies, and tribal governments) indicating that bridge inspectors rated the conditions of the deck, the superstructure, and the substructure as being in satisfactory condition.

4 Ongoing Activities

The NTSB will continue evaluating the design and operation of the *Dali*'s power distribution system (including its breakers). Examination of damage to the vessel will continue when the ship is clear of debris and moved to a shoreside facility.

The NTSB is working with parties to immediately assess their bridges and determine whether pier protection needs to be improved. Specifically, the MDTA is studying short-term and long-term options for upgrades to the existing protection system for the eastbound and westbound spans on the Gov. William Preston Lane Jr. Memorial Bridge (commonly known as the Bay Bridge) near Annapolis.

The NTSB is examining the pier protection improvements that have been made on the following bridge collapses resulting from marine vessel strikes that the NTSB has investigated: the Sunshine Skyway Bridge in Tampa Bay, Florida; Queen Elizabeth Causeway Bridge near South Padre Island, Texas; and the I-40 Bridge near Webbers Falls, Oklahoma.

¹³ [23 CFR Part 650 Subpart C–National Bridge Inspection Standards.](#)

¹⁴ A *nonredundant steel member* is a primary steel member fully or partially in tension, and without load path redundancy, system redundancy, or internal redundancy, whose failure may cause a portion of or the entire bridge to collapse; see [23 CFR 650.305–Definitions.](#) In 2022, the Federal Highway Administration started using the term *nonredundant steel tension member*, replacing the previous term *fracture critical member*.

Interviews, including with bridge experts, waterways management personnel, marine safety and highway regulators, and vessel operators, are planned.

Detailed analysis of the VDR bridge audio and further validation of VDR parameters continues.

Planned areas of investigation include oceangoing vessels' propulsion and electrical systems; the frequency and causes of vessel contacts with bridges over navigable waters; and bridge-strike mitigation measures such as a combination of vessel-size restrictions, vessel-assist tugs, and bridge-pier protection.

The NTSB investigation of all aspects of the accident is ongoing as we determine the probable cause.

Dali

Owner	Grace Ocean Private Limited
Operator	Synergy Marine Group
Flag	Singapore
Builder	HD Hyundai Heavy Industries Co., Ltd.
Build year	2015
IMO No.	9697428
MMSI	563004200
Call Sign	9V5283
Destination	Colombo, Sri Lanka

Meteorological Information

Sky	Overcast
Water temperature	48°F / 9°C
Light	Night
Observation time	0216 local time (eastern daylight time)
Air temperature	39°F / 4°C
Wind speed and direction	2 kts (calm)
Visibility	10 mi

Wreckage Information

Vessel crew injuries	1
Vessel passenger injuries	None
Ground injuries	7 (6 fatal)
Total injuries	8 (6 fatal)
Damage	Substantial
Fire	None
Explosion	None
Latitude	39°12.99' N
Longitude	76°31.75' W

Investigation

Investigator in charge	Marcel Muise
Additional participating parties	Synergy Marine Group, Grace Ocean Private Limited, Maryland Transportation Authority (MDTA), Federal Highway Administration, Association of Maryland Pilots, Nippon Kaiji Kyokai (ClassNK), HD Hyundai Heavy Industries Co., Ltd, and Maritime & Port Authority of Singapore
Substantially interested states	India Singapore Sri Lanka
Note	The NTSB travelled to the scene of this accident.